

eman ta zabal zazu



Universidad del País Vasco Euskal Herriko Unibertsitatea

Departamento de Geografía, Prehistoria y Arqueología  
Doctorado en Cuaternario: Cambios ambientales y huella humana

## Tesis Doctoral

**Evaluación arqueológica del proceso de lateralización.  
Determinación cuantitativa de la lateralidad poblacio-  
nal, desde los neandertales hasta la actualidad**

**Archaeological assessment of the lateralization process.  
Quantitative determination of population-level handed-  
ness, from the Neanderthals to present day**

Tesis para optar al grado de doctor internacional  
Presentada por:

**EDER DOMINGUEZ BALLESTEROS**

Dirigida por:  
Alvaro Arrizabalaga Valbuena  
Ignacio Martínez Mendizabal

**Vitoria-Gasteiz, 2016**





A mi familia: aita, ama, Mikel, Duk y  
Sukoiak.



## **Agradecimientos:**

En primer lugar me gustaría agradecerle a mi familia el apoyo constante e incondicional. No solo el apoyo económico, que lo ha habido y es importante, sino también el apoyo moral que para mí ha sido determinante. Aita y ama, siempre me habéis animado a que estudiara lo que yo quisiera y aquí estoy, mirando piedras. A Mikel el estar siempre ahí, como mi mejor hermano y mi mejor amigo.

En segundo lugar me gustaría agradecer a mis dos magníficos directores de tesis todo lo que han hecho para que esta tesis salga adelante. A Alvaro por creer en este proyecto desde el principio, a pesar de que la idea sonara un poco atípica y porque, a pesar de considerarme un cronófago voraz, siempre has tenido un hueco para resolver una duda o tender una mano. Además, al margen de la tesis, he compartido contigo mis penas y alegrías y en muchos momentos has sido un amigo, no un director. A Nacho porque, a pesar de solo estar en el principio y final del proyecto, tu ayuda ha sido clave y me la has prestado muy amablemente. Por tu vuestra, cercanía, humildad y sabiduría, es un lujo trabajar junto a vosotros. También quiero agradecer en especial a mis dos directores de estancia Alain Turq, que me acogió en el Museo Nacional de Prehistoria de Les-Eyzies, y a Natalie Uomini, que me acogió en la Universidad de Liverpool y me ha enseñado muchísimo sobre la lateralidad.

También quiero mostrar mi agradecimiento a todos los que me han acompañado durante mi corta vida académica: a mis profesores y compañeros de clase de la Licenciatura de Geología y del Master en Primatología, y a todos y cada uno de los miembros del Departamento de Geografía, Prehistoria y Arqueología de la UPV/EHU, que de alguna manera u otra habéis aportado algo a esta tesis. En concreto, a todos aquellos que me habéis enseñado a trabajar en el campo y que habéis sido mis directores en diferentes excavaciones arqueológicas: Javier Fernandez Eraso, Andoni Tarrío, Maite García-Rojas, Aitor Calvo, Marcel Bradtmöller, Joseba López de Ocariz, Cristina Camarero, Eric Arévalo, Marcos Díaz, Michel Berjón, Joseba Ríos y en especial a Alvaro Arrizabalaga y Maria Jose Iriarte, con los que he compartido muchísimas horas de campo. También a todos aquellos compañeros de excavación, en especial a los de Lezetxiki, con los que he disfrutado de horas de campo y de los cuales he aprendido mucho compartiendo, codo con codo, sector, cuadro, guitarra y litrona. También a Maite García-Rojas por introducirme en el mundo de la talla experimental, a Maite Iris García por ayudarme con el inglés, a Judit López de Heredia y a Blanca Ochoa por ayudarme con la burocracia, y a Jaione Agirre, Diego Garate, Sonia Aníbarro y en general a todos los miembros del Museo Bibat de Vitoria-Gasteiz y el Arkeologi Museoa de Bilbao, por ayudarme en la consulta de materiales.

Quiero agradecer de manera muy especial a aquellos que habéis participado activamente en esta tesis. A mis zurdos favoritos, Eduardo Cerdá, Asier Abaunza, Blanca Ochoa, Arantzazu Jindriska Pérez y Cristina Camarero y a mis estupendos diestros, Alejandro Prieto, Aitor Calvo, Aitor Sánchez, Martin Arriolabengoa, Miren Ayerdi, Beñat Artabe, Amaya Echazarreta y Ainhoa Aranburu, que me ayudaron con la parte experimental. A todos vosotros mil gracias, sin vosotros, literalmente, esta tesis no hubiera sido posible.

Además, he tenido la suerte de encontrarme en el mundo de la arqueología, y en particular en el Departamento de Geografía, Arqueología y Prehistoria, gente que además de ser investigadores de primera, son muy buenos amigos. Por eso, quiero agradecer en especial a mis colegas: Asier Abaunza, Aitor Calvo, Aitor Sánchez, Alejandro Prieto, Joseba López de Ocariz, Unai Perales y Lorea Burzako. Especialmente a los cuatro últimos, con los que aparte de compartir profesión, he compartido hogar. Gracias por que, a pesar de que me conocéis, me queréis.

Por último, y fuera ya de todo este mundo de las piedras, quiero agradecer desde muy dentro de mi corazón al mejor talde de la historia mundial. Ya sé que no hace falta decirlo, pero me refiero a Sukoia. Sin vosotros no podría haber hecho la tesis porque sin vosotros no daría ni un paso en firme. No hace falta que os diga que sois los mejores y que habéis aportado muchísimo a esta tesis con debates, consejos y críticas. Con vosotros me hice científico, con vosotros me hice persona. Descubrimos juntos la difracción de la luz construyendo “televisiones” en la caseta, la gravedad haciendo puestos de vigías e invernaderos en los árboles y la electricidad y su poder colgando bicis de... bueno ya sabéis de dónde. Aprendí el valor de la verdad y a ser honesto en numerosas discusiones (numerosas). Aprendí la dialéctica y la argumentación, el empirismo y la falsación, a hablar y a escuchar. Me disteis el don de ser sukoiano y os estaré eternamente agradecido, a todos y cada uno de vosotros.

**Pum-pum-llama.**



## Resumen:

Los útiles prehistóricos constituyen una fuente de información muy valiosa para conocer cómo era la vida de nuestros antepasados, pero también para entender cómo se comportaban y cómo pensaban. Debido a que es la mente la que crea el útil, podemos tratar de obtener información sobre la cognición humana a través del estudio de las industrias líticas. Por ello, el estudio de los útiles prehistóricos se puede completar con análisis que incluyan enfoques etológicos y cognitivos que permitan extraer información adicional a la que obtenemos de un estudio puramente tipológico. Siguiendo este razonamiento, en las últimas décadas se han incrementado los estudios que analizan la lateralidad de las poblaciones prehistóricas a través de la industria lítica. La lateralidad es una cualidad que presentan algunas especies y que consiste en asignar roles diferentes a cada lado del cuerpo en el momento de realizar una tarea determinada, otorgando a uno de ellos mayor dominancia. Estos estudios tratan de aportar información al conocimiento de las asimetrías cerebrales y al desarrollo del lenguaje durante nuestra evolución ya que guardan una fuerte relación con la lateralidad.

En esta tesis partimos del estudio de sociedades prehistóricas del Neolítico y Calcolítico, que nos permiten analizar cómo influyen los factores culturales en la lateralidad poblacional, para continuar analizando sociedades formadas por neandertales. Para ello, hemos desarrollado dos métodos. El primero nos ha permitido deducir la lateralidad de un productor de hachas a partir de la morfología del corte de un hacha pulida, aplicable a materiales neolíticos y calcolíticos, y el segundo nos ha permitido establecer la lateralidad del tallista a partir de las lascas, mediante el análisis de unas fracturas que en ocasiones se desarrollan en torno al punto de percusión, denominadas fracturas parabólicas. A partir de estos métodos hemos establecido los niveles poblacionales de lateralidad en diferentes momentos de la prehistoria, y su comparación con los niveles poblacionales actuales de diferentes sociedades nos han permitido entender mejor las asimetrías cerebrales, su evolución y su relación con el lenguaje.

## Abstract:

Prehistoric tools are a valuable source of information for understanding how our ancestors lived, but also for understanding their behavior and how they thought. Because it is the mind that creates the tool, we can try to obtain information about human cognition through the study of the lithic industries. For this reason, the study of prehistoric tools can be complemented with analyzes that include ethological and cognitive approaches that allow us to extract additional information from what we obtain from a purely typological study. Following this reasoning, in the last decades the studies that analyze the laterality of the prehistoric populations through the lithic industry have increased. Laterality is a quality that some species present to assign different roles to each side of the body at the time of performing a given task, giving one of them greater dominance. These studies try to contribute information to the knowledge of the cerebral asymmetries and to the development of the language during our evolution, since language has a strong relation with laterality.

In this thesis we start with the study of prehistoric societies of the Neolithic and the Chalcolithic, which allow us to analyze how the cultural factors influence the population-level laterality, to continue analyzing societies formed by Neanderthals. To do this, we have developed two methods. The first one allowed us to infer the laterality of an axe producer attending to the morphology of the cutting edge of a polished axe, applicable to Neolithic and Chalcolithic materials, and the second allowed us to establish the laterality of the knapper based on the flakes, analyzing a fractures that sometimes develop around the point of percussion, called parabolic cracks. Based on these methods we have established population levels of laterality in different moments of prehistory, and their comparison with the current population levels of different societies have allowed us to better understand cerebral asymmetries, their evolution and their relationship with language.



## Índice:

Chapter 1: Introduction .....	13
Capítulo 2: Antecedentes y estado de la cuestión .....	21
2.1 Definición de lateralidad .....	23
2.2 Bases fisiológicas de la lateralidad .....	24
2.2.1 Estructura general del encéfalo .....	25
2.2.2 Asimetrías cerebrales .....	27
2.3 Lateralidad en animales no primates .....	34
2.4 La lateralidad y dominancia manual en primates no humanos .....	37
2.5 Lateralidad y dominancia manual en humanos .....	41
2.5.1 Origen de la lateralidad .....	42
2.5.1.1 Origen genético de la lateralidad .....	42
2.5.3 Origen evolutivo de la lateralidad .....	44
2.5.2 Lenguaje, lateralidad y dominancia manual .....	48
2.5.3 Diferencias geográficas, por status socio-económico y por género de la lateralidad manual .....	50
2.6 Arqueología cognitiva: Lateralidad y dominancia manual a partir de materiales arqueológicos .....	55
2.7 Otras formas de inferir la lateralidad en humanos prehistóricos .....	59
2.8 Recapitulación	53
Chapter 3: Methodology .....	69
3.1. Introduction	71
3.2. Laterality through the polished axes .....	74
3.2.1 Introduction and etnoarchaeologic background .....	75
3.2.2 Experimental programme .....	78
3.2.2.1 Materials .....	79
3.2.2.2 Individuals .....	80
3.2.2.3 Procedure .....	81
3.2.3 Application of the method .....	82
3.2.4 Experimental results .....	86
3.2.5 Discussion of the results .....	92
3.3. Laterality through the flakes .....	94
3.3.1 Previous studies .....	95
3.3.2 Experimental programme .....	99
3.3.2.1 Materials and Methods .....	104
3.3.2.2 Development of the “parabolic crack” under the percussion with different materials .....	104
3.3.2.3 Empirical observation .....	115
3.3.2.4 Experimental testing .....	115
3.3.3 Application of the method .....	125
3.3.4 Experimental Results .....	128
3.3.5 Discussion of the results .....	129
3.4 Sample size .....	131
3.4.1 Population size .....	132

3.4.2	Estimated proportion .....	132
3.4.3	Margin of error and Confidence intervals.....	134
3.4.4	Conclusion .....	135
Capítulo 4:	Materiales y resultados .....	137
4.1	Introducción .....	139
4.2	Materiales.....	140
4.2.1	Neolítico y Calcolítico .....	140
4.2.1.1	Bizkaia.....	141
4.2.1.2	Álava, Treviño y Navarra.....	145
4.2.2	Paleolítico .....	149
4.2.2.1	Le Moustier .....	150
4.2.2.2	Vaufrey .....	155
4.2.2.3	Axlor .....	160
4.3	Resultados del estudio de la lateralidad en materiales arqueológicos.....	168
4.3.1	Sociedades productoras .....	168
4.3.2	Sociedades cazadoras-recolectoras.....	173
Chapter 5:	Discussion .....	179
5.1	Introduction .....	181
5.1.1	Importance of the study of laterality .....	184
5.1.2	Measuring handedness.....	185
5.1.3	Laterality in past societies .....	188
5.2	Laterality observed in polished stone axes .....	189
5.2.1	Discussion on the method .....	190
5.2.2	Discussion on the results.....	191
5.2.3	Discussion on the application of the method.....	193
5.3	Laterality observed through lithic flakes.....	194
5.3.1	Discussion on the method .....	199
5.3.2	Discussion on the application of the method.....	201
5.3.3	Discussion of the results .....	203
5.4	General discussion .....	204
Chapter 6:	Conclusions.....	207
6.1	Conclusions regarding the polished stone axe method .....	209
6.2	Conclusions about the lithic flake method.....	210
6.3	Conclusions about the results.....	211
6.4.	Importance of the research for future studies on laterality in Prehistory .....	214
6.5.	Other contributions.....	216
Bibliografía.....		219
Anexo I .....		269
Hachas experimentales.....		273
Archaeological axes .....		289



Índice de figuras:

Figura 1.1 .....	17
Figura 2.1 .....	25
Figura 2.2 .....	26
Figura 2.3 .....	26
Figura 2.4 .....	27
Figura 3.1 .....	77
Figura 3.2 .....	80
Figura 3.3 .....	81
Figura 3.4 .....	82
Figura 3.5 .....	83
Figura 3.6 .....	83
Figura 3.7 .....	84
Figura 3.8 .....	84
Figura 3.9 .....	92
Figura 3.10 .....	93
Figura 3.11 .....	97
Figura 3.12 .....	100
Figura 3.13 .....	101
Figura 3.14 .....	102
Figura 3.15 .....	105
Figura 3.16 .....	108
Figura 3.17 .....	109
Figura 3.18 .....	114
Figura 3.19 .....	116
Figura 3.20 .....	117
Figura 3.21 .....	118
Figura 3.22 .....	119
Figura 3.23 .....	120
Figura 3.24 .....	121
Figura 3.25 .....	122
Figura 3.26 .....	126
Figura 3.27 .....	127
Figura 3.28 .....	134
Figura 4.1 .....	141
Figura 4.2 .....	150
Figura 4.3 .....	151
Figura 4.4 .....	155
Figura 4.5 .....	156
Figura 4.6 .....	157
Figura 4.7 .....	160
Figura 4.8 .....	161
Figura 4.9 .....	172
Figura 4.10 .....	176
Figura 4.11 .....	177
Figura 5.1 .....	188

Figura 5.2.....	190
Figura 5.3.....	196
Figura 6.1.....	212

Índice de tablas:

Tabla 2.1	
Tabla 3.1.....	80
Tabla 3.2.....	86
Tabla 3.3.....	92
Tabla 3.4.....	101
Tabla 3.5.....	107
Tabla 3.6.....	109
Tabla 3.7.....	125
Tabla 3.8.....	129
Tabla 3.9.....	133
Tabla 3.10.....	134
Tabla 4.1.....	144
Tabla 4.2.....	148
Tabla 4.3.....	154
Tabla 4.4.....	155
Tabla 4.5.....	159
Tabla 4.6.....	163
Tabla 4.7.....	164
Tabla 4.8.....	165
Tabla 4.9.....	166
Tabla 4.10.....	167
Tabla 4.11.....	168
Tabla 4.12.....	171
Tabla 4.13.....	174
Tabla 4.14.....	174
Tabla 4.15.....	175
Tabla 4.16.....	175
Tabla 4.17.....	177
Tabla 5.1.....	182
Tabla 5.2.....	184
Tabla 5.3.....	187
Tabla 5.4.....	188
Tabla 5.5.....	200
Tabla 5.6.....	203
Tabla 5.7.....	205
Tabla 6.1.....	212
Tabla 6.2.....	213

Chapter 1:  
**Introduction**



Animals generally possess bilateral symmetry although some species, including human beings, are also able to assign different roles to each side of the body carrying out a particular task. This ability is known as laterality. Although other species display laterality, it is only in humans that it is seen clearly and at populational level. In the case of human beings, right-handed individuals assign a dominant role to their right hand and left-handed individuals to their left hand, in order to carry out a particular task. In the second half of the twentieth century, an increasing number of studies attempted to measure handedness in modern populations and tried to understand the genetic mechanisms that determine whether an individual is right or left-handed. Several genetic models were established. However, studies undertaken in populations with noticeable cultural differences have shown that, as the variability is large, some type of cultural-environmental mechanism must also exist, and depending on the difficulty of the task, and whether it involves the use of a tool, the levels of laterality within the same population may vary. Additionally, other questions are posed by laterality: when did we acquire the capacity to assign different roles to each limb for complex tasks? How has laterality varied in the course of evolution?

The main objective of this thesis is precisely to determine how cultural and environmental factors and the genetic factor influence handedness in a population through the study of prehistoric societies, and to what extent the cultural differences between modern industrial or non-industrial societies and prehistoric farming societies may alter the levels of population laterality. It will also attempt to determine the levels of populational laterality in Palaeolithic societies, formed by individuals of another species (*Homo neanderthalensis*) and understand how cultural and genetic differences influence population-level laterality. To do this, a model has been developed to determine handedness through two types of archaeological remains. Two types of prehistoric societies have been studied: farming communities and hunter-gatherer groups. In this first case, the method has been based on the study of polished stone axes, by measuring the deviation of the cutting edge. For hunter-gatherer societies, the fractures that appear on the butts of flakes, called parabolic cracks, have been studied. The largest part of this research, and the one that has taken most time, has consisted of developing these two methods. However, they were then applied to Neolithic and

Chalcolithic remains from Biscay, Álava and Navarre and to two archaeological levels at Le Moustier, one at Grotte Vaufrey and the complete sequence of the old excavations at Axlor.

The initial hypothesis, based on the studies of modern populations, is that despite the genetic influence, culture and/or environment can affect laterality ratios at a populational level. We would expect to find population-level laterality in prehistoric societies that are similar to those in modern non-industrialised societies, and significantly lower than those in industrialised societies today.

First of all, the thesis begins with a review of the literature on modern societies, both industrialised and non-industrialised. Once the parameters have been established for population-level laterality in the different types of societies now living in the world, prehistoric societies are studied. For studies of laterality in modern populations, data are obtained by questionnaires and the observation of certain tasks. These two methods are obviously unfeasible in studies on laterality in past societies. One of the approaches to population-level laterality in a prehistoric population is to study the evidence allowing us to deduce how a particular task was performed. In this sense, archaeological objects that are the result of a given task (knapping, polishing, etc.) or were used for a particular task (cutting, scraping, etc.) may provide information about the handedness of the maker or user of the objects, with the circumstance that their abundance and presence in time and space can provide a sample that a priori is appropriate to extract quantifiable data with a possible statistical significance. In this thesis, farming societies are studied through polished stone axes and hunter-gatherer societies through lithic flakes. Therefore, the main pillar of this thesis will be the development of methods to determine the handedness of the polisher of a stone axe, and of the knapper of a lithic flake.

In Table 1.1, the columns represent the type of society according to the *Homo* species forming it, and the rows represent whether the society is industrialised or not. In this way, three different types of society have been represented. In Box A, a modern Western population, which in the table would be in the column representing societies formed by *Homo*

*sapiens* and the row representing industrialised societies. In Box B, a Neolithic-Chalcolithic farming population, which occupies the position in the table for a non-industrialised society whose members belong to the species *Homo sapiens*, and Box C, a Middle Palaeolithic hunter-gatherer society, which occupies the position of a non-industrialised society formed by the species *Homo neanderthalensis*. Obviously, the box for an industrialised society formed by *Homo neanderthalensis* is empty. Arrows 1 and 2 represent the general approach of

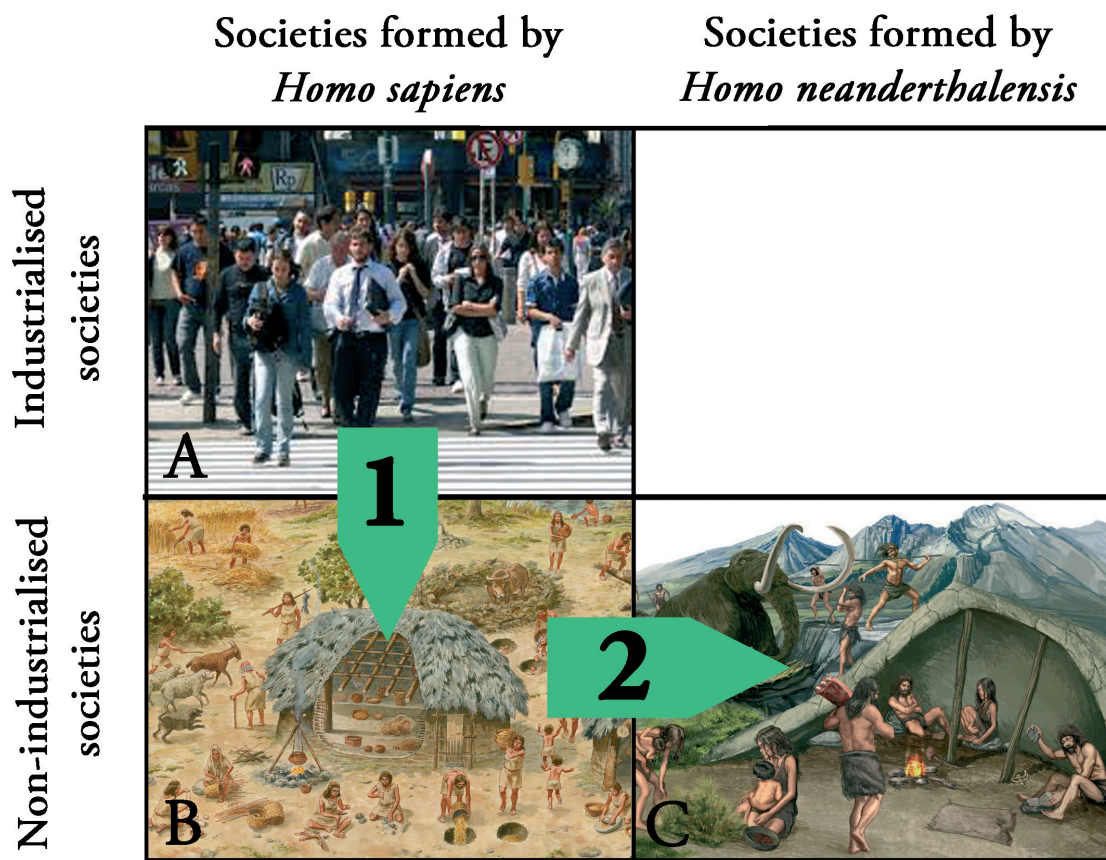

Tablae1.1 General approach to the development of the thesis. Pictures taken from: [www.dietasdeportivas.com](http://www.dietasdeportivas.com); [cimafermin.blogspot.com.es](http://cimafermin.blogspot.com.es); [1cruzdelsur.wordpress.com](http://1cruzdelsur.wordpress.com).

this thesis. In the first place, the approach is based on the study of literature of laterality in modern industrialised societies, in order to understand laterality levels in modern populations. This is reflected in Chapter 2 of the thesis. Later a method has been developed to establish the population-level laterality in farming societies and in this way understand how the cultural factor and level of industrialisation affects this phenomenon. It is complemented by a study of the literature on modern non-industrialised societies. Finally, once the influence of cultural factors has been determined, a method has been developed, described in Chapter 3, to establish the population-level laterality in Middle Palaeolithic populations formed by *Homo neanderthalensis*. In this way, the origin and evolution of the phenomenon of laterality in our own evolutionary line may be comprehended.

The research for this thesis has mainly been carried out in the Department of Geography, Prehistory and Archaeology at the University of the Basque Country, where the research needed to plan the work, perform the archaeological experimentation and write up the thesis has been done. In addition, some research has been done abroad. First, during a two months' stay at the University of Liverpool where an experimental archaeology programme and study of the literature was carried out under the supervision of Dr Natalie Uomini. In a later month's stay at the National Prehistory Museum at Les Eyzies-du-Tayac, the archaeological materials from the sites of Le Moustier and Vaufray were studied by applying the method developed for this thesis, under the supervision of Dr Alain Turq. Archaeological materials from Biscay, Álava and Navarre, and from the site of Axlor, were studied in the Museo Bibat in Álava and the Arkeologi Museoa de Bizkaia, respectively.

The study of laterality provides very valuable information in itself. Knowing whether there were left-handed and right-handed individuals in those societies can help us to understand how they might organise the groups, for hunting for example, or whether left-handedness was seen as the attribute of a shaman. Additionally, knowing population-level laterality can contribute data about other aspects. Brain functions are asymmetric within the brain (Bisazza et al., 1998) and laterality is one of the clearest etological manifestations of the presence of these asymmetries. Laterality is also clearly related to language, albeit in



a complex way (Knecht et al., 200a). Indeed, the brain functions of language were precisely some of the first brain asymmetries to be detected (Broca, 1861; Wernicke, 1874). The brain areas responsible for language are mostly found in the left hemisphere. However, for a small part of the population they are in the right hemisphere. This proportion of the population is not divided equally among left-handed and right-handed individuals; only 4% of right-handed people possess language in the right hemisphere, whereas for 27% of left-handed people it is in the right hemisphere (Knecht et al., 2000b). If we were able to establish the linguistic capabilities of our ancestors, we would be nearer understanding the origin of the human mind (Martínez and Arsuaga, 2009). In this respect, the study of laterality can provide information, through the analysis of archaeological remains, for researching language in our ancestors.



**Capítulo 2:**

**Antecedentes y  
estado de la  
cuestión**



## **2.1 Definición de lateralidad**

La lateralidad<sup>1</sup> es una cualidad que presentan algunas especies y que consiste en asignar roles diferentes a cada lado del cuerpo en el momento de realizar una tarea determinada, otorgando a uno de ellos mayor dominancia (Guiard, 1987). Podemos definirla como “La preferencia de cada individuo para usar una mano para tareas unimanuales y/o la habilidad para realizar tareas de manera más eficiente con una de las manos” (Corey et al., 2001). Recientemente, se ha demostrado que las asimetrías en el cerebro y en el comportamiento, la lateralidad, están extendidas a lo largo del subfilum de los vertebrados e incluso presente en algunas especies de invertebrados (Rogers, 2009; Rogers et al., 2013). Según Andrew y Rogers (2002) y MacNeilage, Rogers y Vallortigara (2009), la especialización de cada hemisferio en el cerebro humano estaba ya presente en los primeros vertebrados. Estos autores proponen que el hemisferio derecho toma el control en situaciones de peligro, cuando el animal necesita una reacción rápida y el hemisferio izquierdo toma el control en el comportamiento automotivado.

En el caso de nuestra especie se manifiesta de manera contundente en las extremidades superiores, en menor medida en las inferiores y de manera más modesta en ojos y oídos (Annett, 2002, 1970; Porac and Coren, 1981). Esta preferencia se ve aumentada cuando la tarea implica el uso de alguna herramienta y es más marcada en tareas complejas (Healey et al., 1986; Hinckley et al., 1997; Marchant et al., 1995; Provins, 1997a; Steenhuis and Bryden, 1989). Comúnmente hablamos de individuos zurdos y diestros dependiendo de la extremidad superior a la que asignan el rol dominante (Marchant et al. 1995), y establecemos ratios zurdo/diestro para las diferentes poblaciones. La lateralidad es hereditaria (Annett, 1973; Armour et al., 2014; Brandler et al., 2013; Levy and Nagylaki, 1972; McManus, 1991; McManus et al., 2013). Sin embargo, está fuertemente influenciada por factores am-

---

1 En castellano se utiliza el término “lateralidad” para referirse al concepto que los anglosajones denominan “laterality” pero también se extiende al concepto conocido como “handedness”. En inglés, “handedness” se refiere exclusivamente a lo que en castellano se denomina “lateralidad manual” o “dominancia manual”, mientras que “laterality” hace referencia a las asimetrías en general, y las cerebrales en concreto.

bientales y culturales, como por ejemplo, el estatus socio-económico (Annett and Kilshaw, 1983; Faurie and Raymond, 2013; Leiber and Axelrod, 1981; Perelle and Ehrman, 1994), el origen geográfico (Bryden et al., 1993; Holder and Kateeba, 2004; Marchant et al., 1995; McManus, 2009; Porac and Coren, 1981; Raymond and Pontier, 2004), o el nivel de occidentalización del individuo (Faurie et al., 2005; Marchant et al., 1995). Entre los primates actuales, el más lateralizado, con una asimetría cerebral mayor, es el *Homo sapiens*, con un ratio 1:9 en sociedades occidentales (Cashmore et al., 2008; Hardyck et al., 1975; Hopkins, 2013; Marchant and McGrew, 2013; McManus, 2009; McManus et al., 2013; Perelle and Ehrman, 1994), muy de lejos le sigue el chimpancé (*Pan troglodytes* y *Pan paniscus*), con un ratio de 1:1,72 (Hopkins et al., 2011). Esto sugiere que, durante la evolución de nuestros ancestros, su dominancia manual se volvía más fuerte a medida que tenían que resolver tareas de búsqueda de comida más elaboradas (MacNeilage et al., 2009).

Es importante definir y diferenciar dos conceptos muy utilizados en el ámbito de los estudios de dominancia manual: la preferencia individual por el uso de una mano y la lateralidad manual poblacional. Por una parte, se considera preferencia individual por el uso de una mano para realizar una tarea concreta, a que un individuo sienta una preferencia en usar una de las dos manos para realizar una tarea unimanual concreta. Por otro lado, la lateralidad poblacional consiste en que la mayoría de los individuos de en una población sientan preferencia por usar la misma mano para realizar una tarea unimanual concreta. De esta manera, podemos encontrarnos, por ejemplo, con poblaciones en las que el ratio de zurdos y diestros es de 50:50, pero cuyos miembros tienen una lateralización individual fuerte, es decir, que para una tarea concreta, cada uno de ellos la realiza preferentemente con una de las dos manos.

## **2.2 Bases fisiológicas de la lateralidad**

La lateralidad, o la dominancia manual, como comentaremos en este apartado, está estrechamente relacionada con la fisiología del cerebro. Comprender el funcionamiento de la lateralidad nos aporta información sobre la organización de nuestro cerebro, y conocer

las estructuras cerebrales que están relacionadas con la lateralidad nos ayuda a comprender cuándo surgieron y bajo qué contexto evolutivo se desarrollaron.

### 2.2.1 Estructura general del encefalo

El encéfalo está formado por el cerebro, el cerebelo, que se encuentra bajo él, el tálamo, el hipotálamo, los colículos, el puente y el bulbo raquídeo (Figure 2.1). El cerebro, a su vez, está compuesto por la corteza, el hipocampo, los ganglios basales y el bulbo olfatorio. En el cerebro podemos diferenciar dos tipos de materia, una conocida como materia blanca,



Figura 2.1 Localización de los elementos principales del encéfalo.

que se encuentra en la parte interna del cerebro y consiste en fibras nerviosas, y otra conocida como materia gris, compuesta por cuerpos celulares y que constituyen un manto de tejido nervioso que cubre la superficie del resto del cerebro. A este manto lo llamamos corteza cerebral. En términos filogenéticos, es la parte del cerebro más moderna, y la proporción de corteza frente al tejido sub-cortical ha ido aumentando con el tiempo en nuestra evolución, llegando incluso a provocar que la corteza, en vez de acomodarse al cráneo, tenga que plegarse sobre sí misma, formando lo que se conoce como circunvoluciones cerebrales. En el caso de los primates, y especialmente en el ser humano, la corteza está muy desarrollada y supone, con diferencia, la parte más extensa del cerebro. Este patrón de plegamiento varía de unas personas a otras pero existen unas circunvoluciones y fisuras principales que son en términos generales, comunes.

La corteza cerebral está dividida en dos mitades, conocidas como hemisferios cerebrales, separados por la cisura interhemisférica, y conectados entre sí por el cuerpo calloso. Como

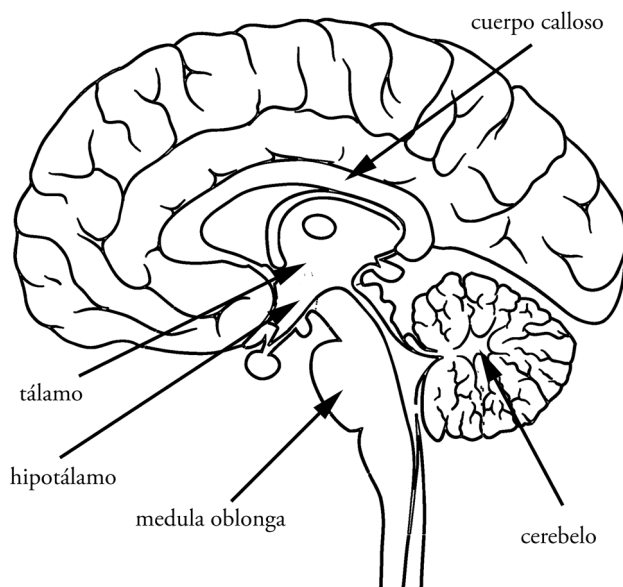

Figura 2.2 Representación de los lóbulos cerebrales de un hemisferio.

norma general cada hemisferio se ocupa principalmente del lado opuesto del cuerpo. A pesar de que el cerebro es bilateral, hay numerosas conexiones entre ambos lados y normalmente ambos hemisferios se comunican entre sí, mediante una estructura denominada “cuerpo caloso”, para evitar que cada lado del cuerpo actúe de manera independiente. La corteza cerebral a su vez, puede ser dividida en diferentes regiones o lóbulos. La división más simple consiste en cuatro partes: lóbulo frontal, lóbulo parietal, lóbulo temporal y lóbulo occipital (Figura 2.2). Los lóbulos frontales de ambos hemisferios no se encuentran alineados, y uno de los dos se extiende más el otro. Lo mismo ocurre con los lóbulos occipitales derecho e izquierdo y a estas protuberancias se las conoce como petalias (Figura 2.3).

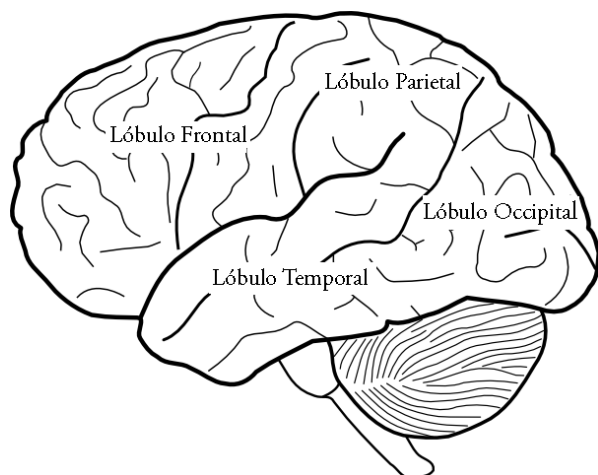

Figura 2.3 Representación de las protuberancias, producidas por la falta de alineación entre en los hemisferios cerebrales, conocidas como petalias.

El cerebelo, que es la parte posterior del encéfalo, también ha sufrido un aumento paulatino de tamaño durante la evolución de nuestro género (Herculano-Houzel, 2012). Aunque solo cuenta con el 10% del tamaño total del encéfalo, el cerebelo humano cuenta con más neuronas que el resto del encéfalo (Glickstein, 2007). Este órgano ha sido tradicionalmente considerado como responsable de la ejecución de movimientos (Evarts and Thach, 1969; Flourens, 1824), pero recientemente se ha descubierto que cuenta con conexiones con la corteza (Buckner et al., 2011; Stoodley, 2012), lo que sugiere que está implicado en funciones cognitivas (S. Häberling y Corballis, 2015).



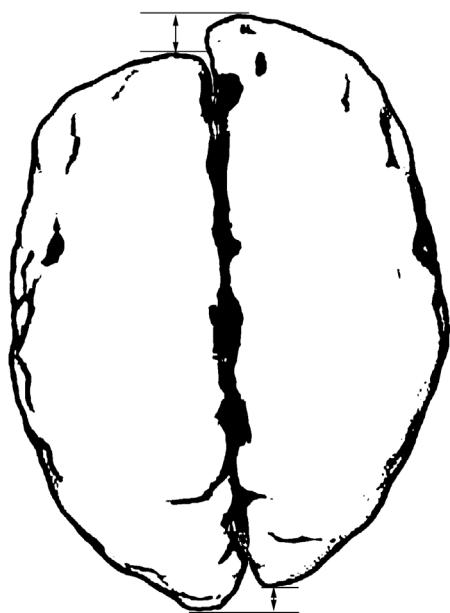

Figura 2.4 Representación de las áreas de Brodman del hemisferio cerebral izquierdo.

En otros órganos, como por ejemplo en los pulmones, podemos establecer, de manera relativamente directa, una correspondencia entre la anatomía y la función de cada estructura. Sin embargo, el cerebro es un órgano complejo cuya anatomía no refleja completamente su funcionamiento. Las áreas cerebrales encargadas del lenguaje, por ejemplo, no se pueden individualizar o delimitar y asociar con una estructura cerebral concreta. De hecho, pacientes diestros, que tienen las funciones cerebrales localizadas en el hemisferio izquierdo, y que han sufrido lesiones prolon-

gadas en dicho hemisferio, pueden experimentar un paso de las funciones del lenguaje y la dominancia manual al hemisferio derecho (Loring et al., 1990; Rasmussen y Milner, 1977; Vargha-Khadem et al., 1985; Woods et al., 1988), lo que demuestra la flexibilidad que presenta el cerebro en cuanto a la reubicación de funciones cerebrales. Por lo tanto, el estudio anatómico del cerebro, puede aportarnos numerosa información sobre el funcionamiento del mismo pero, a diferencia del de otros órganos, para comprenderlo en su totalidad debemos estudiarlo desde todas las perspectivas posibles. Además del estudio anatómico del cerebro, debemos aproximarnos a su comprensión desde una perspectiva psicológica, etológica y evolutiva. No podemos descartar la información que puede aportarnos el estudio de los restos arqueológicos sobre el cerebro y la cognición de quienes produjeron esos útiles, y concretamente sobre las asimetrías cerebrales, reflejadas en los útiles a través la dominancia manual, tema de estudio de esta tesis doctoral.

### 2.2.2 Asimetrías cerebrales

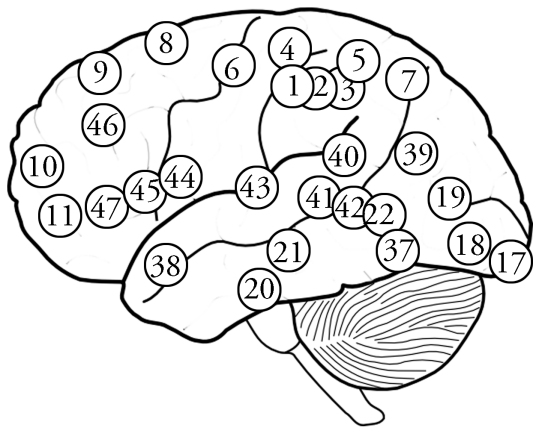
La corteza cerebral, presenta una naturaleza homogénea a simple vista, por lo que es difícil observar directamente estructuras diferenciadas. El primero en realizar un mapeo y establecer zonaciones en la corteza cerebral fue Brodman (1909). Utilizando una tintura

de Nissl pudo detectar diferentes zonas en la corteza en relación a su citoarquitectura<sup>2</sup>. Construyó, de esta manera, el primer mapa cerebral, conocido como “mapa de Brodman”, donde se representaban 51 áreas (Figura 2.4). Su clasificación era meramente morfológica, con base en las diferencias en el espesor de las capas corticales y en el tamaño y forma de las neuronas. Sin embargo, para poder localizar las diferentes funciones cerebrales y asociarlas con las diferentes áreas de Brodman, necesitamos métodos específicos de análisis, que nos permitan estudiar el cerebro en funcionamiento. El estudio de pacientes que han sufrido algún tipo de daño cerebral localizado, permitió el avance de estos estudios antes de que aparecieran técnicas de monitorización cerebral como la Imagen por Resonancia Magnética Funcional (fMRI).

Una de las primeras funciones asimétricas detectadas en el cerebro fue el lenguaje, después de examinar post mórtem los cerebros de sujetos con afasia. La afasia, descrita inicialmente por Wernicke (1874), es un trastorno del lenguaje, generado por una lesión cerebral, y que afecta a la capacidad de producir o comprender el lenguaje. Durante el siglo XIX, Broca y Wernicke detectaron que el lenguaje se veía más afectado en individuos que habían sufrido tumores o daños en el hemisferio izquierdo (Broca, 1861; Wernicke, 1874). Propusieron la idea, en aquel momento revolucionaria, de que ambos hemisferios no tenían las mismas propiedades. De esa manera, la producción del lenguaje y algunos aspectos del procesamiento de la sintaxis han sido localizados principalmente en el lóbulo frontal del hemisferio izquierdo (Área de Broca) mientras que la comprensión del lenguaje se ha localizado principalmente en el límite entre el lóbulo parietal y el lóbulo temporal del mismo hemisferio (Área de Wernicke) (Brinder, 2000; Dapretto y Bookheimer, 1999; Price, 2000; Toga y Thompson, 2003). El estudio de las asimetrías cerebrales y su relación con lateralidad manual ha sido también objeto de interés y debate (Annett, 1985; Beaton, 1997; Geschwind y Levitsky, 1968). A priori, parece lógico pensar que la dominancia manual esté relacionada con asimetrías en la corteza motora; sin embargo, esta zona de la corteza no presenta prácticamente asimetrías (Zilles et al., 1996). Sorprendentemente, la lateralidad manual

---

2 La citoarquitectura, en neurología es la forma en la que están organizadas los cuerpos de células (soma neuronal) que componen la corteza cerebral.

está relacionada de manera más intensa con las asimetrías funcionales de las estructuras del procesamiento del lenguaje (Witelson y Kigar, 1992). No obstante, la relación entre ambas no es estricta. En el caso de los diestros, las funciones relacionadas con el lenguaje se encuentran lateralizadas en el hemisferio izquierdo en un 97% de los casos, mientras que en el caso de los zurdos, un 70% presentan las funciones del lenguaje lateralizadas en ese mismo hemisferio izquierdo. Es decir, sólo el 3% de los diestros y el 30% de los zurdos presentan las funciones del lenguaje lateralizadas en el hemisferio derecho (Coren, 1992; Desmond et al., 1995; Rasmussen y Milner, 1977). Esto demuestra que la lateralidad manual y el lenguaje están relacionados, si bien de una manera compleja (Toga y Thompson, 2003).

Otra de las funciones lateralizadas en el cerebro es la de las habilidades espaciales (Deutsch et al., 1988). Según Kitterle (1991), existen dos tipos de habilidades espaciales. Por un lado habilidad de rotación mental, que consiste en identificar dos figuras idénticas, de forma irregular, rotadas en diferentes posiciones (Stafford Identical Blocks Test), y por otro lado, la habilidad de relaciones espaciales, que consiste en la capacidad de colocar mentalmente formas pequeñas dentro de una forma mayor (Minnesota Paper from Board). Como en el caso del lenguaje, las habilidades espaciales también han sido relacionadas con la lateralidad manual (Stochl, 2012). En promedio, los individuos diestros realizan mejor las tareas que implican habilidades espaciales, mientras que los zurdos lo hacen en las relacionadas con el lenguaje (Levy, 1969; McKeever, 1986; Miller, 1971).

La relación entre las asimetrías cerebrales y la lateralidad manual con las funciones visuales, han sido objeto de un extenso debate durante el siglo XX. Los estudios publicados sobre este tema son tan abundantes que, en 1975, Coren y Porac publicaron un recopilatorio bibliográfico de 235 artículos, que abarcaba desde el primer artículo sobre dominancia ocular (Porta, 1593) hasta los publicados en el año 1975. Posteriormente, Mapp et al. (2003) analizando la base de datos PsychINFO encontraron 340 artículos sobre esta temática entre 1975 y 2002, entre otras revisiones bibliográficas al respecto (Barbeito, 1979; Porac y Coren, 1976; Wade, 1998). El debate se centró en la determinación del concepto de dominancia ocular en cada individuo (concepto que puede referirse a la dominancia de agudeza visual,

a la dominancia direccional o a la predisposición a usar uno de los ojos cuando miramos por un antejo). En el caso de la determinación de la dominancia visual, los análisis factoriales ponen en duda el hecho de que exista una única dominancia ocular para cada persona (Mapp et al., 2003). Coren y Kaplan (1973) realizan 13 test a 54 individuos identificando tres factores independientes estadísticamente: (1) el ojo con mayor agudeza (2) el ojo predominante en competencia binocular (3) el ojo con dominancia direccional. Es decir, las diferentes dominancias oculares no tienen que coincidir necesariamente en el mismo ojo en un mismo sujeto, aunque suele ser lo común. De esta manera, numerosos estudios muestran que la dominancia medida mediante un solo criterio no está relacionada completamente con la dominancia medida mediante otro criterio (Clark y Warren, 1938; Coons y Mathias, 1928; Coren y Kaplan, 1973; Crovitz, 1961; Cuff, 1931; Downey, 1933; Fink, 1938; Friedlander, 1971; Gahagan, 1933; Gronwall y Sampson, 1971; Hildreth, 1949; Merrell, 1957; Mills, 1925; Money, 1972; Pointer, 2001; Porac y Coren, 1976; Porac et al., 1976; Schoen y Scofield, 1935; Snyder y Snyder, 1928; Walls, 1951; Washburn et al., 1934). Recientemente (Howard y Rogers, 2012; Howard, 2002), Howard define tres criterios para establecer la dominancia ocular:

*«1. El ojo con mejor agudeza visual, sensibilidad al contraste u otra medida del funcionamiento visual (...)*

*2. El ojo utilizado para la observación de un anillo mantenido en ambas manos a la longitud del brazo con los dos ojos abiertos.*

*3. El ojo en el que un estímulo rivalizante es con mayor frecuencia dominante »*

(Howard y Rogers, 2012, p. 80; Howard, 2002, p. 295)

Sin embargo, diferentes autores han realizado otros estudios posteriores para intentar determinar una única dominancia ocular mediante el uso de fMRI (Menon et al., 1997; Rombouts et al., 1996). En estos estudios detectaron que para individuos con dominancia ocular diestra, en respuesta a la estimulación monocular del ojo derecho, se activaba una mayor parte de la corteza visual primaria que en el caso de la estimulación monocular del

ojo izquierdo. Sin embargo, el efecto contrario no fue observado en individuos con dominancia ocular zurda. Según Mapp et al. (2003), lo que realmente estaban midiendo era la dominancia ocular direccional, ya que para determinar el ojo dominante utilizaron el test de Porta.

En lo referente a la relación entre la lateralidad ocular, la lateralidad manual y las asimetrías cerebrales, Mapp et al. (2003) creen que dicha relación, propuesta por otros autores, se basa en la premisa de que cualquier tipo de dominancia (ocular, manual,...) es debida a una única causa: la especialización hemisférica (Mapp et al., 2003). Sin embargo, según Mapp et al. (2003), no parece que, atendiendo a las diferencias entre las conexiones entre las extremidades y el cerebro y las conexiones entre los ojos y el cerebro, la especialización cerebral responsable de ambas dominancias sea la misma (Mapp et al., 2003). Las extremidades de cada lado se comunican única y exclusivamente con uno de los hemisferios (y a través del cuerpo caloso, con el otro), mientras que los ojos se comunican directamente con ambos hemisferios, y el movimiento de los músculos oculares emerge de ambos hemisferios, dependiendo de hacia dónde se desee mover los ojos (Mapp et al., 2003). Por lo tanto, según Mapp et al. (2003), el cerebro está lateralizado para las extremidades pero no para los ojos (Annett, 1999; Clark y Warren, 1938; p.e. Clark, 1957; Coren y Kaplan, 1973; Gronwall y Sampson, 1971; McManus et al., 1999; Merrell, 1957; Papousek y Schulter, 1999; Pointer, 2001; Porac y Coren, 1975; Snyder y Snyder, 1928; White, 1969).

Por otra parte, el estudio de pacientes con el cuerpo caloso dañado ha supuesto un avance en el conocimiento de las asimetrías cerebrales. Estos daños provocan la deficiencia en la comunicación entre los dos hemisferios cerebrales, desarrollando patologías como el síndrome de desconexión interhemisférica (Ventura, 2003). El estudio de estas patologías ha permitido conocer la relación entre los dos hemisferios y constatar la diferente funcionalidad de cada uno de ellos y su reorganización asimétrica y ha supuesto un gran avance para la comprensión del funcionamiento cerebral, ya que la destrucción del cuerpo caloso no supone el daño en la corteza y representa un modelo de estudio en el que los hemisferios se mantienen intactos (Ventura, 2003). La desconexión hemisférica fue detectada por primera

vez por Wernicke (Wernicke, 1874) y, más adelante, estudiada en relación a la patología del cuerpo caloso por Déjerine (Dejerine, 1892). Posteriormente, a mediados del siglo XX, y con el objetivo de paliar los efectos de la epilepsia, se comenzó a poner en marcha un tratamiento quirúrgico que consistía en seccionar el cuerpo caloso, evitando de esta manera la comunicación entre los hemisferios (Van Wagenen y Herren, 1940). En un ataque epiléptico, la convulsión se produce en una zona localizada de la corteza cerebral y, a partir de ella, se propaga a otras áreas. El objetivo de esta operación consistía en que el ataque quedara restringido a uno de los dos hemisferios únicamente, y que de esta manera el paciente pudiera controlar uno de los dos lados de su cuerpo. Los pacientes fueron estudiados por Akelais, y no se encontraron evidencias de que el tratamiento hubiera provocado discapacidades en las funciones psicológicas (Akelaitis, 1945, 1944, 1943, 1942, 1941; Akelaitis et al., 1942). Esto provocó dudas en la comunidad científica sobre la función de esta estructura. Sin embargo, más adelante, en la década de los 50 y 60, los experimentos de Myers y Sperry, llevados a cabo con gatos y monos, demostraron que esta estructura cumplía inequívocamente la función de comunicar a un hemisferio con el otro (Myers and Sperry, 1953). Los animales que habían sido operados, a priori, resultaban indistinguibles de los que no lo habían sido, en cuanto a su comportamiento y en condiciones de adiestramiento. Sin embargo, bajo procedimientos especiales de adiestramiento, existían grandes diferencias. Demostraron que si cada hemisferio recibe información sensorial por separado, cada uno presenta procesos perceptuales, de aprendizaje y de memoria separados (Myers y Sperry, 1953; Myers, 1965, 1962, 1960; Sperry, 1958; Sperry et al., 1956; Stamm y Sperry, 1957). Más adelante se estudiaron los humanos enfermos de epilepsia intratable, a los cuales se les había seccionado el cuerpo caloso, con resultados similares (Sperry, 1974). También se realizaron experimentos mediante taquistoscopios<sup>3</sup> en individuos con el cuerpo caloso seccionado, que mostraron que cada hemisferio es capaz de percibir y responder independientemente a los estímulos en su propio campo de visión (Gazzaniga et al., 1965). Este procedimiento consiste en, como aclara Beaton (1985), pedir al sujeto estudiado que indique, señalando o mediante otra respuesta, que ha entendido lo que le están mostrando. Mediante este método, se observó que

---

3 El taquistoscopio es un aparato que permite presentar una serie de estímulos luminosos a un individuo, por un breve lapso de tiempo, para estudiar la percepción visual.

habitualmente, la integración interhemisférica de patrones o de colores no se produce, pese a que cada hemisferio tiene la capacidad de percibir y recordar estímulos no verbales y de realizar combinaciones cruzadas (Beaton, 1985). Estas pruebas que consisten en estimular únicamente uno de los hemisferios puede realizarse, además de con pacientes con desconexión interhemisférica, con sujetos sanos. A partir de estos experimentos se comenzaron a estudiar las asimetrías cerebrales en profundidad y a comprender cómo se comunican ambos hemisferios.

La aparición de la Imagen por Resonancia Magnética Funcional (fMRI) permitió monitorizar los cerebros de cientos de individuos mientras realizaban tareas específicas obteniendo de esta manera un mapa detallado a tiempo real de la actividad cerebral. Desde hace tiempo que se conocían algunas diferencias anatómicas entre los dos hemisferios, como por ejemplo las petalias (Eberstaller, 1884). Esta técnica (fMRI) ha permitido descubrir diferencias funcionales entre los hemisferios, y numerosos estudios se han centrado en el lóbulo temporal, relacionado con el lenguaje y la lateralidad (Toga y Thompson, 2003), y ampliar los conocimientos sobre las diferencias que ya se conocían. Por ejemplo, mediante esta técnica, descubrieron que las petalias occipitales del hemisferio izquierdo y las frontales del hemisferio derecho son más grandes en diestros (Kertesz et al., 1986; LeMay y Kido, 1978). Además, han podido detectar más asimetrías cerebrales anatómicas, como la asimetría en la corteza perisilviana, asimetrías en los patrones de los sulcus cerebrales (que son las hendiduras que separan las circunvoluciones cerebrales), asimetrías en el surco lateral del cerebro (fisura silviana<sup>4</sup>), que suele ser más grande en el hemisferio izquierdo, o diferencias en la distribución de la materia blanca y la materia gris (Toga y Thompson, 2003).

Por lo tanto, como hemos comentado anteriormente, numerosos estudios demuestran que algunas asimetrías anatómicas cerebrales están relacionadas con la lateralidad manual (Kertesz et al., 1986; LeMay y Kido, 1978) y que de la misma manera, funciones asimétricas en nuestro cerebro, como por ejemplo el lenguaje o las habilidades espaciales, guardan una

---

4 El surco lateral del cerebro, o fisura de Silvio, es una hendidura que recorre transversalmente la corteza cerebral desde su base a través de ambos hemisferios.



relación directa pero compleja con la dominancia manual.

### **2.3 Lateralidad y dominancia manual en los animales no primates**

En el reino animal las asimetrías cerebrales y la lateralidad manual aparecen de manera extendida y variable. En el medio acuático, los animales sésiles<sup>5</sup> generalmente muestran simetría radial, y los planctónicos<sup>6</sup> simetría cónica, debido probablemente a que, en su medio de vida, es igual de probable que un depredador se acerque desde una dirección u otra (Gardner, 2005). Los animales nectónicos<sup>7</sup>, por el contrario, han desarrollado evolutivamente una diferencia entre parte anterior y posterior, y de la misma manera, los animales terrestres, debido a que caminan sobre una superficie, han desarrollado diferencias entre parte superior e inferior (Gardner, 2005). A pesar de ello, el medio acuático, terrestre o aéreo no posee de por sí ninguna peculiaridad que propicie evolutivamente las asimetrías, y por eso, en general, los peces, reptiles, pájaros y mamíferos mantienen esa simetría bilateral anatómica invariable (Stochl, 2012). Así todo, la asimetría bilateral existe, tanto a nivel anatómico como cognitivo, y está relacionada, en origen, con la aparición de estructuras helicoidales aisladas, presentes en formas de vida más sencillas como las bacterias y también en espermatozoides (Hinkovska et al., 1986; Veres, 1968). Se han detectado asimetrías a lo largo de todo el subfilum de los vertebrados e incluso en algunas especies de invertebrados (MacNeilage et al., 2009; Rogers et al., 2013).

En el caso de los peces, se han observado asimetrías anatómicas en las vísceras de algunas especies (Barth et al., 2005; Chen et al., 2001), y diferencias en la especialización hemisférica, como el caso del pez cebra, entre otros (Bisazza et al., 2007; Dadda y Bisazza, 2006; Halpern et al., 2003). Un ejemplo claro de asimetría en peces lo constituyen los peces planos, que en el momento de nacer poseen los dos ojos distribuidos simétricamente, uno en cada lado del animal, y a medida que crecen, uno de los ojos cambia de posición hasta colocarse

---

5 Se conocen como organismos sésiles aquellos que viven fijados al sustrato.

6 Se conocen como organismos planctónicos aquellos que viven suspendidos en el agua.

7 Se conocen como organismos nectónicos aquellos que nadan activamente en el agua.



en la mismo lado que el otro (Friedman, 2008; Gardner, 2005). Otro ejemplo de asimetría bilateral anatómica es el del *Anableps anableps*. Este pez posee los órganos sexuales ubicados únicamente en un lado del cuerpo, de esta manera los individuos con la misma “lateralidad sexual” no pueden reproducirse entre sí, lo que provoca que el ratio entre individuos de una lateralidad y otra este equilibrado y sea de 1/1 (Gardner, 2005). Existen también casos de asimetría bilateral en otros grupos de animales, como por ejemplo en algunos cangrejos, en los que los machos presentan diferentes tamaños en sus pinzas. En la mayoría de los casos el ratio está equilibrado y hay 50% de individuos en los que la pinza dominante es la izquierda y 50% en los que lo es la dominante, sin embargo, en el caso de *Uca vocans vomeris*, los que poseen dominancia de la pinza izquierda solo suponen un 1,4% (Backwell et al., 2007). Asimetrías anatómicas similares se han observado en algunas especies de sapos (Bisazza et al., 1997), así como en las alas de algunas moscas (Klingenberg et al., 1998).

En cuanto al comportamiento, por lo general, peces, reptiles y sapos tienden a golpear a sus presas en su lado derecho, guiados por su ojo derecho (MacNeilage et al., 2009). Se han realizado experimentos con sapos, en los que, se coloca una mosca, a modo de presa, en una pletina giratoria y se hace pasar por el campo de visión del animal girando la pletina en sentido dextrógiro y levógiro. Cuando se gira en sentido dextrógiro la presa pasa de estar en el campo de visión del ojo izquierdo del sapo al derecho, y éste no la da caza, en la mayoría de los casos, hasta que no pasa al campo de visión de su ojo derecho. En el caso contrario, cuando se gira la pletina en sentido levógiro, el sapo ataca en menos ocasiones y cuando lo hace, actúa por igual, tanto en el campo visual del ojo derecho como en el del izquierdo (MacNeilage et al., 2009).

Por otro lado, las aves han sido muy utilizadas en experimentos relacionados con la lateralidad y las asimetrías cerebrales, debido a que carecen de cuerpo calloso, y por ello, la comunicación interhemisférica está muy limitada (Bradshaw y Rogers, 1993). Además, prácticamente la totalidad del nervio óptico cruza al otro hemisferio en el quiasma óptico, a diferencia de lo que ocurre en humanos y primates, lo cual ha propiciado que se realicen numerosos estudios sobre las asimetrías de las funciones visuales (Cowan et al., 1961). La

mayor parte de las aves poseen un control independiente de cada ojo y los estímulos son inicialmente captados de manera monocular y procesados por el hemisferio del lado opuesto (Schaeffel et al., 1986). En estudios con pollos, se ha observado que los estímulos captados por el ojo izquierdo son interpretados en función de su posición espacial y los captados por el ojo derecho son interpretados según su categoría (Andrew, 1988). También se observa lateralización de la memoria entre los pollos (Horn y Johnson, 1989; Horn et al., 1973; Petrova y Markovskikh, 1986). Por otro lado, algunos autores han realizado estudios con loros, de los que al principio se creía que su dominancia de pie estaba relacionada con la lateralidad humana, refutándose después. En general, la mayoría de las aves poseen los órganos sexuales lateralizados. En las hembras sólo el ovario izquierdo es funcional y entre los machos, el testículo izquierdo es más grande. Los ovarios y testículos derechos servirían a modo de reserva, por si se daña el izquierdo (Calhim y Birkhead, 2009).

En cuanto al comportamiento de las aves, también se ha detectado que los pollos están lateralizados respecto al miedo, ataque y copulación, funciones dominadas por el hemisferio derecho (Rogers, 1982; Zappia y Rogers, 1983). Algunos autores han realizado experimentos practicando lesiones en el hemisferio izquierdo de pollos jóvenes, comprobando que los individuos afectados atacan y copulan con más frecuencia (Andrew, 1966).

Entre los mamíferos no primates también encontramos numerosos casos de asimetrías, tanto cerebrales como en el comportamiento. Por ejemplo, en las ratas, se ha detectado dominancia diestra en las patas (Guven et al., 2003; Pence, 2002), y asimetrías cerebrales, siendo el hemisferio derecho el más grande (Kolb et al., 1982). Según Kolb et al. (1982), también los gatos presentan el hemisferio derecho de mayor tamaño. Sin embargo, en cuanto a la dominancia de la pata de los gatos existen diferentes opiniones. Según Cole (1955) y Fabre-Thorpe et al. (1993), los gatos presentan una dominancia de la pata izquierda, al contrario que las ratas que, según Tan et al. (1990), la dominancia que presentan es diestra. Lorincz y Fabre-Thorpe (1994) sugieren que estas diferencias de dominancia son debidas a que los sujetos presentan mayor práctica con una de las extremidades. Los perros, que también presentan el hemisferio derecho de mayor tamaño (Tan y Caliskan, 1987), presentan

dominancia de una de las patas (Aydinlioglu et al., 2000), que se ve también influenciada por la práctica (Poyser et al., 2006), como en el caso de los gatos. Otro de los mamíferos que presenta el hemisferio derecho más grande según Kolb et al. (1982) es el conejo. El primer ojo que abren estos mamíferos durante su desarrollo es el derecho, por lo que este ojo se desarrolla más que el izquierdo (Narang, 1977).

Entre los marsupiales también se han documentado asimetrías, tales como las del australiano posúm de cola de cepillo o el koala, que presentan dominancia de una de las patas (Megirian et al., 1977; Smith, 1979).

Entre los mamíferos marinos, las ballenas jorobadas representan un excelente ejemplo de lateralización relacionada con la alimentación (MacNeilage et al., 2009). En un estudio realizado por Phillip J. Clapham (2004), de los 75 ejemplares de ballenas estudiadas, 60 presentaban abrasión solo en el lado derecho de las barbas, mientras que tan sólo 15 lo presentaban en el lado izquierdo. Además, tanto los cetáceos dentados en general, presentan asimetrías craneales y mayor desarrollo del hemisferio derecho (Bradshaw y Rogers, 1993). El narval, por ejemplo, presenta un desarrollo excepcional solo en uno de los colmillos (Gardner, 2005) y es conocido que los delfines pueden dormir solo uno de los hemisferios, manteniendo uno de los ojos abiertos (Mukhametov, 1987).

En cuanto al comportamiento lateralizado, se han observado asimetrías en la forma de nadar en delfines, dependiendo de si están en el hemisferio norte o en el sur (Stafne, 2004), que podría estar relacionado, según Stafne (2004), con el efecto Coriolis (Coriolis, 1835). También se ha detectado algo similar en el vuelo de mamíferos voladores, como los murciélagos cuando salen de las cuevas, que realizan el vuelo en espirales dextrógiras (Krutch, 1952).

## **2.4 Lateralidad y dominancia manual en primates no humanos**

El estudio de la lateralidad en los primates no humanos tiene especial interés porque nos

puede ayudar a comprender la evolución de este fenómeno en nuestro propio género y a construir modelos de evolución de la lateralidad humana (Cashmore et al., 2008). Se han observado asimetrías cerebrales en grandes simios y otros primates de menor tamaño como el macaco rhesus (*Macaca mulatta*), siendo mayores las medidas tomadas en el hemisferio derecho (Falk et al., 1988) y observando variaciones de este fenómeno en función del sexo y la edad (Helmkamp y Falk, 1990). Algunos primates también presentan asimetrías cognitivas (Bradshaw y Rogers, 1993). En macacos, por ejemplo, las vocalizaciones parecen estar más ligadas al hemisferio izquierdo (Petersen et al., 1978).

En cuanto a la dominancia manual en primates no humanos, existe un gran debate. La lateralidad manual, parece ser más débil y variable que la de los primates humanos. Para el caso de los estrepsirinos, se han realizado estudios en gálagos menores (*Galaga senegalensis*) mediante tareas que implican la búsqueda de comida, detectando una fuerte preferencia manual zurda (Sanford et al., 1984). Para el caso de los haplorinos, Masataka (1990) estudió 31 monos capuchinos y concluyó que 25 mostraban preferencia por la mano derecha y cuatro por la izquierda. También se ha observado la preferencia de la mano izquierda para los macacos jóvenes y adultos, y el uso a nivel grupal de la mano derecha en macacos más mayores (Westergaard y Lussier, 1999). Se han realizado estudios en titíes (*Callithrix jacchus*) mediante tareas como la búsqueda de comida, sostener comida, golpear o empezar a escalar y andar (Box, 1977; Matoba et al., 1991; Rothe, 1973; Stellar, 1960). En el estudio de Matoba et al. (1991), el 43% presentan dominancia de la mano izquierda, el 24% de la derecha y el 33% son ambidiestros (Matoba et al., 1991), aunque en otros estudios se ha detectado preferencia por la mano derecha (Rothe, 1973; Stellar, 1960). También se han estudiado monos cebus detectando fuertes preferencias manuales individuales (Kounin, 1938). Ettlínger y su equipo (Ettlínger, 1961; Ettlínger y Moffett, 1964; Gautrin y Ettlínger, 1970; Milner, 1969) observaron preferencia por el uso de la mano izquierda en el caso de monos reshus (*Macaca mulatta*) para tareas de discriminación táctil. Sin embargo, Deuel y Dunlop (1980) observaron que 8 de 15 monos reshus presentaban preferencia por la mano derecha. También se ha observado preferencia de la mano izquierda para el caso de macacos japoneses (*Macaca fuscata*) en tareas como atrapar comida lanzada por los investigadores (Itani, 1957;

Itani et al., 1963; Tokuda, 1969). Zhao et al. (2016), han detectado dominancia manual para macacos de cola de cerdo norteño (*Macaca leonida*) en la realización de la popular tarea TUBE<sup>8</sup>, diseñada por Hopkins (1995), que consiste en ofrecer al sujeto un trozo de comida o “premio”, introducido en un estrecho tubo, de tal manera que para acceder a él, el individuo debe sostener el tubo con una mano e introducir un dedo de la otra mano para conseguir su objetivo. Según los autores, existe una alta preferencia individual, pero no han observado preferencia manual poblacional (Zhao et al., 2016). También se ha detectado lateralidad diestra para la manipulación de objetos en macacos rabón (*Macaca speciosa*) (Beck y Barton, 1972).

A pesar de que no son los únicos primates capaces de utilizar herramientas (Mangalam et al., 2016), el estudio de los simios antropomorfos, particularmente los gorilas, muestra que presentan capacidades de manipulación no muy diferentes de las nuestras (Byrne et al., 2001) y permite establecer comparaciones interesantes en lo referente al uso de herramientas (Goodall, 1964; Roffman et al., 2012), la locomoción bípeda (Videan y McGrew, 2002) o las habilidades comunicativas (Savage-Rumbaugh et al., 1986). En general, en primates en cautividad no se han observado niveles poblacionales de dominancia manual (Annett y Annett, 1991; Harrison y Nystrom, 2010, 2008; Hopkins et al., 2009), salvo para el caso de gestos (Hopkins et al., 2005) y tareas específicas en grandes simios (Hopkins y DeWaal, 1995; Hopkins, 1994; Hopkins et al., 2011, 1993). En cambio, sí se han observado diferencias individuales en bonobos (Harrison y Nystrom, 2008; Hopkins et al., 1993; Shafer, 1997) y en orangutanes en cautividad (O'Malley y McGrew, 2006; Rogers y Kaplan, 1996). En individuos salvajes se ha detectado una dominancia manual zurda para el caso de la alimentación (Lonsdorf y Hopkins, 2005). Se han observado preferencias individuales en condiciones salvajes en el caso de chimpancés comunes (Marchant y McGrew, 1996), gorilas (Parnell, 2001) y orangutanes (Peters y Rogers, 2008).

---

8 La tarea TUBE, conocida como “TUBE task”, es un método para determinar la dominancia manual en primates, diseñado por Hopkins (1995), que consiste en introducir un premio en el interior de un tubo con las dimensiones adecuadas para que el sujeto estudiado deba sujetar el tubo con una mano e introducir un único dedo en el interior si quiere obtener la recompensa. De esta manera, se puede determinar que mano es la dominante para cada individuo.

Finch (1941) estudió la lateralidad manual de 30 chimpancés (*Pan troglodytes*), para tareas unimanuales como recoger comida directamente tirando de una cuerda o desplazando una caja. Detectó una preferencia manual individual: 25 de los individuos realizaban el 80% de las tareas con una de las manos (once presentaban dominancia de la mano derecha y catorce de la izquierda). También, algunos autores, han observado preferencia por la mano derecha de las hembras gorila para agarrarse mientras sujetan con la izquierda a sus crías (Fischer et al., 1982). Algunos estudios han demostrado preferencia por la mano derecha en gorilas (Lehman, 1980; Olson et al., 1990), izquierda en gibones y distribución bimodal en orangutanes (Olson et al., 1990), mientras que otros parecen desestimar estas hipótesis (Byrne y Byrne, 1991; Fagot y Vauclair, 1988; Harrison y Nystrom, 2010; Parnell, 2001). En cuanto a la acción de búsqueda trípeda<sup>9</sup> de alimentos se ha observado que los grandes simios están muy levemente lateralizados (Cashmore et al., 2008). Muchos de los individuos no muestran preferencia, y los autores no han detectado lateralidad a nivel poblacional en el caso de los chimpancés (Colell et al., 1995; Finch, 1941; Hopkins y Pearson, 2000; Hopkins, 1993; Marchant y Steklis, 1986), bonobos (Hopkins y DeWaal, 1995; Hopkins et al., 1993; Vleeschouwer et al., 1995), gorilas (Fagot y Vauclair, 1988; Olson et al., 1990) y orangutanes (Heestand, 1986; Hopkins, 1993; Olson et al., 1990). En cuanto a la búsqueda bípeda, han observado una mayor preferencia por la mano derecha en comparación a la búsqueda trípeda (Cashmore et al., 2008) para el caso de chimpancés (Hopkins, 1993), bonobos (Hopkins et al., 1993), gorilas y orangutanes (Olson et al., 1990). En cuanto a la alimentación, atendiendo a la mano con la que se lleva la comida a la boca, se han observado preferencias individuales (Cashmore et al., 2008), para chimpancés salvajes (Marchant y McGrew, 1996), bonobos (Harrison y Nystrom, 2008; Hopkins et al., 1993; Shafer, 1997), gorilas salvajes (Parnell, 2001) y orangutanes (O'Malley y McGrew, 2006; Rogers y Kaplan, 1996). En cuanto a la preferencia manual para realizar tareas en las que una mano manipula el ítem mientras que la otra lo sujeta (Corp y Byrne, 2004; Guiard, 1987) los chimpancés salvajes han mostrado una fuerte lateralización individual para el procesamiento de frutos de Saba y limones, pero sin presentar tendencias poblacionales (Byrne y Corp,

---

<sup>9</sup> Hablamos de postura trípeda para la búsqueda de alimentos cuando el animal utiliza tres patas para la locomoción y una para recoger alimentos.

2003; Corp y Byrne, 2004). El estudio de la lateralidad en primates no humanos a partir de herramientas, se ha centrado en los chimpancés (Cashmore et al., 2008), observándose una fuerte lateralización para la “captura de termitas” (Lonsdorf y Hopkins, 2005; Marchant y McGrew, 1996; McGrew y Marchant, 1999, 1992; Nishida y Hiraiwa, 1982) detectándose en algunos casos preferencias manuales a nivel poblacional (Lonsdorf y Hopkins, 2005). En el caso de orangutanes y bonobos, también han detectado preferencias manuales en el uso de herramientas (Harrison y Nystrom, 2008; O’Malley y McGrew, 2006).

Hopkins et al (Hopkins et al., 2003) realizan un estudio en 31 gorilas en cautividad (*Gorilla gorilla*) y 19 orangutanes en cautividad (*Pongo Pygmaeus*) que compararon con los datos de más de 200 chimpancés (*Pan troglodytes*) del Yerkes National Primate Research Center (YNPRC). Para realizar el análisis de la dominancia manual utilizaron la tarea TUBE, realizada con un tubo de 15 centímetros de longitud y 2,5 de ancho y utilizando mantequilla de cacahuete como “premio”. Más adelante, Hopkins et al. (2011), estudiaron la preferencia manual de 777 grandes simios en acciones bimanuales coordinadas. Para ello analizaron cuatro especies diferentes de simios antropomorfos: *Pan troglodytes* (536 sujetos), *Gorilla gorilla* (76 sujetos), *Pongo pygmaeus* (47 sujetos) y *Pan paniscus* (118 sujetos). Como resultado, determinaron que el orangután presentaba un ratio zurdo/diestro de 0,38, el gorila de 3,28, el chimpancé común de 1,72 y el chimpancé pigmeo o bonobo 1,40, siempre inferior al observado en humanos: 9 (Hopkins et al., 2011). Según Hopkins et al. (2011) los chimpancés y gorilas adultos presentarían niveles poblacionales de dominancia manual diestra, los orangutanes niveles poblacionales de dominancia manual zurda y los bonobos estarían en el límite de una dominancia manual diestra poblacional.

## **2.5 Lateralidad y dominancia manual en humanos**

Hoy e día, no se conocen sociedades humanas actuales en las que la mayoría de sus miembros sean zurdos (Marchant y McGrew, 2013), ni tampoco sociedades en las que los zurdos estén ausentes (Annett, 2002). Sin embargo, el numero de zurdos y diestros varía de unas



poblaciones a otras. Por otro lado, en el caso de los humanos, existe una relación compleja entre la lateralidad manual y el lenguaje. La dominancia manual poblacional solo se manifiesta tan explícitamente en el ser humano, y esto puede ser debido a que está relacionada con otra característica única de nuestra especie: el habla (Steele y Uomini, 2005). Estas dos cuestiones hacen que el origen de la dominancia manual, su relación con el lenguaje, y su evolución a lo largo de nuestro género sean complejos de analizar, lo que ha suscitado un gran interés entre la comunidad científica.

### 2.5.1 Origen de la lateralidad

A pesar de que se sabe que nuestro hemisferio izquierdo y derecho difieren entre ellos desde el punto de vista anatómico y funcional, se conoce muy poco sobre los factores ambientales o genéticos que rigen las asimetrías del sistema nervioso central (Geschwind et al., 2002). En la actualidad, el 8% de los humanos son considerados zurdos y las primeras observaciones sugieren que existe un origen genético de la lateralidad manual. Sin embargo, los estudios en gemelos monocigóticos presentan ciertas discordancias (McManus, 1991) y sugieren que el origen y evolución de la lateralidad manual tuvo que ser más complejo.

#### 2.5.1.1 Origen genético de la lateralidad

Los primeros modelos genéticos formales de la lateralidad manual fueron propuestos por Ramaley (1913), quién remarcó lo que Jordan (1911) había publicado, concluyendo que la lateralidad manual zurda se heredaba como un carácter recesivo. Según la hipótesis de Ramaley, de dos progenitores zurdos, la descendencia debería ser zurda también, lo cual no ocurre necesariamente. Por lo tanto, este modelo no es capaz de explicar la realidad. Ramaley atribuía este error a que quizá uno de los progenitores fuera genéticamente diestro y su zurdera fuera adquirida. Posteriores trabajos intentaron solucionar estos desajustes apelando a las diferencias entre los sexos (Chamberlain, 1928), a una penetrancia<sup>10</sup> parcial en homo-

---

<sup>10</sup> La penetrancia genética es el número de individuos heterocigotos patológicos dividido por el número total de heterocigotos.



cigóticos recesivos (Rife, 1950; Trankell, 1955) o a una lateralidad cruzada en heterocigotos (Annett, 1964). Además, Levy y Nagylaki (1972) diseñaron otro modelo basándose en dos alelos, pero que, al igual que el modelo de Annett (1964), no es capaz de explicar los datos obtenidos en gemelos. Si cada genotipo está asociado específicamente con una dominancia manual diestra o zurda, la dominancia manual debería ser idéntica en gemelos monozigóticos que comparten el mismo genotipo (McManus y Bryden, 1991).

Posteriormente se han postulado dos modelos genéticos para la lateralidad manual, en los que los diestros heredan una tendencia direccional para la dominancia cerebral del lenguaje y la dominancia motora que predispone a los individuos a ser diestros y a presentar el lenguaje en el hemisferio izquierdo: la teoría genética conocida como “Right-shift theory” (Annett, 1985) y el modelo correctivo propuesto por McManus (1991).

El modelo “Right-shift” propuesto por Annett (Annett, 1985) se basa en la distribución unimodal de las diferencias en habilidad de cada mano, obtenidas midiendo el tiempo requerido para hacer una tarea concreta con cada una de las manos (Annett, 1972). Se comparó, en diferentes individuos, el tiempo que tardaban en hacer una tarea determinada con una mano y con la otra, y la diferencia entre ambos tiempos, adquiere una distribución normal, en forma de campana de Gauss, ligeramente desviada hacia la derecha. Es decir, la mayor parte de la gente realiza la tarea más rápido con la derecha y la distribución global es en forma de campana. Esta teoría sugiere que el mayor determinante de la lateralidad manual en el ser humano es el azar, durante el crecimiento del individuo, posiblemente por accidentes aleatorios en la construcción de los dos lados del cuerpo, con una tendencia a la dominancia manual diestra producida por un único gen ( $rs+$ ) que otorga cierta ventaja al hemisferio izquierdo para el desarrollo del lenguaje (Annett, 1986). Por lo tanto, se trata de un modelo probabilista, y no determinista. En ausencia de este gen, según Annett (1986), la lateralidad depende exclusivamente del azar. Esta teoría predice la lateralidad manual en familias. La interpretación de los datos en gemelos llevan a la hipótesis de que la expresión del gen  $rs+$  en gemelos es más reducida que en hijos únicos y predice la distribución en gemelos monocigóticos y dicigóticos.

El modelo original de McManus (1985) propuso la existencia de dos alelos: D (Dextro) y C (Azar). De tal manera que el genotipo DD produciría dominancia manual diestra en toda la descendencia, y el genotipo CC provocaría lo que se conoce en biología como asimetría fluctuante, siendo el 50% de la descendencia zurda y el otro 50%, diestra. En el caso de un genotipo DC, se produciría un 25% de descendencia zurda. Este modelo genético se puede extender a la dominancia cerebral asumiendo que estos genes también controlan la dominancia de lenguaje (McManus, 1991). Posteriormente McManus y Bryden (McManus y Bryden, 1991) modificaron este modelo para ajustarlo con las diferencias observadas entre los sexos, incluyendo un nuevo locus<sup>11</sup> de modificación del cromosoma X con dos alelos: M y m.

Ambos modelos reflejan la biología de la asimetría y la fluctuación asimétrica (McManus, 1991), y sus diferencias residen en la concepción del fenotipo de la lateralidad manual (Annett, 1985; McManus, 1985). Los modelos más antiguos, en general, se caracterizan por asociar un alelo para cada fenotipo, estos modelos más recientes, en cambio, son asimétricos en el sentido de que un alelo no produce el efecto especular del otro, los modelos son intrínsecamente asimétricos (McManus y Bryden, 1991).

#### 2.5.1.2 Origen evolutivo de la lateralidad

Una vez establecido que la lateralidad humana tiene una dimensión genética, que es hereditaria, varios autores han intentado explicar la escasa presencia de zurdos en todas las sociedades humanas, y comprender los procesos evolutivos que dan lugar a esa situación. Según Llaurens et al. (2009), debemos plantearnos dos preguntas si queremos comprender la evolución de la lateralidad manual en los humanos: ¿por qué es el uso de las manos asimétrico? (¿por qué los individuos muestran una preferencia por una de las manos para realizar la mayoría de las tareas?), y ¿por qué es el uso de las manos un polimorfo asimétrico? (¿por qué algunos individuos prefieren usar como dominante la mano izquierda y otros la derecha?). Desde mediados del siglo XX se han ideado diferentes modelos, bajo distintos marcos

---

11 Un locus es una posición fija de un gen dentro de un cromosoma.

evolutivos, dando lugar a hipótesis que tratan de dar respuesta a estas dos preguntas.

Una de esas hipótesis es la basada en la lucha. Según sus autores (Raymond et al., 1996), los problemas que pueda suponer ser zurdo son compensados cuando el individuo se ve envuelto en una lucha con un diestro, debido al factor sorpresa de efectuar el ataque de manera diferente a como lo hacen la mayor parte de los individuos, que son diestros. Debido a que esta ventaja depende de que el número de zurdos sea considerablemente menor que el de diestros se trataría de un caso de selección negativa según la frecuencia (Faurie et al., 2005; Raymond et al., 1996). Esta hipótesis también podría explicar la mayor presencia de zurdos entre hombres que entre mujeres, asumiendo que son los que históricamente han participado más en las luchas. Se ha intentado demostrar esta hipótesis aplicándola a deportes de lucha actuales, con éxito en algunos casos (Gursoy, 2009), en el que se analizaron 22 boxeadores de la “National Road Sport Men Boxing Club de Erzurum en Turquía, detectando que los zurdos tenían más éxito que los diestros. Sin embargo, entre los luchadores de la UFC, a pesar de que los zurdos se ven sobre representados (20,4%), no se ha detectado que tengan más probabilidades de ganar (Pollet et al., 2013). Este deporte, según los autores, se asemeja más a los contextos de lucha de poblaciones del pasado, ya que carece prácticamente de normas, a diferencia de otros deportes actuales, como el boxeo (Pollet et al., 2013).

Otra de las hipótesis que se han propuesto es la de Calvin (1983), en la que propone que, a partir de la observación de que, históricamente, las madres tienden a sujetar a sus bebés en el lado izquierdo, para que sus hijos escuchen mejor el latido de su corazón, dejando libre su mano derecha para realizar tareas. Según Calvin (1983), si el llevar a sus crías en el lado izquierdo fuera una consecuencia de la dominancia manual diestra, debería observarse también en los hombres cuando transportan a sus crías, sin embargo, según él, los varones presentan indiferencia a la hora de sostener a los bebés con uno u otro brazo. Por lo tanto, según Calvin, la preferencia de las madres por sostener a sus crías con el brazo izquierdo sería la causa, y no la consecuencia de la dominancia manual diestra, lo que supondría, según él, cierta ventaja a la hora de cazar (Calvin, 1983). Concretamente, Calvin (1983), relaciona la lateralidad con la tarea de lanzar. Otros autores han propuesto que el uso de herramientas

tuvo un papel importante en la evolución de la lateralidad manual (Frost, 1980; Kimura, 1979; Provins, 1997b), relacionando estas teorías con las de Calvin debido a que ambas tareas (el uso de herramientas y el lanzamiento de objetos) requieren niveles cognitivos altos (Cashmore et al., 2008).

Otra de estas hipótesis sugiere que la aparición de la lateralidad manual en los humanos está asociada con la emergencia del bipedalismo. Según algunos estudios (Falk, 1987; Sanford et al., 1984; Westergaard et al., 1998), el bipedalismo dejaría libres ambas manos y como consecuencia se podrían desarrollar y mejorar las habilidades cerebrales, para mantener el equilibrio en una posición menos estable que la cuadrúpeda. Indirectamente, el bipedalismo habría posibilitado la realización de tareas (como la confección de herramientas) que están relacionadas con la emergencia de la lateralidad manual (Bradshaw, 1991).

MacNeilage et al. (1987) desarrollaron la hipótesis “postural”, en la que proponen que la primera especialización fue hemisférica, y afectó a funciones manuales en prosimios<sup>12</sup>, relacionadas con la búsqueda de comida mediante la vista, acompañada de una adaptación estructural relacionada con la locomoción, a través de la cual evoluciona la mano prensil. Según MacNeilage, la preferencia por la mano izquierda está más marcada en animales como los gálagos y tarseros (ambos considerados prosimios), que son bípedos (arbóreos) y adquieren postura erguida para alimentándose de insectos, que no son fáciles de cazar. Esta asimetría parece haber evolucionado hace más de 50 millones de años (MacNeilage et al., 1987), y si es así, según MacNeilage, la especialización inicial se tuvo que producir en primer término para el uso de la información visual para la búsqueda de alimentos. Según MacNeilage, la preferencia por la mano derecha para tareas de manipulación no está presente en prosimios, que poseen muy pocas adaptaciones estructurales en la mano adaptadas a este propósito, y su comportamiento implica en muy pocas ocasiones este tipo de tareas (Bishop, 1964). El uso de la mano derecha evolucionaria, según MacNeilage, a partir de la

---

12 Los prosimios son un suborden de primates en el que se incluían antiguamente los Lemuriformes, Chiromyiformes, Lorisiformes y Tarsiiformes. Se trata de un grupo polifilético ya que engloba diferentes grupos que no presentan ninguna característica apomórfica que justifique incluirlos bajo un mismo taxón.

aparición del pulgar oponible y la habilidad de agarrar con precisión (Napier, 1962). Según esta teoría, la dominancia diestra y zurda observados en primates no humanos es la precursora de la especialización humana y se sugiere que la clave está en la exaptación<sup>13</sup> (preadaptación) postural del brazo-mano derecho que acompaña a la evolución de las preferencias por la mano izquierda para alcanzar comida (MacNeilage et al., 1987). La mano derecha serviría de soporte postural para tareas que implican alcanzar alimentos en prosimios (arborícolas), que presentan una dominancia manual zurda poblacional, y en primates superiores, con un modo de vida más terrestre, la mano derecha ya no es necesaria para otorgar un soporte postural y quedaba libre para especializarse en tareas de manipulación de objetos y coordinación bimanual (Scheumann et al., 2011).

Otra de las hipótesis propuestas es la conocida como la de dominancia dinámica. Sainburg y Kalakanis (2000) examinaron las diferencias entre las dos extremidades superiores y su coordinación en tareas que implican alcanzar objetos, demostrando la ventaja del brazo dominante. Estos autores realizaron una experimentación en la que fijan una carga excéntrica de un kilo sobre el eje del antebrazo del sujeto, comprobando que el brazo dominante se adapta mejor a los nuevos movimientos y que no debería haber diferencias entre el brazo dominante y el no dominante en adaptar el movimiento a las rotaciones visuomotoras, es decir, en sincronizar la información visual con el movimiento físico, que comprueban rotando 30° la imagen que el sujeto ve durante la tarea (Sainburg, 2002). Esta fue la base para desarrollar esta teoría, en la que proponen que existen mecanismos neuronales diferentes para el control del brazo dominante y para el control del brazo no dominante.

Otra de las teorías evolutivas para la emergencia de la lateralidad manual es la conocida como la teoría de la complejidad de la tarea, formulada por Fagot y Vauclair (1991). Según Fagot y Vauclair la lateralidad manual en terminos poblacionales es más probable que aparezca cuando las tareas son complejas. Según esta teoría, las tareas más complejas pueden aflorar una lateralidad más fuerte en primates no humanos (Cashmore et al., 2008).

---

13 La exaptación, conocida antiguamente como preadaptación, es una adaptación evolutiva que surge con una función determinada y que posteriormente cubre otra necesidad para la cual no había sido seleccionada.

### 2.5.2 Lenguaje, lateralidad y dominancia manual

Dax (1836) es el primero en asociar el lenguaje con las lesiones en el hemisferio izquierdo. Sin embargo, los trabajos pioneros más importantes son los realizados por Broca (1861). Su contribución fue la de identificar la tercera circunvolución frontal del hemisferio izquierdo como el centro para el lenguaje articulado (Broca, 1861). Broca descubrió, analizando postmortem el cerebro de un paciente que había sufrido disfasia<sup>14</sup>, que presentaba daños severos en esta área, ahora conocida como área de Broca. Posteriormente, Wernicke (1874), asoció los defectos en la comprensión del lenguaje con daños en la mitad posterior de la circunvolución temporal superior, conocida actualmente como área de Wernicke. El fascículo arqueado, que consiste en una ruta neuronal que conecta las áreas receptoras posteriores (lóbulo temporal) con las áreas premotoras y motoras, también tiene un papel importante en la producción del lenguaje (Bernal y Ardila, 2009). Se ha demostrado que daños en el área de Broca provocan defectos en la producción del lenguaje, que daños en el área de Wernicke provocan deficiencias en la comprensión y que daños en el fascículo arqueado provocan el síndrome de afasia de conducción<sup>15</sup> (Geschwind, 1974, 1970). Otras áreas, como el tálamo, también participan en la producción del lenguaje (Brown, 1975; Ojemann y Mateer, 1979). Jackson (Jackson, 1868) estudió pacientes zurdos afásicos<sup>16</sup> con lesiones en el hemisferio derecho y Bramwell (1899) detectó lo que se conoce como afasia cruzada<sup>17</sup>, que consiste en presentar la lesión en el mismo lado del cerebro de la mano dominante, y no en el opuesto, como es habitual. Por lo tanto, el lenguaje está lateralizado, presente generalmente en el hemisferio izquierdo del cerebro, aunque en ocasiones puede aparecer lateralizado en el hemisferio derecho (Knecht et al., 2000a), y está relacionado con la dominancia manual,

---

14 La disfasia es un trastorno del habla producido por una lesión cerebral y que consiste en una falta de coordinación de las palabras.

15 La afasia de conducción es un trastorno del lenguaje que consiste en la alteración de la repetición, la nominación, la lectura y la escritura.

16 La afasia es un trastorno del lenguaje, producido por lesiones cerebrales, caracterizado por la incapacidad o la dificultad de comunicarse mediante el habla, la escritura o la mímica.

17 La afasia cruzada es una alteración del habla que se produce por una lesión hemisférica derecha en personas diestras y suele manifestarse por trastornos en la fluidez del habla, con mutismo inicial.

aunque su relación es compleja. Luria (1976) se dió cuenta de que la relación entre dominancia manual y lateralización del habla no era universal, es decir, que había zurdos que presentaban afasia, con lesiones en el hemisferio izquierdo.

Hoy en día se sabe que el hemisferio izquierdo es dominante para el lenguaje y que existe una relación sistemática entre lateralidad manual y lenguaje que ha sido demostrada en numerosas ocasiones (p.e. Knecht et al., 2000a, 2000b; McManus, 1985; Papadatou-Pastou, 2011). Se han realizado numerosos estudios sobre la relación entre la dominancia manual y la lateralización del lenguaje en enfermos de afasia con daños cerebrales en uno de los hemisferios. Sin embargo, los pacientes suelen presentar lesiones solo en uno de los hemisferios, por lo que siempre se puede dudar sobre la dominancia hemisférica del lenguaje (Pedersen et al., 1995). Por ello, cuando la mejora de las técnicas de monitorización cerebral como la imagen por resonancia magnética funcional (fMRI) o la ultrasonografía Doppler transcraneal (fTCD) lo permitieron, algunos científicos comenzaron a estudiar pacientes sanos para relacionar la lateralización del lenguaje con la dominancia manual. En esa línea se enmarcan los trabajos de Pujol et al. (1999) que examinaron el área de Broca de cien individuos sanos utilizando la fMRI. Además de detectar la relación entre dominancia manual y lateralización del lenguaje, también observaron que la dominancia diestra del lenguaje depende también del grado de lateralidad manual. Knecht et al. (1998) y Knecht et al. (2000b), analizaron 188 y 326 individuos sanos respectivamente utilizando la fTCD, confirmando los resultados de Pujol et al. (1999). En estos trabajos utilizaron el Inventario de Edimburgo (Oldfield, 1971) para determinar la lateralidad manual y estudiaron a los sujetos mientras realizaban tareas de generación de palabras. En sus estudios, detectaron que el 27% de los zurdos poseían una dominancia del lenguaje en el hemisferio derecho, mientras que solo un 4% de los diestros presentaban una dominancia del lenguaje en el hemisferio derecho. Según Knecht et al. (Knecht et al., 2000a), sus resultados demuestran que la relación entre dominancia manual y lenguaje no es un artefacto de una patología cerebral, sino que responde a un fenómeno natural. Corballis (2003) sugiere que la evolución del lenguaje se basa en una asociación entre gestos y lenguaje, y que la lateralización del lenguaje es la responsable del uso asimétrico de las manos. Por lo tanto, el estudio de la lateralidad manual



puede ayudarnos a comprender la biología del lenguaje (McManus, 1991).

Por otra parte, el cerebelo también está implicado en la producción del lenguaje (S. Häberling y Corballis, 2015). Según Häberling y Corballis (2015), las conexiones entre el cerebelo y la corteza son contralaterales, y las funciones asimétricas de la corteza se reflejan en el cerebelo. De esta manera, el lenguaje activa el lado del cerebelo opuesto al hemisferio dominante para el lenguaje.

### 2.5.3 Diferencias culturales, por status socio-económico y por sexo de la lateralidad manual

Se han realizado numerosos estudios midiendo los niveles poblacionales de lateralidad de diversas comunidades de diferentes lugares geográficos. En estos casos, la lateralidad manual se puede medir de dos maneras diferentes, de acuerdo con dos cuestiones: habilidad y preferencia. La preferencia se determina preguntando directamente al individuo u observando qué mano utiliza como dominante para realizar una tarea determinada. La habilidad se mide comparando la destreza de la mano derecha y de la mano izquierda para realizar la misma tarea. Estas dos cualidades están fuertemente relacionadas (McManus y Bryden, 1991). Para realizar este tipo de mediciones se suelen utilizar inventarios tales como el famoso Inventario de Edimburgo (Oldfield, 1971), que consiste en una serie de tareas estándar pre-configuradas: escribir y dibujar, lanzar, uso de tijeras, uso de cepillo de dientes, uso de raqueta de tenis, uso de cubiertos, uso de escoba y recogedor y repartir naipes. Existen también otros inventarios diferentes (Annett, 1967; Bryden, 1977; Coren et al., 1979; Crovitz y Zener, 1962) basados en el de Oldfield (1971).

Cuando se realizan estos estudios, y se mide la lateralidad en diferentes poblaciones, es importante tener en cuenta varios factores que potencialmente puedan tener influencia en la lateralidad. Habitualmente, se contemplan cuatro factores: el origen geográfico-cultural, el estatus socio-económico, el sexo y la edad del sujeto. Estos factores, en muchos casos, están relacionados entre sí, y es difícil estudiarlos de manera aislada.



Entre estos estudios podemos citar, por ejemplo, los realizados por Brito et al. (1989) en Brasil. Estudiaron a 959 individuos utilizando una forma abreviada del inventario de Edimburgo, obteniendo resultados similares al de otros países. Carrière et al. (2000) estudiaron la lateralidad en un contexto de lucha con arma blanca, en el grupo étnico de Ntumu, en el sur de Camerún, basándose en la dominancia manual para el uso del machete, herramienta utilizada diariamente por esta comunidad. Detectaron una preferencia para el uso de esta herramienta de la extremidad izquierda en un 8,1% de los casos. En otro estudio realizado por Levander y Schalling (1988), analizaron la lateralidad de 921 estudiantes de colegio suecos realizando tareas tales como escribir, dibujar, lanzar un balón, utilizar unas tijeras, pintar con pincel, cortar con un cuchillo o usar un martillo. Detectaron que un 62% de los individuos estudiados utilizaban la mano derecha para realizar todas las tareas, mientras que solo un 4% utilizaban la mano izquierda para realizar todas las tareas. Los porcentajes para la tarea de escritura suponían un 9% y un 89% para zurdos y diestros respectivamente. De esta manera detectaron que el grado de lateralidad depende de la tarea que se está realizando.

En otros estudios se comparan poblaciones de diferentes lugares y con diferencias culturales importantes. Este es el caso del estudio llevado a cabo por Connolly y Bishop (1992) en el que midieron la lateralidad y compararon una muestra de 125 niños ingleses con otra de 185 jóvenes de Papua Nueva Guinea, repartidos en dos grupos. En este estudio controlaron las variables de procedencia (Inglaterra o Papua Nueva Guinea) y de sexo, y registraron si los individuos presentaban experiencia escolar o no. La lateralidad de cada individuo se determinó utilizando un inventario de nueve tareas (uso de cuchara, lápiz, tijeras, cerilla y martillo, construir con bloques, repartir cartas, enhebrar un cordón y lanzar objetos). En este trabajo, como en los anteriores, se detectó en ambas poblaciones una preferencia generalizada por el uso de la mano derecha. Sin embargo, si observaron ligeras diferencias entre ambas poblaciones, siendo los grupos estudiados de Papua Nueva Guinea, los que presentaban una mayor dominancia de la mano derecha. No encontraron ninguna relación entre la preferencia manual y la escolarización, ni tampoco entre la lateralidad y el sexo. Sólo en la tarea de escritura en concreto, se observó que los niños no escolarizados presentaban una

dominancia de la mano izquierda menor (6,8%) que la de los niños escolarizados (10,98%). Además, atendiendo a cada tarea en particular, observaron que había tres de ellas que presentaban fuertes diferencias entre las dos poblaciones: construir con bloques, repartir cartas y enhebrar un cordón. Esto determina que, dependiendo qué tarea analicemos, podemos obtener grados de lateralidad diferentes.

Bryden et al. (1993) estudiaron un total de 65 adolescentes tucanos, originarios de la región amazónica de Colombia, mediante un cuestionario de 26 elementos, con resultados muy diferentes a los observados en poblaciones de Estados Unidos. Todos los individuos eran diestros, pero observaron diferencias en la habilidad, concluyendo que el refuerzo positivo en el uso de una de las manos, a cierta edad, puede alterar la dominancia manual. De esta manera, se deduce que la preferencia de la mano es el precursor de las diferencias de habilidad, y no al revés.

En muchos de los trabajos mencionados anteriormente, en los que diversos autores han estudiado la lateralidad en diferentes puntos geográficos, como hemos comentado anteriormente, han controlado también las variables de sexo para cada individuo y de esta manera, han analizado también la relación entre lateralidad y sexo. Numerosos de estos estudios han detectado diferencias de lateralidad entre los dos sexos (Brito et al., 1989). Sin embargo, en otros estudios no han encontrado diferencias de lateralidad entre los sexos, como es el caso del estudio realizado en Camerun en la tribu de Ntumu (Carrière y Raymond, 2000) o el realizado en Suecia en estudiantes de colegio (Levander y Schalling, 1988).

Debido a la cantidad de estudios llevados a cabo sobre diferentes poblaciones, Raymond y Pontier (2004), realizaron un análisis global de la lateralidad, basándose en estudios previos (tabla 2.1). Durante el siglo XX se realizaron numerosos estudios en los que midieron la lateralidad utilizando diferentes métodos, y realizando diversas tareas funcionales (p. ej. escribir, lanzar,...) y arbitrarias (p. ej. rapidez en mover objetos,...) (Harris, 1992). En este caso, para poder comparar los diferentes estudios, los autores se centraron solo en lo que se conoce como “interacciones agresivas”, basadas en tareas relacionadas con la lucha: “lanzar”

y “martillar”. Según ellos, estas tareas, están presentes en todas las culturas, a diferencia, por ejemplo, de la tarea “escribir” (Raymond y Pontier, 2004). Otra de las diferencias entre los estudios que analizaron es la de la recogida de datos. En algunos casos se conoce la lateralidad del individuo a partir de cuestionarios o entrevistas y en otros casos, directamente a partir de la realización de alguna tarea (Raymond y Pontier, 2004). Para ello, dividen los datos utilizados en dos categorías: datos recogidos a partir de la realización de la tarea (Annett, 1970; Connolly y Bishop, 1992; Plato et al., 1984; Quinan, 1930, 1922; Wilson y Jones, 1932), datos recogidos mediante cuestionarios (Annett, 1970; Brito et al., 1989; Bryden, 1977; De Agostini et al., 1997; Dellatolas et al., 1988; Gilbert y Wysocki, 1992; Komai y Fukuoka, 1934; Nedjar et al., 1989; Perelle y Ehrman, 1994; Portal y Romano, 1998; Wittenborn, 1946). Para el caso de los trabajos que medían la lateralidad a partir de una tarea realizada (“lanzar”), según los resultados de Raymond y Pontier (2004), a pesar de que todas las poblaciones estudiadas eran predominantemente diestras, existe una variación pequeña en el número de zurdos encontrados en los 3 países estudiados: 19,6% de zurdos en Papúa Nueva Guinea, 7,1% de zurdos en Estados Unidos de América, 12,4% de zurdos en Reino Unido. Detectaron que el país de procedencia era la variable más fuerte, ya que explicaba el 84,5% de la desviación, es decir, que las variables edad y sexo no eran relevantes. Para el caso de la tarea de “martillar” los resultados fueron los siguientes: 15% de zurdos en Papúa Nueva Guinea (Connolly y Bishop, 1992), 7% de zurdos en Estados Unidos de América (Plato et al., 1984; Quinan, 1930, 1922), 8,9% de zurdos en Reino Unido (Connolly y Bishop, 1992). En el caso del análisis de los estudios previos con base en cuestionarios, dividieron la muestra en dos dependiendo del tipo de cuestionario utilizado y denominadas de la siguiente manera: PER para el cuestionario utilizado por Perelle y Ehrman (1994) y OT para el resto de cuestionarios. También se detectó que el lugar de procedencia era la variable determinante que explicaba el 99,8% de la desviación para la tarea de “lanzar”. Obtuvieron resultados que oscilaban entre el 5% de zurdos para Japón, y el 22% de Côte de Ivore. Por otro lado encontraron que para la tarea de “martillar”, la proporción de zurdos oscilaba entre 11,4% de zurdos para Algeria, Costa de Marfil, Sudán y Reino Unido y un 15% de zurdos para el caso particular de Francia. El efecto de la variable sexo se mantiene constante, según Raymond y Pontier (2004), a lo largo de todos los países, con una mayor proporción

de mujeres zurdas para el caso del conjunto de datos PER, a excepción de algunos países del conjunto de datos OT, en los que hay mayor proporción de hombres zurdos.

% zurdos	País	Tarea	Método	Autores del estudio
19,6	Papua Nueva Guinea	Lanzar	Tarea	Raymond y Pontier (2004)
7,1	Estados Unidos de America	Lanzar	Tarea	Raymond y Pontier (2004)
12,4	Reino Unido	Lanzar	Tarea	Raymond y Pontier (2004)
15	Papua Nueva Guinea	Martillar	Tarea	Connolly y Bishop (1992)
7	Estados Unidos de America	Martillar	Tarea	Plato et al. (1984) Quinan (1930, 1922)
8,9	Reino Unido	Martillar	Tarea	Connolly y Bishop (1992)
5	Japón	Lanzar	Cuestionario	Raymond y Pontier (2004)
22	Costa de Marfil	Lanzar	Cuestionario	Raymond y Pontier (2004)
11,4	Algeria, Costa de Marfil, Sudán y Reino Unido	Martillar	Cuestionario	Raymond y Pontier (2004)
15	Francia	Martillar	Cuestionario	Raymond y Pontier (2004)
15	Botswana (tribu G /wi San)	Varias herramientas	Video	Marchant et al. (1995)
21	Namibia (tribu Himba)	Varias herramientas	Video	Marchant et al. (1995)
16	Venezuela (tribu Yanomamo)	Varias herramientas	Video	Marchant et al. (1995)
10,2	Gabón (tribu Baka)	Machete	Tarea	Faurie et al. (2005)
6,35*	Burkina Faso (Bobo-Dioulasso)	Machete	Tarea	Faurie et al. (2005)
26,9	Indonesia (tribu Eipo)	Tiro con arco	Fotografía	Faurie et al. (2005)

Tabla 2.1 Porcentaje de zurdos en diferentes países en función de la tarea realizada y el método que se ha utilizado para medir la lateralidad según diferentes autores.\*Solo para el caso de varones.

En 1995, Marchant et al. realizan un estudio en tres poblaciones no industrializada: la tribu G /wi San en Botswana, la tribu Homba en Namibia y la tribu Yanomamo en Venezuela. En este estudio analizaron dos tipos de tareas, unas implicaban el uso de herramientas y otras no, a partir de filmaciones previas. Detectaron grandes diferencias entre estos dos tipos de tareas, detectando que las que no implicaban el uso de herramientas se aproximaban al ratio zurdo/diestro de 50/50 (Marchant et al. 1995). Sin embargo, en las tareas que implicaban el uso de algún tipo de herramienta detectaron un 15% de zurdos en el caso de Botswana, un 21% en el caso de Namibia y un 16% en el caso de Venezuela (tabla 2.1).

A parte de los llevados a cabo por Marchant et al. en 1995, la mayor parte de los estudios se han llevado a cabo en sociedades occidentalizadas, por ello, en 2005, Faurie et al.

realizaron un estudio en tres poblaciones no occidentalizadas: La tribu Baka de Gabón, una población de la zona de Bobo-Dioulasso en Burkina Faso y la tribu Eipo de la zona de Irian Jaya en Indonesia. En los dos primeros casos analizaron la dominancia manual mediante la observación de una tarea, el uso del machete. Detectaron un 10,2% de zurdos en la población de Gabón. En el caso particular de Burkina Faso detectaron grandes diferencias entre ambos sexos. Observaron un 6,35% de zurdos entre los hombres pero no detectaron ninguna zurda entre las mujeres. En el caso de la tribu Eipo de Indonesia, detectaron un 26,9% de zurdos para la tarea de tiro con arco, observada a partir de fotografías (tabla 2.1)

Por lo tanto, a pesar de que existe un control genético de la lateralidad manual, cuestiones como la cultura, el estado socio-económico o incluso el sexo y la edad, influyen fuertemente en los niveles poblacionales y en la propia dominancia manual del individuo. Incluso el tipo de tarea que utilizemos para medirla, su naturaleza y su complejidad, influye sobre el sentido e intensidad de nuestra dominancia manual. Por lo tanto, debemos comparar con cautela la lateralidad manual de una población prehistórica con la de las actuales, y tener cuidado al contrastar las tareas con las que hoy en día se mide la dominancia manual (p. e. la escritura) con las que pudieran realizar nuestros antepasados.

## **2.6 Arqueología cognitiva: Lateralidad y dominancia manual a partir de materiales arqueológicos**

La Arqueología tiene el potencial de contribuir de manera importante al estudio de la inteligencia (Wynn, 1985). Como apuntaba Mithen (1996a), si quieres conocer la mente, “no consultes sólo a psicólogos, consulta también a un arqueólogo” (Mithen, 1996a). Por ello, debemos ser capaces de extraer la máxima información posible de los restos arqueológicos para comprender el comportamiento y la mente de nuestros antepasados. Sin embargo, los homínidos han sufrido durante su evolución cambios en su comportamiento y en su mente que no han dejado huella o la huella que han dejado resulta difícil de detectar (Thornton, 2012). Con el objetivo de extraer información sobre la mente humana del registro arqueológico surge la Arqueología cognitiva (Donald, 1991; Dunbar, 1996; Mellars y Gibson,

1996; Mellars y Grün, 1991; Mithen, 1996b; Plotkin, 1982; Renfrew y Zubrow, 1993; Renfrew, 2007). Debido a que es la mente humana la que ha creado el útil podemos obtener información sobre la cognición humana a través del estudio de la industria lítica (Sánchez et al., 2015). En las últimas décadas, los estudios tipológicos de útiles prehistóricos se han completado con análisis que incluyen enfoques etológicos y cognitivos. Dentro del marco de la Arqueología cognitiva, el estudio de la dominancia manual a través de los útiles puede ayudarnos a comprender el comportamiento y el funcionamiento de la mente de nuestros antepasados.

El estudio de la mente humana requiere la comprensión del funcionamiento de nuestro cerebro, su articulación interna, sus orígenes y su evolución a lo largo de la historia de nuestro género (Stout et al., 2000). Determinadas funciones cerebrales, especialmente desarrolladas en el ser humano, como el habla, la abstracción o el pensamiento complejo, se ubican físicamente de manera lateralizada en nuestro cerebro (Corballis, 2005; Llorente, M., et. al. 2008; McManus, 1991, 1985; Rogers, 1993). Relacionada con estas funciones de distribución asimétrica, emerge la capacidad conocida como lateralidad, que consiste en asignar roles distintos a cada una de nuestras extremidades cuando realizamos una tarea determinada (Marchant et al., 1995). Hoy día, esta capacidad sólo se manifiesta de manera contundente en nuestra especie de primates, por lo que tuvo que aparecer en algún punto de la evolución del género humano. Mediante el estudio del comportamiento lateralizado, comprendemos mejor la organización cerebral y sus asimetrías, del mismo modo que, al analizar el origen y el desarrollo de la lateralidad, ganamos perspectiva histórica y podemos entender cuándo surgieron las asimetrías cerebrales y cómo han evolucionado a lo largo de la historia del género *Homo*. El comportamiento humano lateralizado puede haber quedado reflejado en los productos de la actividad tecnológica, y especialmente en los artefactos manufacturados (Uomini, 2011).

En esta tesis se desarrolla, por un lado, un método para establecer la lateralidad manual a partir de hachas pulimentadas, útil muy extendido durante el Neolítico y Calcolítico (Dominguez-Ballesteros y Arrizabalaga, 2014) y, por otro lado, un método para establecer

la lateralidad manual a partir de restos líticos, producidos como resultado de la talla lítica, en los que se conserve el talón, generalmente lascas o útiles sobre lasca (Dominguez-Balasteros y Arrizabalaga, 2015). En el caso de la metodología aplicable a pulimentos, no se han realizado estudios previos en esta materia, por lo que el método propuesto en esta tesis es pionero. Sin embargo, como detallaremos a continuación, sí que existen varios estudios previos, aunque escasos, que proponen métodos diseñados para deducir la lateralidad manual a partir de restos producidos a partir de la talla lítica.

La actividad de talla lítica, inherente a nuestro género desde los primeros estadios de su evolución, constituye un registro abundante, de conservación habitualmente buena y una fuente potencial de información para el estudio diacrónico del proceso de lateralización en distintas especies humanas.

Los primeros trabajos que se plantean desde el punto de vista del estudio de la lateralidad manual a través de los restos arqueológicos son de Semenov (1964) que realiza estudios experimentales en útiles paleolíticos atendiendo también a cuestiones relacionadas con la dominancia manual. Más adelante, el primero en hacer un estudio completo sobre la lateralidad manual a partir de restos líticos es Toth (1985). Las conclusiones de su trabajo se fundamentaban en la hipótesis de que la lateralidad influye en la dirección en la que se gira el núcleo a la hora de ser tallado. Según Toth, un tallista diestro giraría el núcleo, a medida que va extrayendo lascas, en sentido dextrógiro. Este hábito provocaría una tendencia en el decorticado a producir lascas con el cortex en su lado derecho, mientras que en un tallista zurdo se produciría el efecto contrario. Desde finales del siglo XX, tras el trabajo pionero de N. Toth (1985), el interés por obtener información relativa a la lateralidad a partir del registro lítico es creciente. Posteriores trabajos experimentales (Patterson y Sollberg, 1986) establecieron que la configuración geométrica del núcleo es más determinante que el sentido de rotación del núcleo respecto a la última lasca extraída y que, de esta manera, un tallista zurdo puede producir cierto número de lascas diestras, y viceversa. En la experimentación efectuada, Sollberg produjo un 56% de lascas diestras (según la nomenclatura de Toth), siendo zurdo. En un estudio realizado por Pobiner (1999), con siete alumnos diestros de la



Universidad de Pensilvania, fueron analizadas las 284 lascas producidas en sucesivas sesiones de talla y determinaron que, a medida que aumentaba el número de lascas producidas, el ratio de lascas diestras:zurdas se aproximaba a 50:50. Es decir, el método de Toth solo puede ser aplicado a una estrategia de reducción específica, en la que se extraigan lascas de una misma plataforma siguiendo una secuencia determinada. Es importante, por lo tanto, encontrar un método que no se sustente en los hábitos de talla, planteando hipótesis basadas en elementos relacionados directamente con la percusión, como por ejemplo, el ángulo y dirección de incidencia del percutor sobre la plataforma de percusión. Precisamente en esa línea, Rugg y Mullane (2001) estudiaron la orientación del cono de percusión de la lasca, condicionado por la dirección del ángulo de percusión. En su experimento, analizaron 299 lascas, entre las cuales 75 son consideradas válidas para determinar la lateralidad del tallista. En esta colección restringida, en el 75% de los casos fueron capaces, según ellos, de determinar la lateralidad correctamente. Los trabajos de Rugg y Mullane (2001) representaron un significativo avance en el análisis de la industria lítica desde la perspectiva de la lateralidad. Sin embargo, recientemente (Bargalló et al. 2013) quedó demostrado que el método de Rugg y Mullane, por sí solo, no permite determinar la lateralidad del tallista. Analizando el cono de percusión y otras características presentes en las lascas, desarrollaron un sistema que permite determinar la lateralidad del tallista a partir de varias lascas producidas por un mismo individuo. Mediante este método se puede determinar la lateralidad de un tallista particular a partir del remontaje de varias de sus lascas. Sin embargo, este sistema no es aplicable a cada lasca singular y se limita al estudio de remontajes líticos. Desgraciadamente, la mayor parte de los conjuntos líticos no pueden ser remontados, por lo que sería interesante contar con un método que permita establecer, con cierta seguridad, la lateralidad del tallista, incluso a partir de una lasca aislada. Los métodos propuestos hasta la fecha plantean requerimientos que hacen muy difícil contar con una muestra amplia dentro de una determinada colección. Dicho de otro modo, si queremos obtener unos resultados extensivos y susceptibles de ser considerados estadísticamente pertinentes, incluso sobre colecciones no muy grandes, debemos identificar y evaluar un rasgo indicador de la lateralidad del tallista con alta prevalencia en las series prehistóricas. Este es el objetivo principal de esta tesis.



## **2.7 Otras formas de inferir la lateralidad en humanos prehistóricos**

En esta tesis hemos estudiado la lateralidad manual a partir del registro arqueológico, concretamente a partir de las lascas con talón y las hachas pulimentadas. Sin embargo, a parte del método propuesto en esta tesis y de los métodos que hemos descrito en el apartado anterior, que también se basan en el estudio del registro arqueológico, existen otros métodos para inferir la lateralidad manual de las poblaciones del pasado. Los resultados obtenidos en esta tesis a partir de la metodología que hemos desarrollado pueden ser combinados y comparados con los obtenidos mediante estos otros métodos. En este apartado describiremos algunos de los más importantes que se han desarrollado para inferir la lateralidad manual.

Existen numerosos trabajos que han tratado asociar la lateralidad manual, directamente de los huesos del individuo, estudiando poblaciones actuales, donde la lateralidad del sujeto se conocía previamente. Danforth y Thomson (2008) tomaron diferentes medidas en clavículas, húmeros, radios y ulnas y no encontraron ninguna relación de éstas con la dominancia manual del individuo. Sin embargo, otros autores mantienen que sí existe tal relación. Según Auerbah y Ruff (2006), nuestros antepasados llevarían unas vidas más físicas y usarían sus extremidades superiores más enérgicamente y los indicios de dominancia manual quedarían más marcados en los huesos. Trinkaus et al. (1994) tomaron varias medidas en húmeros de cinco neandertales y determinaron que no había diferencias entre el brazo derecho y el izquierdo, tomando las medidas externas como referencia, pero que si que las había si tomábamos como referencia el grosor cortical del húmero o el área medular. Según estos autores, existen evidencias de que los neandertales utilizaban predominantemente uno de los brazos (Trinkaus et al., 1994).

También se han utilizado las estriaciones dentales para determinar la lateralidad manual de los individuos. Según Bermúdez de Castro et al. (1988), al utilizar la técnica “stuff and cut”, empleada actualmente por los esquimales, y que consiste en cortar un tejido (carne, cuero,...) sujetando un extremo del mismo con los dientes, se producen una serie de cortes diagonales en los incisivos o caninos del sujeto (Lozano et al., 2004). Estudiando estas

marcas mediante la experimentación, se pueden asociar las preservadas en los dientes con la lateralidad manual del sujeto (Frayer et al., 2011; Frayer et al., 2016).

También se han estudiado las marcas de uso en los filos de los útiles que utilizaban los homínidos de Galería (Atapuerca, España), con resultados de una dominancia manual diestra (Ollé, 2003), y las marcas de carnicería, atendiendo a la fracturación y los patrones de estriación de las marcas de corte presentes en los huesos (Bromage y Boyde, 1984; Bromage et al., 1991).

En el ámbito del arte prehistórico, se ha intentado asociar la lateralidad del individuo a través de los diferentes elementos artísticos. Las formas conocidas como manos en negativo han sido estudiadas extensamente desde la perspectiva de la lateralidad. Se cree que estos elementos artísticos se realizaban soplando pigmento mediante un tubo que se sujeta con una mano y proyectándolo, a modo de aerosol, sobre la otra mano, que se apoya en la pared. De esta manera, se dibuja un negativo de la mano sobre la que se difumina el pigmento. Groënen (1988) estudió las impresiones de manos en las cuevas francesas del Paleolítico superior, y determinó que un 77% de ellas estaban hechas sujetando el tubo de pigmento con la mano derecha, dejando la impresión de la mano izquierda sobre la pared. Faurie y Raymond (2004) realizaron un estudio comparando las impresiones de manos paleolíticas con las realizadas por alumnos universitarios, de los que previamente se había determinado su lateralidad manual.

## **2.8 Recapitulación**

La lateralidad es una cualidad que presentan algunos animales y que consiste en asignar diferentes roles a cada lado del cuerpo cuando llevan a cabo una tarea determinada (Guiard, 1987). La lateralidad está relacionada con las asimetrías cerebrales y se ha demostrado recientemente que tanto las asimetrías en el cerebro como en el comportamiento están presentes en algunos invertebrados y que la especialización de cada hemisferio cerebral estaba ya presente en los primeros vertebrados.

El encéfalo humano está formado por el cerebro, el cerebelo, que se encuentra bajo él, el tálamo, el hipotálamo, los colículos, el puente y el bulbo raquídeo. El cerebro está compuesto por la corteza, el hipocampo, los ganglios basales y el bulbo olfatorio. La corteza cerebral, a su vez, está dividida en dos mitades, conocidas como hemisferios cerebrales, separados por la cisura interhemisférica y conectados entre sí por el cuerpo caloso. El cerebro es un órgano que presenta un funcionamiento muy complejo y para comprenderlo debemos estudiarlo desde diferentes puntos de vista. Por ello, no podemos descartar la información que puede aportarnos el estudio de los restos arqueológicos sobre la cognición, la etología y la evolución del cerebro de quienes produjeron esos útiles y más concretamente, sobre las asimetrías cerebrales, reflejadas en los útiles a través de la lateralidad manual. La corteza cerebral presenta una naturaleza homogénea a simple vista, por lo que es difícil observar directamente estructuras diferenciadas. El primer mapa cerebral, conocido como “mapa de Brodman”, donde se representan 51 áreas, corresponde con una clasificación meramente fisiológica. Por lo que para asociar estas áreas con las diferentes funciones cerebrales necesitamos métodos específicos. El estudio de pacientes que han sufrido algún tipo de daño cerebral localizado, permitió el avance de estos estudios, antes de que aparecieran técnicas de monitorización cerebral como la Imagen por Resonancia Magnética Funcional (fMRI).

Una de las primeras funciones asimétricas que fue detectada es el lenguaje, examinando post mortem cerebros con afasia (Wernicke, 1874). La producción del lenguaje y algunos aspectos del procesamiento de la sintaxis han sido localizados principalmente en el lóbulo frontal del hemisferio izquierdo (Área de Broca), mientras que la comprensión del lenguaje se ha localizado principalmente en el límite entre el lóbulo parietal y el lóbulo temporal del mismo hemisferio (Área de Wernicke). La lateralidad manual está relacionada con las asimetrías funcionales de las estructuras del procesamiento del lenguaje (Witelson y Kigar, 1992). No obstante, la relación entre ambas no es estricta, los diestros presentan las funciones del lenguaje lateralizadas en el hemisferio izquierdo en un 97% de los casos, y los zurdos sólo en un 70%.

La relación entre las asimetrías cerebrales y la lateralidad manual con las funciones visua-

les han sido objeto de debate durante el siglo XX. Según Mapp et al. (2003), cualquier tipo de dominancia (ocular, manual,...) es debida a una única causa: la especialización hemisférica. Las extremidades de cada lado se comunican única y exclusivamente con uno de los hemisferios (y a través del cuerpo calloso, con el otro), mientras que los ojos se comunican directamente con ambos hemisferios, y el movimiento de los músculos oculares emerge de ambos hemisferios, dependiendo de hacia dónde se desee mover los ojos.

El estudio de pacientes con el cuerpo calloso seccionado ha supuesto un avance en el estudio de las asimetrías cerebrales. Este fenómeno, conocido como desconexión interhemisférica fue detectado por Wernicke (1874) y estudiado por Dèjerine (1892). Posteriormente, con el objetivo de poner en marcha un tratamiento contra la epilepsia se comenzó a seccionar el cuerpo calloso. En un ataque epiléptico la convulsión comienza en una zona localizada del cerebro y a partir de ahí se extiende al resto del mismo. Al estar seccionado el cuerpo calloso no existe comunicación entre los dos hemisferios por lo que la el ataque no solo se extiende en uno de los hemisferios, y en consecuencia, a un único lado del cuerpo. De esta manera el paciente podía controlar el otro lado del cuerpo durante el ataque. Posteriormente se comenzaron a estudiar estos pacientes y a comprender como funcionan las asimetrías cerebrales en profundidad y como se comunican ambos hemisferios. La aparición de la Imagen por Resonancia Magnética Funcional (fMRI) ha permitido descubrir diferencias funcionales entre los hemisferios, y numerosos estudios se han centrado en el lóbulo temporal, relacionado con la lateralidad y el lenguaje.

En conclusión se conoce que algunas asimetrías anatómicas cerebrales están relacionadas con la lateralidad manual y que de la misma manera, funciones asimétricas en nuestro cerebro, como por ejemplo el lenguaje o las habilidades espaciales, guardan una relación directa pero compleja con la dominancia manual.

En el reino animal las asimetrías cerebrales y la lateralidad manual aparecen de manera extendida y variable. En el medio acuático, los animales sésiles muestran simetría radial, mientras que lo planctónicos presentan simetría cónica, debido probablemente a que en su

medio de vida, los depredadores pueden acercarse desde una dirección u otra. Los animales nectónicos, por el contrario, han desarrollado evolutivamente la diferencia entre parte anterior y posterior, y los animales terrestres, debido a que caminan sobre una superficie, han desarrollado la diferencia entre parte interior y superior. A pesar de ello, el medio acuático, terrestre o aéreo no posee de por sí ninguna peculiaridad que propicie evolutivamente la lateralidad, y por eso, en general, los peces, reptiles, pájaros y mamíferos mantienen esa simetría bilateral anatómica invariable. Así todo, la asimetría bilateral existe, tanto a nivel anatómico como cognitivo y está relacionada con la aparición de estructuras helicoidales aisladas.

Se ha descubierto recientemente que la lateralidad está presente a lo largo de todos los vertebrados, de hecho, la especialización de cada hemisferio en el cerebro humano ya estaba presente en los primeros invertebrados.

Se han observado asimetrías anatómicas en las vísceras de algunos peces y diferencias en la especialización hemisférica. Por ejemplo, los *Anableps anableps* poseen los órganos sexuales ubicados únicamente en un lado del cuerpo. En cuanto a su comportamiento, los peces, reptiles y sapos, por lo general, tienden a golpear a sus presas en su lado derecho, guiados por su ojo derecho. Los sapos, por ejemplo, dan caza a sus presas, en la mayoría de los casos, cuando la presa pasa por el campo de visión de su ojo derecho.

En cuanto a las aves, carecen de cuerpo calloso, por lo que presentan una comunicación interhemisférica muy limitada y la mayor parte de ellas poseen un control independiente de cada ojo. Los pollos interpretan los estímulos captados por su ojo izquierdo en función de su posición espacial y los captados por su ojo derecho según su categoría. También presentan lateralización de la memoria. En general, las aves poseen los órganos sexuales lateralizados, en las hembras, solo el ovario izquierdo es funcional, y en los machos, el testículo izquierdo es más grande. En cuanto al comportamiento de las aves, se ha detectado que los pollos están lateralizados respecto al miedo, ataque y copulación, funciones dominadas por el hemisferio derecho.

Entre los mamíferos, en las ratas se ha detectado dominancia diestra de las patas y presentan el hemisferio derecho más grande. Los gatos y perros, también tienen el hemisferio derecho más grande, pero en cuanto a la dominancia de las patas existen diferentes opiniones. Algunos autores creen que la práctica previa que pueda presentar el animal con una de las extremidades puede influir en la lateralidad observada. Los conejos, también presentan el hemisferio derecho más grande y el primer ojo que abren durante su desarrollo es el derecho, que se desarrolla más.

Los marsupiales también presentan lateralidad. El postúm australiano de cola de cepillo y el koala, por ejemplo, presentan dominancia de una de las patas.

Los mamíferos marinos, como las ballenas jorobadas, presentan por lo general abrasión debido a la alimentación solo en el lado derecho de las barbas. El narval, por ejemplo, presenta un desarrollo excepcional solo en uno de los colmillos y los delfines pueden dormir solo uno de sus hemisferios. En cuanto al comportamiento de este tipo de mamíferos, los delfines presentan asimetrías en su forma de nadar y los mamíferos voladores como los murciélagos, vuelan realizando espirales dextrógiras cuando salen de las cuevas.

En primates también se han observado asimetrías cerebrales, como por ejemplo en el macaco rhesus (*Macaca mulatta*), siendo mayor su hemisferio derecho y algunos primates presentan asimetrías cognitivas como, por ejemplo, los macacos cuyas vocalizaciones parecen estar más ligadas al hemisferio izquierdo. El estudio de la lateralidad en primates no humanos nos puede ayudar a comprender la evolución de la lateralidad en nuestro propio género.

En cuanto a la dominancia manual, parece ser más débil y variable en primates no humanos que en humanos. Entre los estepsirrinos, los gálagos menores (*Galaga senegalensis*) presentan una fuerte preferencia manual zurda para tareas de búsqueda de comida y entre los haplorrinos, los monos capuchinos presentan una preferencia por la mano derecha. Los tíes (*Callithrix jacchus*) están lateralizados para tareas como la búsqueda de comida, sostener comida, golpear o empezar a escalar y andar. Los monos cebus presentan fuertes preferencias

manuales individuales, los monos reshus (*Macaca mulatta*) una preferencia por el uso de la mano izquierda para tareas de discriminación táctil, los macacos japoneses (*Macaca fuscata*) preferencia por la mano izquierda para atrapar comida lanzada por los investigadores y los macacos de cerdo norteño (*Macaca leonida*) presentan dominancia manual para la realización de la tarea TUBE, que consiste en ofrecer al sujeto un trozo de comida introducido en un estrecho tubo.

En el caso de los simios antropomorfos, en general, no se han observado niveles poblacionales de dominancia manual en estos primates salvo para el caso de gestos y tareas específicas en grandes simios, en cambio, si se han observado diferencias individuales en bonobos y orangutanes en cautividad. En animales salvajes se ha detectado dominancia manual para el caso de chimpancés comunes, gorilas y orangutanes. El estudio de estos primates, particularmente los gorilas, debido a que presentan capacidades de manipulación no muy diferentes de las nuestras, permite establecer comparaciones interesantes ya que pueden utilizar herramientas y presentan habilidades comunicativas. Los chimpancés presentan una preferencia manual individual por la mano derecha para tareas unimanuales, y las hembras gorila presentan una preferencia por la mano derecha para agarrarse mientras sujetan a sus crías con la izquierda. Algunos estudios han demostrado preferencia por la mano izquierda en gibones y distribución bimodal en orangutanes. Para la búsqueda de comida a tres patas los grandes simios están muy levemente lateralizados y no muestran preferencia. Para la búsqueda bípeda presentan mayor preferencia por la mano derecha. Atendiendo a la alimentación se han detectado preferencias individuales en chimpancés salvajes, bonobos, gorilas salvajes y orangutanes. Los chimpancés salvajes también presentan una fuerte lateralización manual individual para realizar tareas donde una mano manipula el ítem mientras que la otra lo sujeta, como el procesamiento de frutos de Saba y limones, pero sin presentar tendencias poblacionales. Sí se han detectado preferencias manuales a nivel poblacional para el uso de herramientas en chimpancés, concretamente en la “captura de termitas”. En el caso de orangutanes y bonobos también se han detectado preferencias manuales en el uso de herramientas. Según Hopkins et al. (2011) los chimpancés y gorilas adultos presentarían niveles poblacionales de dominancia manual diestra, los orangutanes niveles poblacionales

de dominancia manual zurda y los bonobos estarían en el límite de la dominancia manual diestra poblacional.

Los seres humanos presentan una fuerte lateralidad y grandes asimetrías cerebrales. Hoy en día no se conocen sociedades humanas actuales en las que la mayoría de sus miembros sean zurdos, no tampoco sociedades carentes de zurdos. Sin embargo, el número de zurdos en las poblaciones es variable. La dominancia manual poblacional solo se manifiesta tan explícitamente en el caso del ser humano, debido a que está relacionada con una característica exclusiva del ser humano: el habla. Estas cuestiones hacen que la lateralidad en nuestro género sea compleja de analizar y ha suscitado un gran interés entre la comunidad científica.

Se conoce muy poco sobre los factores ambientales o genéticos que rigen las asimetrías del sistema nervioso central, actualmente el 8% de los humanos son considerados zurdos y las primeras observaciones sugieren un origen genético de la lateralidad manual, aunque los estudios en gemelos monocigóticos presentan ciertas discordancias. Los primeros modelos genéticos fueron propuestos por Ramaley (1913) y postulaban que la lateralidad manual zurda se heredaba como un carácter recesivo, según él la descendencia de dos progenitores zurdos debería ser zurda, lo cual no ocurre necesariamente. Levy y Nagylaki (1972) diseñaron otro modelo basándose en dos alelos pero que tampoco era capaz de explicar los datos obtenidos en gemelos.

Más recientemente se han postulado dos modelos en los que los diestros heredan una tendencia direccional para la dominancia manual cerebral del lenguaje y la dominancia motora que predispone a los individuos a ser diestros: la teoría conocida como “Right-shift theory” (Annett, 1985) y el modelo correctivo (McManus, 1991). Los primeros modelos se caracterizaban por asociar un alelo para cada fenotipo, los modelos recientes en cambio son asimétricos en el sentido de que un alelo no produce el efecto espejador del otro.

Por lo tanto, la lateralidad humana tiene una dimensión genética que es hereditaria y existen varias hipótesis que tratan de explicar los procesos evolutivos que dan lugar a la



presencia de zurdos en todas las sociedades actuales. En la hipótesis basada en la lucha (Raymond et al. 1996), los autores afirman que los problemas que puedan suponer ser zurdo son compensados en situaciones de lucha con un diestro, debido al factor sorpresa. En otra de esas hipótesis Calvin (1983), propone que las madres tienden a sujetar a sus bebés en el lado izquierdo, dejando libre su mano derecha para realizar tareas. Otra de estas hipótesis está relacionada con la emergencia del bipedalismo (Falk, 1987; Sanford et al., 1984; Westergaard et al., 1998) ya que dejaría libres ambas manos y como consecuencia se podrían desarrollar y mejorar las habilidades cerebrales, y además habría posibilitado la realización de tareas que están relacionadas con la emergencia de la lateralidad manual. La hipótesis “postural” (MacNeilage et al. 1987) postula que la primera especialización fue hemisférica y afectó a funciones manuales en prosimios, relacionadas con la búsqueda de comida mediante la vista, acompañada de una adaptación estructural relacionada con la locomoción, a través de la cual evoluciona la mano prensil. Kalakanis (2000) propuso la hipótesis de la dominancia dinámica a raíz de examinar las diferencias entre las dos extremidades superiores y su coordinación en tareas que implican alcanzar objetos, demostrando la ventaja del brazo dominante. Proponen que existen mecanismos neuronales diferentes para el control del brazo dominante y para el control del brazo no dominante. La teoría de la complejidad de la tarea sería otra de las hipótesis propuestas (Fagot y Vauclair (1991) según la cual la lateralidad manual en términos poblacionales es más probable que aparezca cuando las tareas son más complejas.

En cuanto al lenguaje y su relación con la lateralidad, Dax (1836) es el primero en asociarlo con las lesiones en el hemisferio izquierdo, más tarde, Broca (1861), identificó la tercera circunvolución frontal del hemisferio izquierdo como el centro para el lenguaje articulado, conocido como área de Broca y Wernicke (1874), asoció los defectos en la comprensión del lenguaje con daños en la mitad posterior de la circunvolución temporal superior, conocida actualmente como área de Wernicke. El lenguaje está lateralizado, presente generalmente en el hemisferio izquierdo del cerebro, aunque en ocasiones puede aparecer lateralizado en el hemisferio derecho, y está relacionado con la dominancia manual, aunque su relación es compleja. Con las nuevas técnicas de fMRI se observó que la dominancia diestra del lengua-

je depende también del grado de lateralidad manual, por lo tanto, el estudio de la lateralidad manual puede ayudarnos a comprender la biología del lenguaje.

Se han realizado numerosos estudios midiendo los niveles poblacionales de lateralidad en comunidades en diferentes lugares geográficos para estudiar la variabilidad de la lateralidad según el origen, estatus socio-económico, sexo y edad y atendiendo a dos variables: habilidad y preferencia. Para realizar este tipo de mediciones se suelen utilizar inventarios del tipo al inventario de Edimburgo (Oldfield, 1971) que analizan tareas como: escribir, lanzar, uso de tijeras,... La tabla 2.1 recoge algunos de estos estudios. Según estos estudios se puede observar que a pesar de que existe un control genético de la lateralidad manual, factores como la cultura o el estatus socio-económico pueden variar fuertemente los niveles poblacionales de lateralidad. Influye también la complejidad y naturaleza de la tarea que utilizemos para medir la lateralidad.

En esta tesis se desarrolla, por un lado, un método para establecer la lateralidad manual a partir de hachas pulimentadas y por otro lado, otro método para establecerla a través de las lascas. La arqueología tiene el potencial de contribuir de manera importante al estudio de la inteligencia por lo que debemos ser capaces de extraer la máxima información del registro arqueológico.

Los primeros estudios que se plantean el estudio de la lateralidad a través de los restos arqueológicos son de Semenov (1964). Posteriormente Toth (1985) desarrolla un método para establecer la lateralidad a partir de lascas corticales y Rugg y Mullane (2001) lo hacen analizando el bulbo de percusión. Más adelante, Bargalló y Mosquera (2013) desarrollan un método que permite identificar la lateralidad del tallista a partir de varias lascas producidas por él mismo. Otras formas de determinar la lateralidad de sociedades del pasado son el estudio de los huesos (Danforth y Thomson, 2008; Trinkaus et al., 1994), de las estriaciones dentales (Bermudez de Castro et al., 1988) o los estudios en arte prehistórico de las manos en negativo (Groënen, 1988).

**Chapter 3:**

# **Methodology**



### **3.1 Introducción**

The study of laterality and handedness can help us to understand the brain and its organization, and provide us information of the brain functions such as language, strongly related with laterality. In this chapter we developed several methods from which you can analyze the archaeological remains and obtain information of the laterality of the producers or the users. These methods should be applicable to a large sample to provide reliable data, statistically significant and allow us to make a quantitative analysis.

There are different approaches from which we can study the laterality of prehistoric societies. One of these approaches, whose methodology of work is more developed, is the study of bone or dental remains (Bermúdez de Castro et al., 1988; Frayer et al., 2011; Lazenby, 2002; Lozano et al., 2009; McManus, 1982; Trinkaus et al., 1994). However, the study of laterality, from an archaeological perspective, has not suffered the same development. The initial work of Toth (1985) were followed by criticism (Patterson and Sollberger, 1986; Pöbinger, 1999), so the study of laterality through the stone remains was temporarily dropped out. More than fifteen years later, other studies (Rugg and Mullane, 2011) activate again the interest, and then, Bargalló and Mosquera (2013), conducted new studies and developed a method to establish the laterality from the lithic remains. However, as we will detailed in this chapter, although experimentally have been successful, there are still some difficulties in applying these methods in prehistoric materials.

There is, therefore, an interest in evaluating, from the archaeological remains, the origins and the evolution of the laterality in our genus. However, during our history, humans used different techniques, which in some cases have nothing to do with each other. Therefore, we must design different methodological tools that can help us to detect laterality population levels in each cultural period. On the other hand, there is a genetic control of laterality (Annett, 1973; Armour et al, 2014; Brandler et al, 2013; And Nagylaki Levy, 1972; McManus, 1991; McManus et al, 2013.); however, the environment and cultural factors produce a strong control over it, such as the socio-economic status (Annett and Kilshaw,

1983; Faurie and Raymond, 2013; Leiber and Axelrod, 1981; Perelle and Ehrman, 1994) the geographical origin (Bryden et al., 1993; Holder and Kateeba, 2004; Marchant et al., 1995; McManus, 2009; Porac and Coren, 1981; Raymond and Pontier, 2004), or the degree of westernization of the individual (Faurie et al., 2005 Marchant et al., 1995). Thus, to understand the phenomenon of handedness throughout prehistory and its origins, it is important to understand the influence of culture and biology, which are the main agents that control it. Once we can design a method that allows us to establish the levels of laterality of non-industrial prehistoric societies, we can compare them with modern industrialized and non-industrialized societies and understand better the influence of biology and environment in the laterality of the different populations. In this thesis, we start studying laterality in the Neolithic and Chalcolithic societies, formed by individuals *Homo sapiens*, for which we have designed a method focused on polished axes. With the study of these societies, we aim to understand the influence of the cultural factor in pre-industrial populations formed by individuals of our species. The culture of each population determines its levels of laterality, as we can see when we compare, industrialized and non-industrialized current populations (Faurie et al., 2005 Marchant et al., 1995). Subsequently, the objective is to develop a method that allows us to evaluate the laterality along the Paleolithic, during which inhabit different species of *Homo*. Obviously, since in the Paleolithic the polishing technique was not yet developed, we must design a process that focuses on other archaeological remains. In this case we have developed a method based on the morphology of the flakes, an abundant product throughout the Paleolithic.

These two methods must fulfill certain requirements to be satisfactorily applicable to the archaeological record. First, we must consider that if we want to set the population-level laterality of any prehistoric society from his remains, we must focus our study in tools which are abundant in the archaeological record. To establish the levels of laterality, we must support our results on significantly statistical samples to be able to quantify them. On the other hand, the results should be based on nonperishable elements. Sometimes, some of the elements of the tools, despite being at the beginning very abundant, are not properly conserved, for example the handles of the axes or the percussion grooves of the flakes. In the

case of handles, to know how the tool was designed could provide extraordinary information from the point of view of laterality. However, the sample to be studied would be very small and would not have the desirable statistical significance, since these elements are rarely conserved. The case of percussion grooves, understood as the straight marks that leaves a hammer at the point of percussion in a flake, can bring us information about the laterality of the knapper, but disappear very easily.

In addition, we must design a method that is not supported on the producer's habits during the performance of the tools. The habits that a current knapper can personally acquire, such as the direction in which a core is rotated when successive flakes are extracted, can seem very natural, but it may not be shared by prehistoric knappers. Therefore, we should base our method on purely physical processes (fracture, percussion, friction,...), which are the same today and during prehistory. The method we have developed for the case of polished axes is based on the differential abrasion in the cutting edge area due to the centrifugal force caused by pivoting the arm from the shoulder, as will be detailed in this chapter. For the study of the flakes, we studied the impact forces and physical behavior of different materials, which determine the fracture.

Once designed each method, we test them through experimentation. In addition, this experiment should emulate the archaeological processes in the most reliable way. While it is important to design a prior experimentation, which could not reproduce accurately the way of prehistoric production, we must always ensure that our results are consistent with a real situation. In this work we performed some preliminary experiments that have allowed us to establish a methodological basis, which in some cases we have used artificial devices. However, it is very important to prove that at the end these methods work when applied to a real situation.

Keeping in mind what we have mentioned previously we have established the following general experimental procedure:

- i. Analyze the process of making a tool and identify by a previous experimentation the observable variables in the tools that may be related to the laterality of the producer or the user.
- ii. From these observations, develop a hypothesis.
- iii. Design a systematic experiment to relate the variables observed during the previous experimentation with the laterality of the producer or the user.
- iv. Develop a method based on the relationship between the different variables.
- v. Make a blind test to evaluate the method.
- vi. Make a suitability of the method for applicate it in the archaeological record.

To study laterality in past human societies, based on their archaeological heritage, several variables can be analyzed: on the one hand, the differences in the way the tool was made, to determine the laterality of its maker and, on the other hand, the different shapes of the tools, to establish the laterality of their users. The present study focuses on some characteristics of ground stone axes, which evidence the laterality of the artisan who made them. These tools constitute one of the main technological innovations associated with the first farming communities, in the Neolithic. As in the case of any new technology, the manufacture of ground stone axes and adzes implies decision-taking in the choice of raw materials, in the design of a new chaîne opératoire and, ultimately, in the functionality of the implements. In the case of the method developed for Palaeolithic societies, we focus on the fracture of a flint core to establish the laterality of the knapper. In this case, we analyzed a series of fractures, which sometimes are generated around the percussion point, and are preserved on the platform of the flakes. The abundance of flakes during the Paleolithic allows us to have the necessary sample to obtain statistically significant results.

### **3.2 Laterality through the polished axes**

To study laterality in past human societies, based on their archaeological heritage, several variables can be analyzed: on the one hand, the differences in the way the tool was made, to determine the laterality of its maker and, on the other hand, the different shapes of the



tools, to establish the laterality of their users. The present section focuses on some characteristics of ground stone axes, which evidence the laterality of the artisan who made them. These tools constitute one of the main technological innovations associated with the first farming communities, in the Neolithic. The methodology we develop in this section allow us to assess handedness levels in populations in a more primitive socioeconomic status, which can be compared with current populations of our human species. As in the case of any new technology, the manufacture of ground stone axes and adzes implies decision-taking in the choice of raw materials, in the design of a new chaîne opératoire and, ultimately, in the functionality of the implements. After a comparative analysis of ethno-archaeological data about human groups who made this kind of tool until recent times, or still make them, an experimental programme was designed to determine which characteristics of the tools indicate the laterality of its maker. The main morphological element susceptible of displaying a relationship appears to be the cutting edge of the tool. Depending on its shape, it can be classified into three categories: a straight edge, without any deviation, which provides no information about laterality, and two types of deviated straight edges, which do provide evidence.

The importance of the study of handedness in post-paleolithic prehistoric societies is to understand how the cultural factor affects to the population levels of laterality in societies formed by individuals of our own species, but with a lifestyle similar to that of the paleolithic societies formed by other human species. As we have highlighted previously, there is great variation in handedness population level throughout different cultures today, and this analysis of the laterality of the societies of the Neolithic and Chalcolithic of the Basque Country supports the theory that culture affects to the levels of handedness of a population.

### 3.2.1 Introduction and etnoarchaeologic background

The works focused on the study of the laterality in the past societies are abundant, however, there are no published studies about how to infer handedness from polished tools. Therefore, in this case, we have designed a pioneering method to infer the handedness of the

author of a polished axe. To design this method, we have carried out numerous trials and polishing sessions with different subjects. After a comparative analysis of ethno-archaeological data about human groups who made this kind of tool until recent times, or still make them, an experimental programme was designed to determine which characteristics of the tools indicate the laterality of its maker. The main morphological element susceptible of displaying a relationship appears to be the cutting edge of the tool. Depending on its shape, it can be classified into three categories: a straight edge, without any deviation, which provides no information about laterality, and two types of deviated straight edges, which do provide evidence. Subsequently, we have designed an experimental program to corroborate our hypothesis and establish under what conditions the two observed variables are related. After this experiment we have designed a method that allows us infer the laterality of the producer from archaeological materials.

In 1990, Nicholas Toth, Desmond Clark and Giancarlo Ligabue carried out an ethno-archaeological study of a group of horticulturalists of the Langda people, in the central mountains of Irian Jaya, in the west of New Guinea. This group had lived in almost total isolation until Gunter Konrad and Giancarlo Ligabue came into contact with them in 1984. The Langda, who make stone axes, live at about 2000 m altitude in the central range of New Guinea. In order to build agricultural terraces on the mountainsides, they often have to cut down trees and dig up the roots, which they do with stone axes (Stout, 2002; Toth et al., 1992).

Making polished axes is a practice that is passed from parents to children, who learn the traditional way, through long periods of practice. In addition, it give a high rank to expert men. According to Toth et al. (1992), nowadays every Langda man has at least two polished axes, and women one.

To obtain the raw material they make the axes with, the Langda go 800 m down the mountain to the River Hei. They extract flakes from large andesite cobblestones or directly use smaller stones with the right proportions for an axe: 24 cm long, 14 cm wide and 7 cm

thick. In the first roughing-out stage, they remove part of the raw material to obtain a coarse bifacial blank with a denticulate appearance and an irregular, sinuous edge. The preform is worked to reduce the angle of the edge and achieve an increasingly thin, narrow and symmetric shape. The result is a long thin axe with nearly parallel sides and a triangular cross-section about 20 cm long, 4 cm wide and 3 cm thick (Toth et al., 1992). They then sharpen the edge. This is the phase in which, in accordance with the hypothesis of the present study, the maker's laterality will be reflected. According to Toth et al. (1992), the artisan works near a source of water, crouches behind the grindstone, pours water on its worn surface and sharpens the axe on it. During this process, great care is taken with the edge, attempting to keep it straight with no deviation. However, owing to the position of the arm relative to the grindstone and the circular action made by the hand-arm-shoulder system, the edge may deviate, indicating the laterality of the maker, as explained below. Finally, after the whole surface of the axe has been ground, the artisans haft the axe on a T-shaped piece of wood. In this way, Toth et al. divide the work of making the axe into three stages (without taking into account the procurement of the raw material and the hafting): roughing out, fine knapping or chipping and grinding. They do not include a final polishing stage, which only alters the aesthetic appearance of the axe, without affecting its functionality at all.

Based on these ethnographic studies and other previous research on the manufacture of ground stone axes (Mazo and Rodanés, 1986; Valdés, 1981), it may be concluded that the chaîne opératoire with which they are made consists of four main stages: roughing out, chipping, grinding and polishing. In the roughing-out stage (Figure 3.1 A), the raw material is reduced in size by bifacial knapping, until the approximate shape of the finished



Figura 3.1 Chaîne opératoire of an polished axe (After Acosta García 2008).

axe is obtained. The knapping is normally by direct percussion with a hard hammerstone, although the raw material is probably chosen with a suitable shape to minimize the work in this stage (Rostain, 1990). As observed in the archaeological record, axes are often made from cobblestones (Ormazabal et al., 1994; Rostain, 1990). Tribes who still make ground stone axes, like the Langda in Irian Jaya, also use this resource (Toth et al., 1992). Once the preform has been obtained, the small irregularities produced during the roughing-out stage are eliminated by chipping the axe (Figure 3.1 B). This also produces a rough surface which means the next abrading or grinding phase can be carried out more rapidly (Rostain, 1990). It is usually performed by hitting the surface of the axe directly with a hammerstone. When this phase is finished, the axe has a similar size and shape to the final result but still does not possess a sharp edge. If a cobble is used as the original raw material, this phase may be much shorter, as the irregularities will be very small. To sharpen the edge and create a final shape suitable for hafting, abrasion or grinding is used (Figure 3.1 C). This technique consists of grinding the axe with an abrasive static grindstone, usually of sandstone. It is normally carried out with water, which is poured over the grindstone, sometimes mixed with clay. The presence of water lubricates and helps the evacuation of the residue produced by grinding (Harding, 1983). Many grinding workshops in the French Guyana are located near the shore or watercourses (Kozak et al., 1979; Rostain, 1990). The last phase, which does not modify the shape of the axe substantially, is polishing (Figure 3.1 D). This gives the tool its finished appearance and consists of gentle polishing with less abrasive elements to achieve the final shiny and smooth result. During the grinding phase, the grindstone is placed on the ground in front of the artisan, who squats with the grindstone between his legs (Toth et al., 1992).

### 3.2.2 Experimental programme

According to the observations made during the initial phase, we believe that the element of the axes, susceptible to be related to the laterality of the producer, is the cutting edge. Understanding the *chaîne opératoire* and the preliminary experiences in grinding axes have allowed us to perform experiments that are detailed on this section. Subsequently, based on

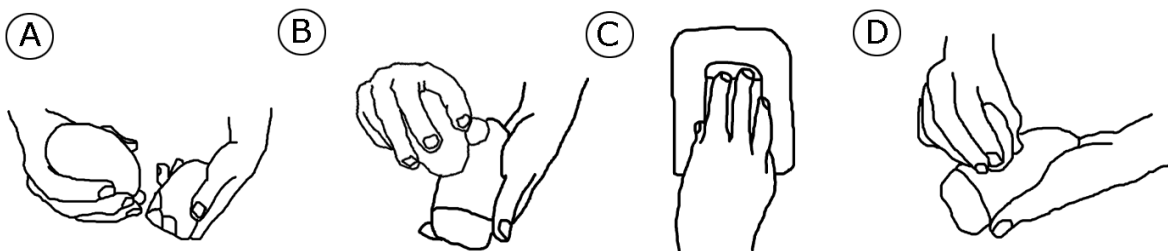
the results of this experiment, we will develop a specific method for this type of tools.

### 3.2.2.1 Materials

In the Neolithic and Chalcolithic, the choice of raw material depended on knowledge and access to outcrops of suitable materials (Jimenez-Guijarro, 2010). In this case, through the study of the raw materials in the archaeological assemblages from Urrunaga Reservoir and Dehesa de San Bartolomé (Álava), it was determined that many of these tools are made from sub-volcanic or volcanic rocks: ophites and basalt with variable grain size (Fernández Eraso et al., 2003). Metamorphic rocks like sillimanite and fibrolite (Ormazabal et al., 1994) and, in the case of Pico Ramos Cave, quartzite (Zapata, 1995) were also used. To make this type of tool, the abrasion must be regular, so it is important that the raw material is homogeneous (Rostain, 1990). Accordingly, ophite and basalt were used as the main raw materials to make the experimental axes. These raw materials are some of the most abundant in the archaeological assemblages in Álava and Bizkaia studied in this research programme (Estavillo, 1975; Fernández Eraso et al., 2003; Ormazabal et al., 1994). The basalt used for the experimentation comes from an outcrop in Meñakoz, Bizkaia. It is interbedded between shale and its external appearance is very irregular (Castañares et al., 1997). The outcrop is on the shore, and the wave action has formed numerous cobblestones in the basalt that have been deposited on the beach. The ophite comes from Pico Midi d'Ossau in the Pyrenees. As the raw material used for the experimentation is in the form of cobbles, the preparation phase was practically unnecessary. However, cobblestones with an appropriate shape must be chosen. Other tools were made from roughed-out raw material and it was seen that the choice of one or other preform does not influence the study of edge morphology.

For the grindstone, it is necessary to use a material whose hardness and abrasive capacity are greater than the material being ground (Semenov, 1964). According to documentation on modern tribes who make axes (Toth et al., 1992) and data obtained from the archaeological record (Rostain, 1990), the grindstone is usually made of sandstone, with an average size (30 cm in diameter). In this case, a fragment of siliceous sedimentary cobblestone, with



Figura 3.2 Grindstone used during the experimentation.

medium-sized grain, was used. It is classified as micro-conglomerate and was collected in the same coastal environment as the Meñakoz basalt. Its dimensions are 215 milimeter long, 105 milimeter wide and has a maximum thickness of 90 milimeter (Figure 3.2).

#### 3.2.2.2 Individuals

Two right-handed and two left-handed grinders took part in this experiment, using the types of raw materials described above: basalt, ophite and schist. Table 3.1 shows the relationships between the tools made, the raw materials and their manufacturers.

<b>Reference</b>	<b>Maker's laterality</b>	<b>Raw material type</b>
E0	Right-handed	Basalt
E1	Right-handed	Basalt
Ed3	Right-handed	Ophite
As1	Left-handed	Basalt
As2	Left-handed	Basalt
B1	Left-handed	Schist

Table 3.1 List of experimental axes, laterality of the authors and the type of raw material.



### 3.2.2.3 Procedure

Several grinding sessions were held, with the participation of the four individuals using the described materials. In these sessions, the individuals squatted in front of the grindstone (Figure 3.3), emulating the Langda axe makers and abraded the preforms against its surface. To facilitate the abrasions, the axe and grindstone were lubricated with water. After an average of two hours grinding, divided into four sessions, a perfectly functional edge was obtained. In one of the cases, the toolmaker knapped a given flake to get an axe-like preform. In the other cases, the tool was made from a pebble. All of the toolmakers had to polish the preform until they got an edge.

The cutting edge is constructed by the intersection of two polished planes. At one of the sides of the preform two planes are polished, one for each side of the axe, converging together. As we polish the stone axe, the surface of these planes increases until the two planes intersect one with the other creating an edge.



Figura 3.3 A subject polishing during the experimentation.

To document the experiment, the tools were photographed and measured at different stages in their manufacture, in order to study the way in which they evolved. In Annex X they have been compiled different photographs of each polishing phase and the tipometric measures taken at all times.

To document the experiment, the tools were photographed and measured at different stages in their manufacture, in order to study the way in which they evolved. In

Annex X they have been compiled different photographs of each polishing phase and the tipometric measures taken at all times.

### 3.2.3 Application of the method

The representation system developed by Ormazabal et al. (1994) was used to study the axes:

*“it will be placed in a longitudinal direction as if it were inscribed within an orthogonal prism consisting of two horizontal planes (upper face A and lower face A’), two sagittal norms (dextra face B and sinistra face B’) and two transversal norms (distal face C and proximal face C’) (Figure 3.4). In turn, within each of these faces, three zones are differentiated following the sagittal axis (distal, medial and proximal) and a further three following the transversal axis (dextral, medial and sinistral).”*

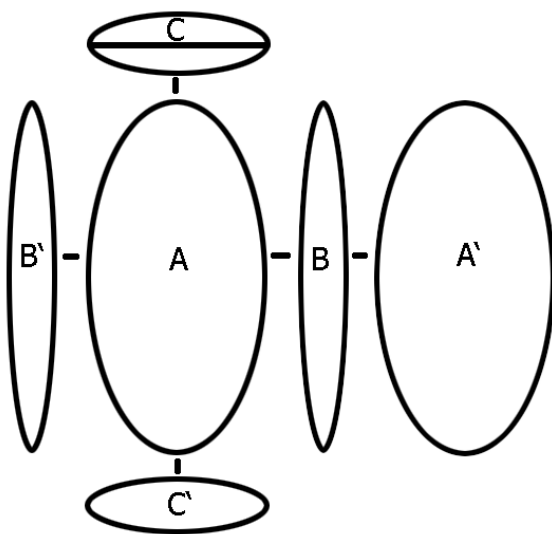

Figure 3.4 Nomenclature of the different views of an ax. (After Ormazabal et al., 1994).

According to the analytical typology for ground axes, defined by A. Fandos, the edge is the active part consisting of a line defined by a transversal bevel at one end of the axe. This scholar defines three bevel types: (a) formed by the intersection of two faces; (b) formed by the intersection of a face and a bevelled plane; and (c) formed by the intersection of two bevelled planes (Fandos, 1973). Ground axes, depending on the shape of the edge profile, seen from the front (Face C), can be classed in three categories: straight edge



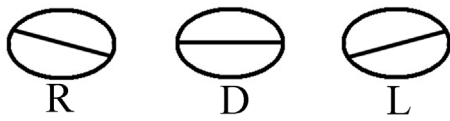

Figure 3.5 Schematic representation of the three types of edge: R (associated with a right-handed), L (associated with a left-handed) and D (straight without diverting).

with no deviation (D) and two types of deviated straight edges (R and L; Figure 3.5). In principal, the toolmaker will attempt to grind a straight edge, seen from the front (Face C), which is not deviated. Consequently, most archaeological ground stone axes studied here display a straight, non-deviated edge. The

preference for this type of edge must be due to functional or aesthetic reasons. However, there are some axes where, perhaps because of the maker's inexperience, the straight edge is deviated. In the studied archaeological record there is a significantly higher number of axes whose edge is biased in a clockwise direction, that axe whose blade is deviated in the counterclockwise direction, the court observed from the front (Face C).

To perform the friction phase, in which the edge takes its final shape, the producer must wear away the surface of the preform at one end. The aim is to obtain a sharp wedge, for that purpose the individual must create at least two polished surfaces, one for each side (side A and A'), which an acute angle between them, so that the intersection between both is the axe's blade.

In case we use only one grinding plane for each face (A and A'), the profile of the cutting edge, seen from A or A', it will be rectilinear, if we use a flat beveled, meaning several polished planes by each side (A and A'), the result is a convex delineation of the cutting edge, seen from A or A'. To analyze the laterality of the polisher must analyze each plane individually, so the axes suitable for this study are those whose edge has

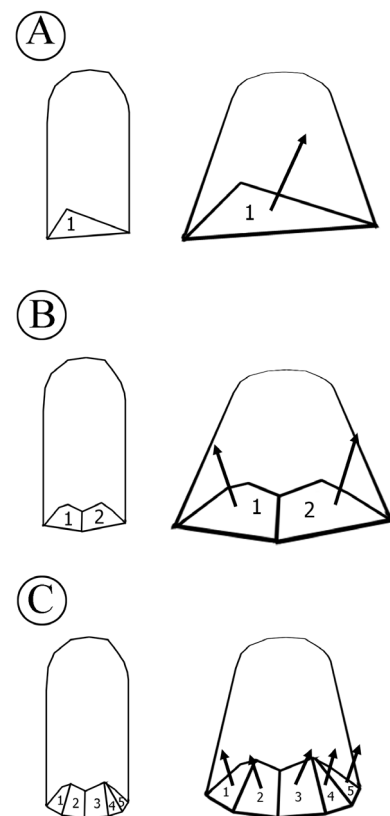

Figure 3.6 Polished planes and orthogonal vectors to these planes. Single polished plane (A), two polished planes (B) and several polished planes (C).

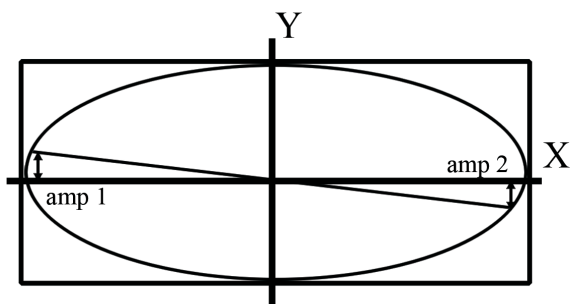

Figure 3.7 Cross section of an axe seen from his face C where the elements described in the cutting edge are represented: amplitude 1 (Amp1), amplitude 2 (Amp2).

In the first place, the Face C is placed inside the rectangular parallelogram that best fits its size. It does not matter which of the two faces is defined as A or A', nor which is placed above or below. A system of Cartesian coordinates is established inside, where the X axis is perpendicular to the small sides of the quadrilateral, and the Y axis is perpendicular to the long sides and equidistant from the small sides (Figure 3.7). The intersection point between the profile of the cut and the "x axis" is arbitrarily placed to the right of the origin of coordinates and is defined as the distance that separates it from the x axis (in the case of match with the coordinate origin is placed on the origin of coordinates). Amplitude 1 (or Amp1) is defined arbitrarily as the one on the right of the Y axis and Amplitude 2 (Amp2) as the one on the left. The amplitude is measured as the maximum distance of the cutting edge from the X axis, measured perpendicularly to it. The amplitudes on the positive side of the

been made by the intersection of two polished planes, one on each side; by the intersection of a polished plane on one side and a beveled plane in the other; or at least an axe which the central part of the cutting edge has been prepared in this way (Figure 3.6).

Despite the ease in assigning an edge to one category or another, a procedure was developed to systemize their classification. In

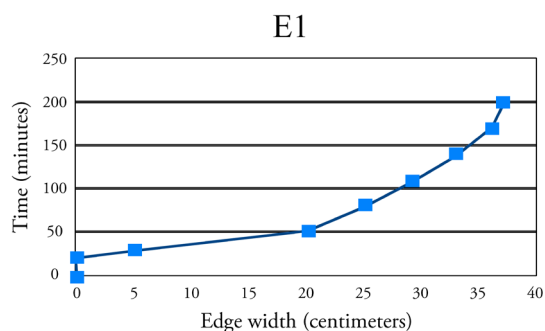
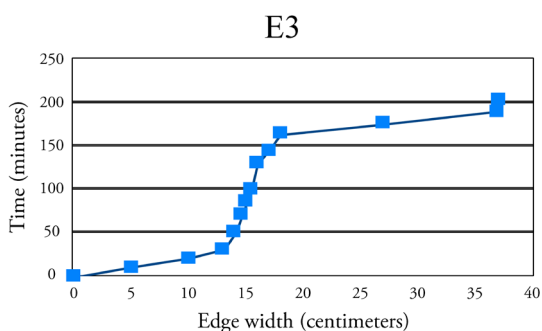

Figure 3.8 The relationship between polishing time and the width of the cutting edge of the experimental axe E3 and E1.

Y axis are positive, while those on the negative side are negative. Not all the edges display a development of both amplitudes. A Type R edge is defined as one whose Amp1 is positive and/or its Amp2 is negative. A Type L edge is defined as one whose Amp1 is negative and/or its Amp2 is positive. A Type D edge is one with neither of the two amplitudes. These measurements have been taken from a frontal picture of the Face C, using the “ruler tool” of the Adobe Photoshop CS.

Figure 3.8 represents the evolution of the cutting edge of E3 axe and E1 axe (Figure 3.8) during the experimentation. It is appreciated that the evolution of the edge length in both cases followed a very different pattern. For E1, the cutting edge increased in size gradually, as the axe was being polished, to have the final 37 mm of length after 200 minutes of polishing. In the case of E3, the size of the cutting edge increases very dramatically around 150 minutes of grinding, so that in just 50 minutes of polishing the cutting edge increases its size from 15 mm to 37 mm after 200 minutes of polishing. In the case of E3 axe, between 40 and 150 minutes of polishing, the cutting edge length increases only 5 mm. This difference is due mainly to the initial morphology of the pre-form, before polishing. The case of E1 axe, the pre-form was a cobble. The shape of the area where the cutting edge is polished was rounded and fairly regular. This caused that the cutting edge increases its size very gradually. However, the E3 axe was made from a flake. The end of the axe where the cutting edge was made, in this case, was not rounded and had an initial flattened relatively irregular morphology. The initial shape of the preform, in this case, is closer to the final shape of the cutting edge. This caused that, until the 150 minutes of grinding, the cutting edge did not manifest the effects of the abrasion. When the two polished planes finally join, they were practically developed, and the cutting edge length was increasing with relatively little polishing time. However, because the dimensions of width and maximum thickness the cobble and the knapped pre-form, in this case, are very similar (Table 3.2), we get the final cutting edge of 37 mm around 200 minutes of polishing in both cases. Therefore, when choosing the pre-forms from which we will make the experimental axes, we have chosen cobble whose shapes are close to a knapped pre-form with a maximum thickness less than the width.

<b>Reference</b>	<b>Maximum width</b>	<b>Maximum thickness</b>
E1	62	34
E3	60	24

Table 3.2 Initial measures of the preform from which the E1 and E3 axes were developed.

### 3.2.4 Experimental results

During the experiment, six axes were made following the methodology described above. The axes were then classified according to the type of edge (R, L or D) (Table 3.3; Figure 3.5); and other descriptive measures has been taken (Table 3.3). E0, E1, AS1, AS2 and B1 were made from a cobble, while Ed3 was made from a knapped pre-form.

During the process of making the polished axes, some have been measured and photographed every 10-20 minutes of polishing. The measures we have taken are the length (measured from the cut to the proximal part of the axe), the maximum width (measured perpendicular to the length and in the same direction of the cut) and the maximum thickness (measured perpendicularly to the width). This allowed us to observe that, as we polish the edge, the two planes whose intersection would result in the cutting edge, they passed gradually from a horizontal position to a markedly deviant one.

<b>Reference</b>	E0	<b>Length</b>	122 mm
<b>Width</b>	76 mm	<b>Maximum thickness</b>	53 mm
<b>Raw material</b>	Basalt	<b>Cutting edge width</b>	56 mm
<b>Maker's laterality</b>	RH	<b>Edge type</b>	R

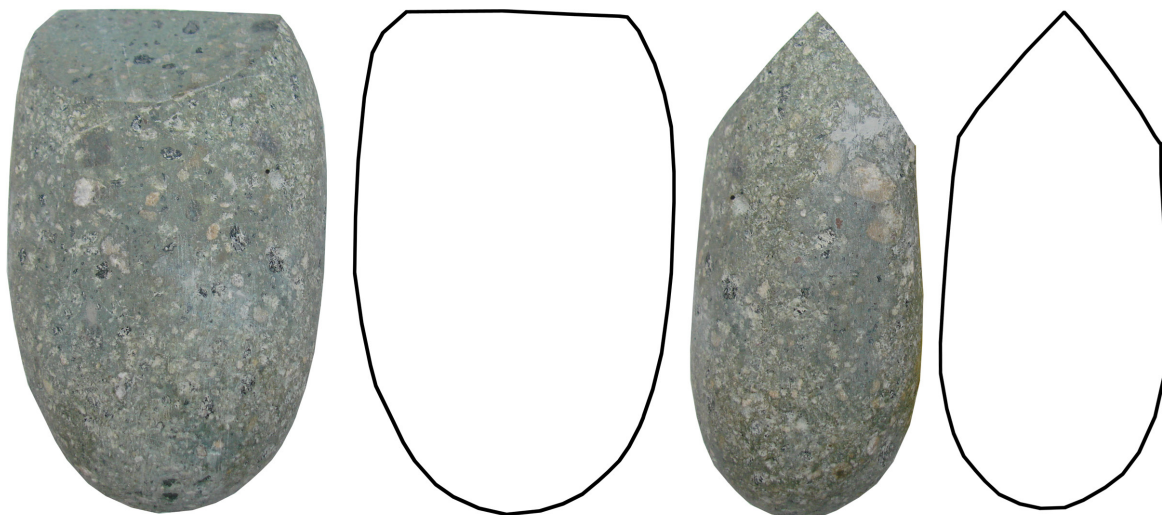

20 mm

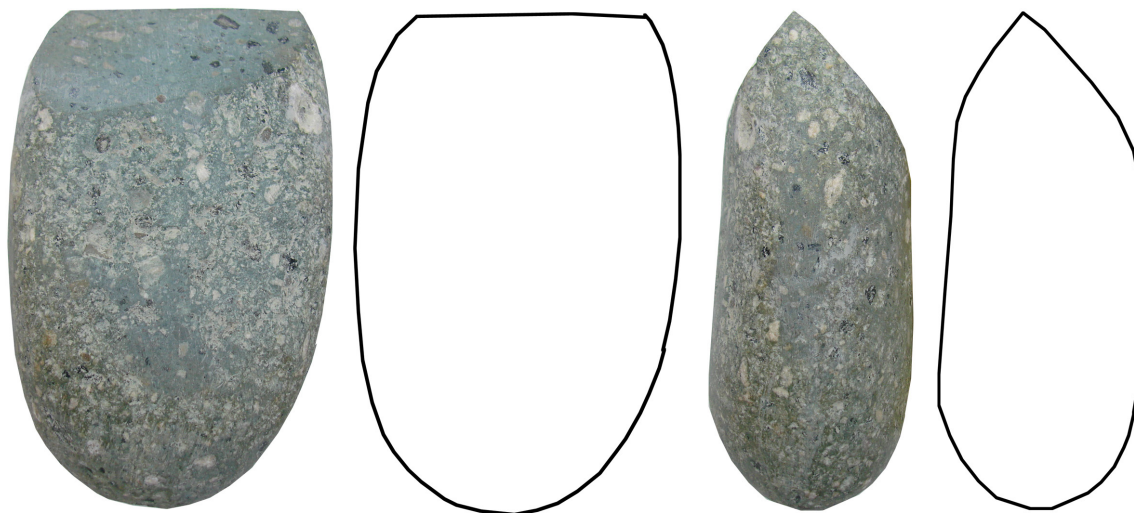

20 mm

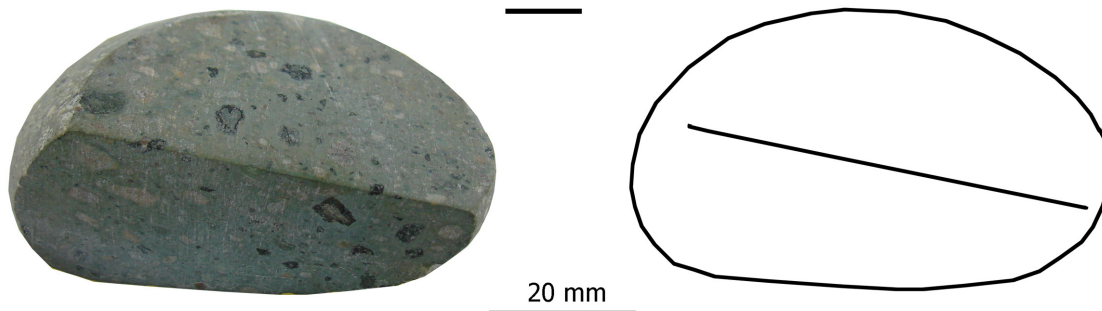

20 mm



<b>Reference</b>	E1	<b>Length</b>	84 mm
<b>Width</b>	62 mm	<b>Maximum thickness</b>	34 mm
<b>Raw material</b>	Basalt	<b>Cutting edge width</b>	37 mm
<b>Maker's laterality</b>	RH	<b>Edge type</b>	R

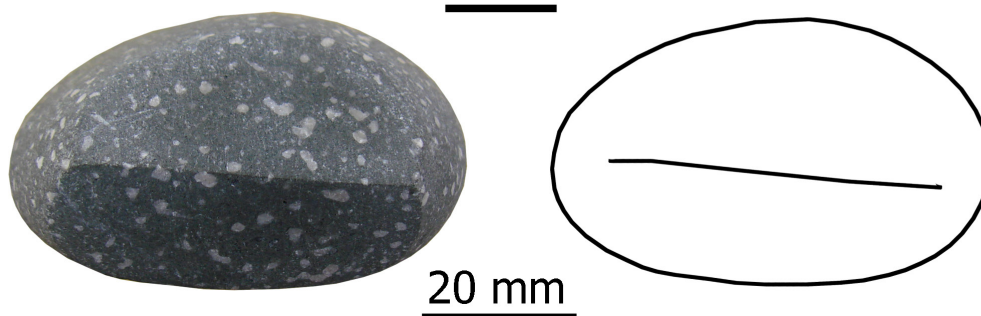
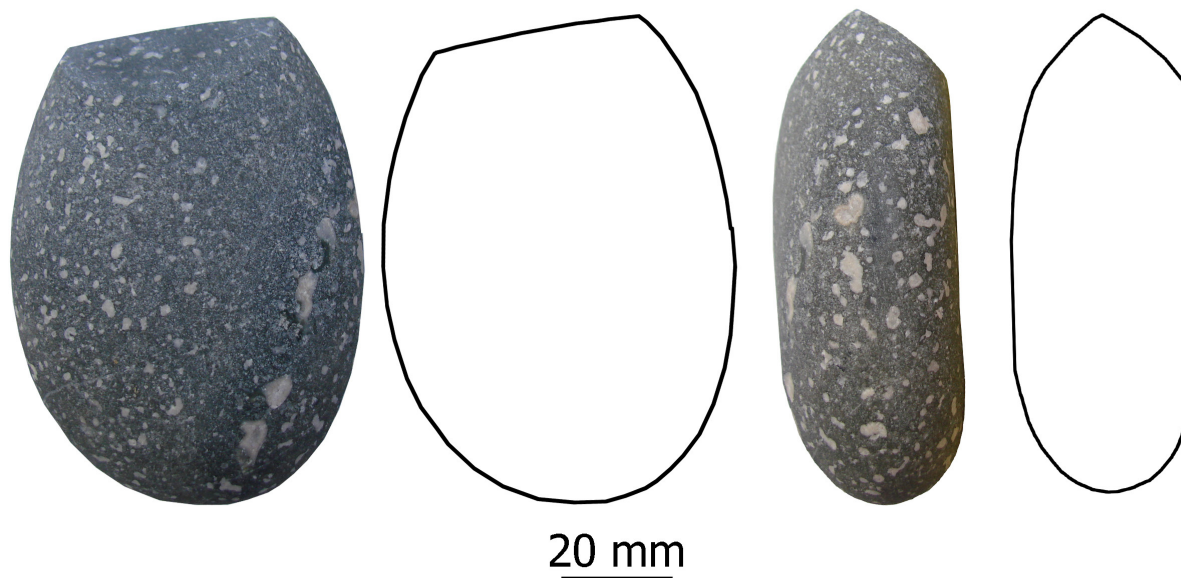
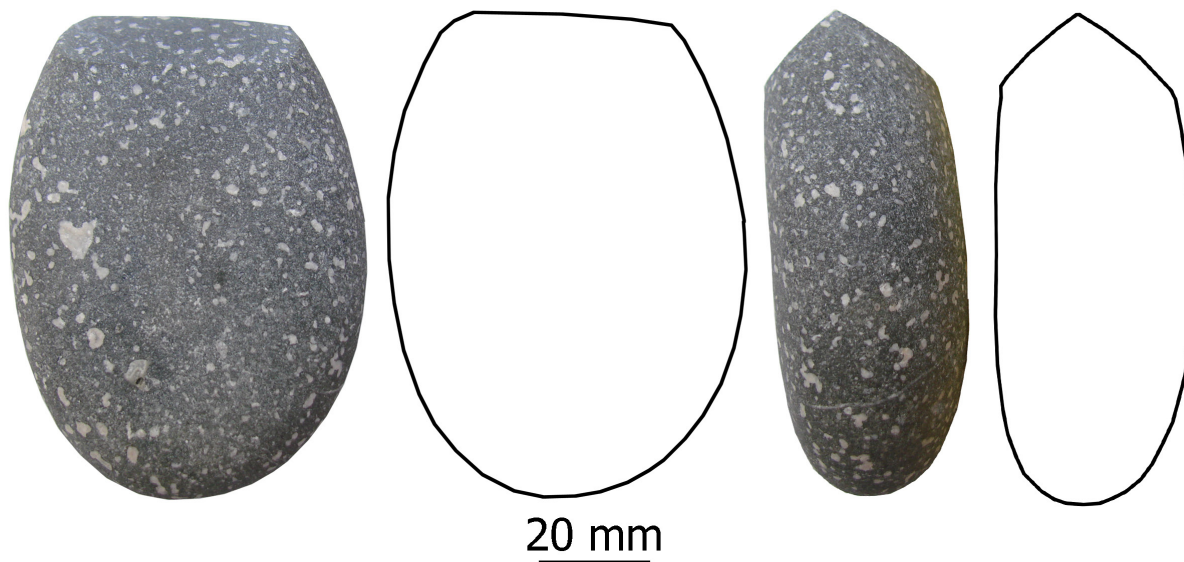

<b>Reference</b>	Ed3	<b>Length</b>	142 mm
<b>Width</b>	60 mm	<b>Maximum thickness</b>	37 mm
<b>Raw material</b>	Ophite	<b>Cutting edge width</b>	24 mm
<b>Maker's laterality</b>	RH	<b>Edge type</b>	R

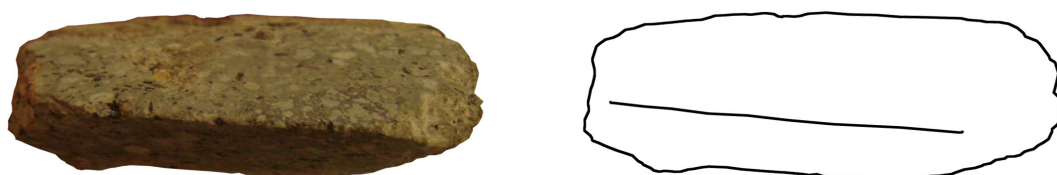
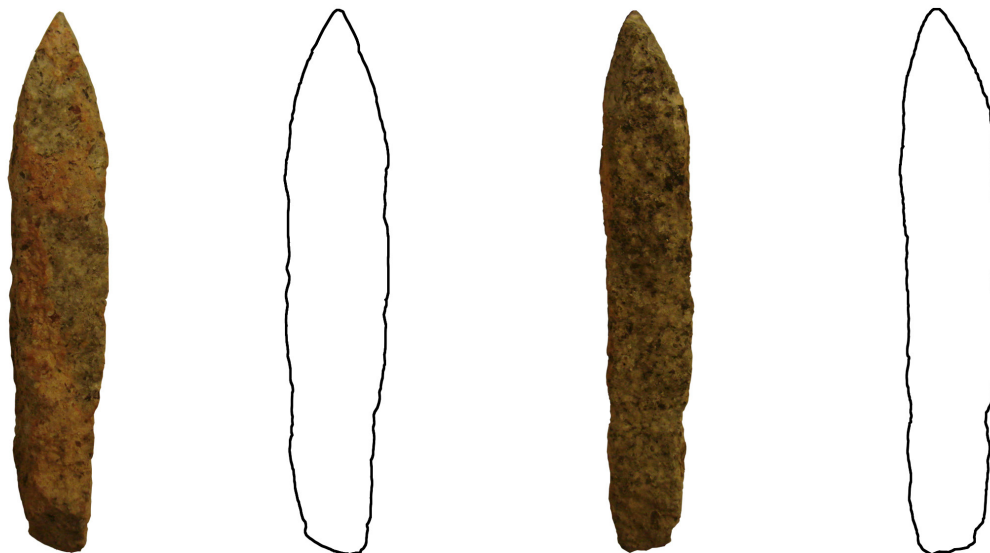
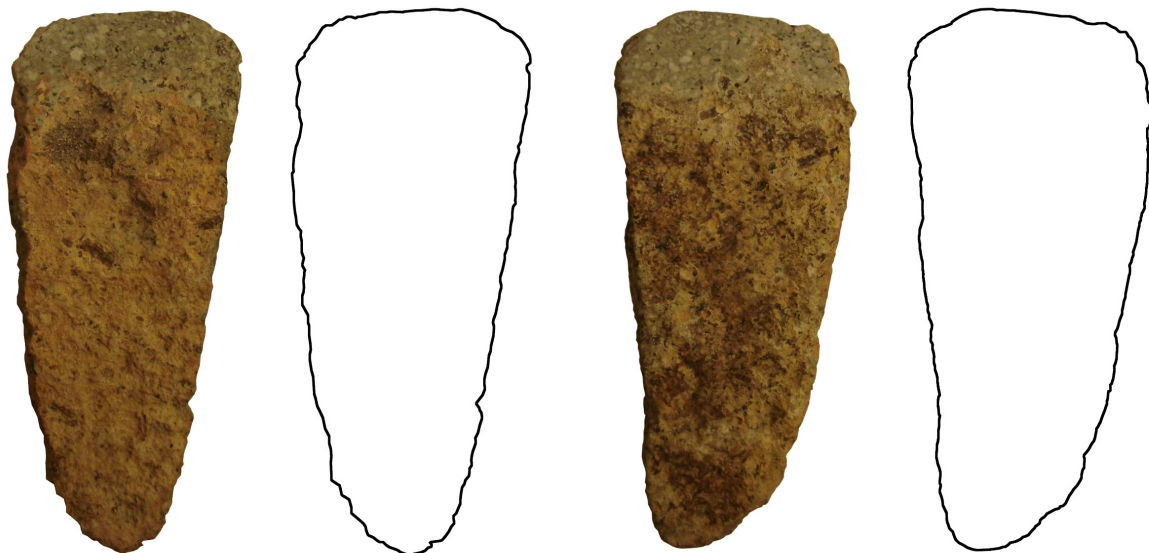

<b>Reference</b>	As1/As2	<b>Length</b>	99 mm
<b>Width</b>	76 mm	<b>Maximum thickness</b>	46 mm
<b>Raw material</b>	Basalt	<b>Cutting edge width</b>	29 mm / 20 mm
<b>Maker's laterality</b>	LH/LH	<b>Edge type</b>	L/L

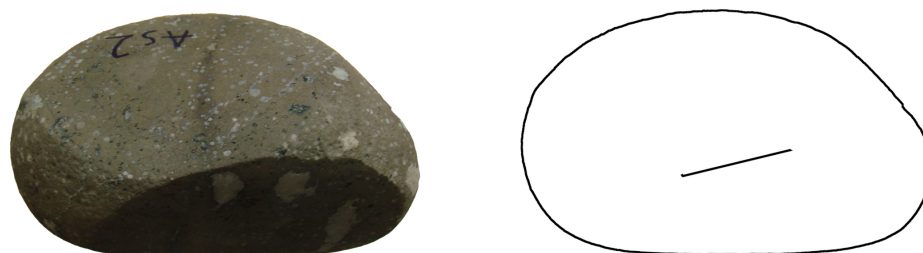
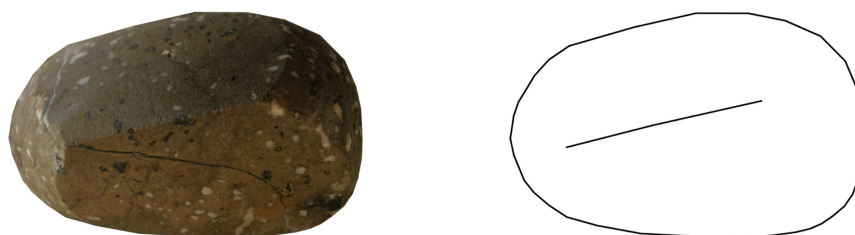
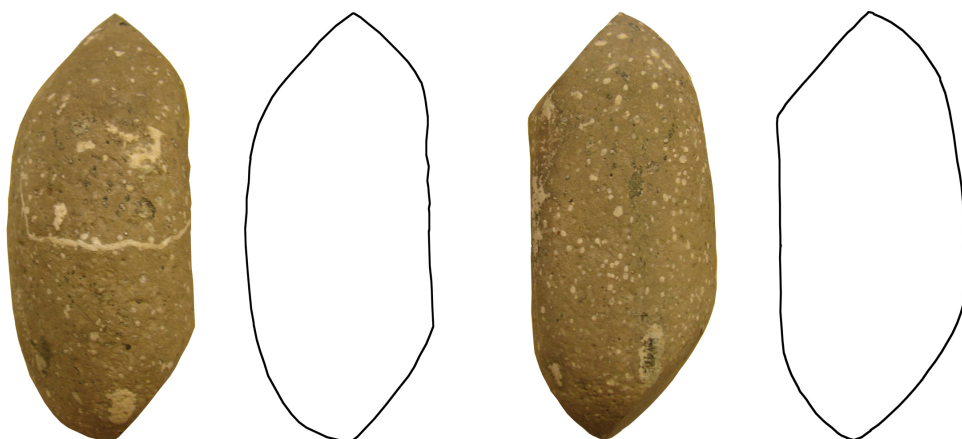



<b>Reference</b>	B1	<b>Length</b>	99 mm
<b>Width</b>	43 mm	<b>Maximum thickness</b>	20 mm
<b>Raw material</b>	Schist	<b>Cutting edge width</b>	13 mm
<b>Maker's laterality</b>	LH	<b>Edge type</b>	L

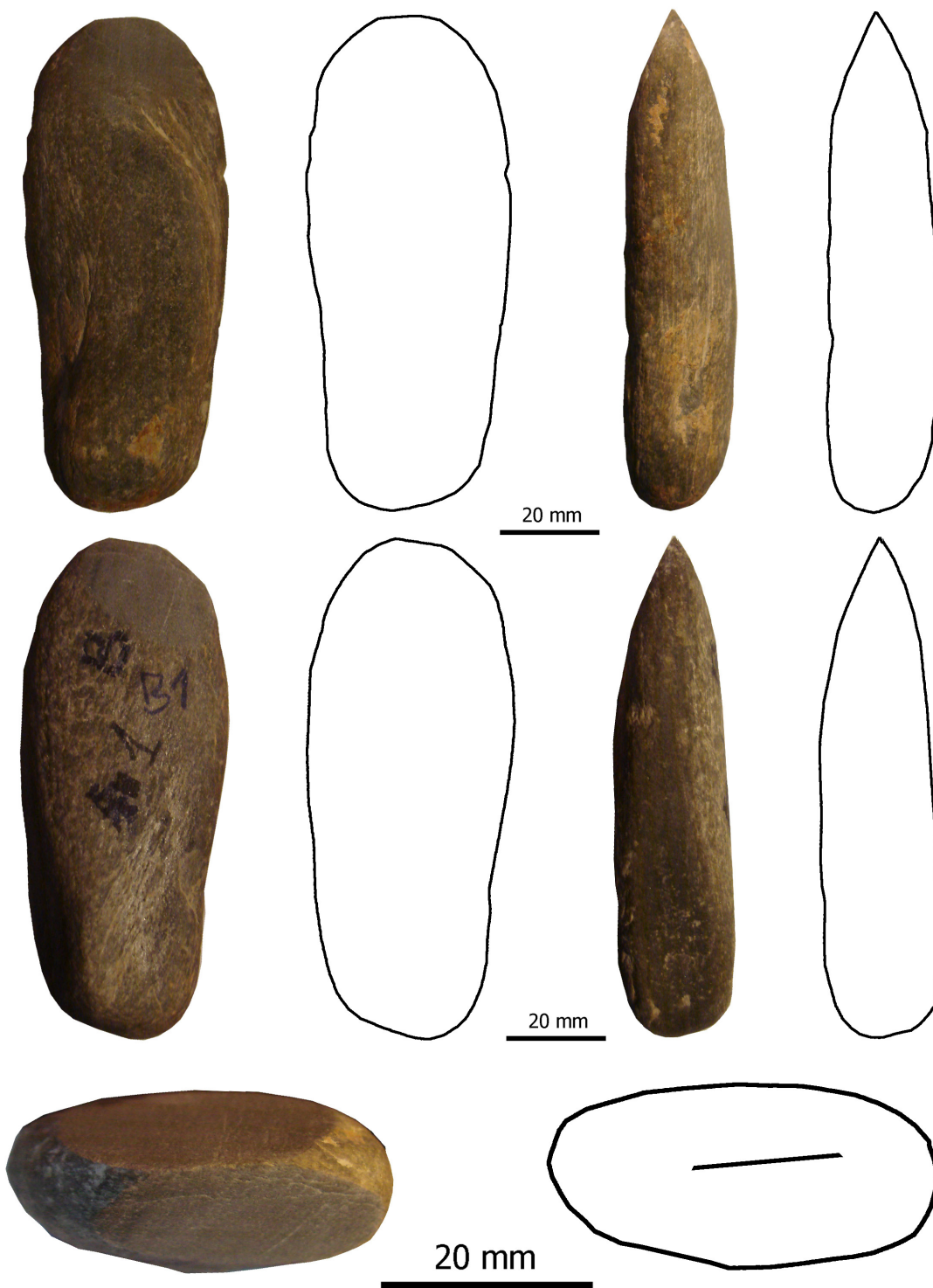

Table 3.3 (Previous pages) Descriptive measures and photographs of each of the faces of the experimental axes.

In Annex I initial, intermediate and final stages of the experimental axes are illustrated by photographs of each of the faces of the axe. Descriptive measures for each moment are also detailed.

### 3.2.5 Discussion of the results

As mentioned above, based on the studies of the Langda, the grindstone is placed on the ground in front of the artisan who crouches with the stone between his legs (Toth et al., 1992). In the case of a right-handed individual, the stone to be ground is held in his right-hand, and using the whole right hand-arm-shoulder system, the tool is shaped by grinding it on the sandstone. Although the left arm and hand may be used, it is always as a secondary support and the right-hand does all the work of guiding the axe. In the case of a left-handed

person, the process is similar but inverse. (fig. 3.3).

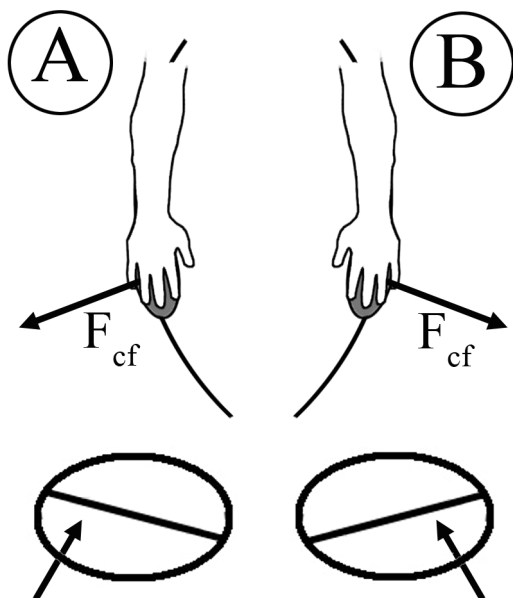

Figure 3.9 Schematic representation of the circular trajectory of an of a right-handed (A) and a left-handed (B) and the centrifugal force ( $F_{CF}$ ) (above). View of the profile of the cutting edge showing the application of the maximum abrasion (below).

The arm holding the tool moves in a circumference by pivoting around the shoulder. This circular movement involves a centrifugal force which means that the axe is abraded more on the one side (Figure 3.9). The spatial relationship between the centrifugal force and the axe is analogous whether the grinder is right-handed (A) or left-handed (B) but in the opposite direction. These grinding conditions create an equivalent deviation of the edge, but an opposing one, depending on whether the artisan is right-han-

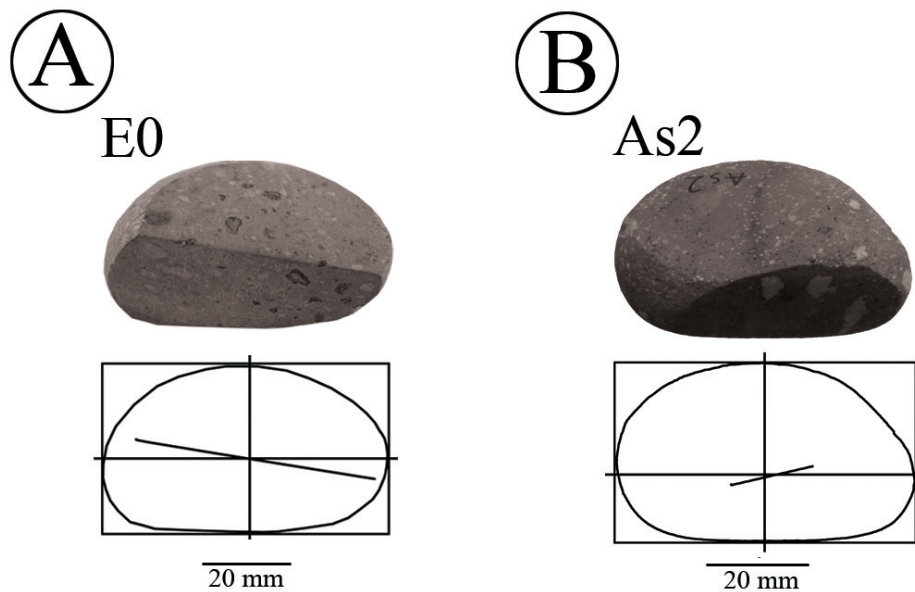

Figure 3.10 Examples of axes produced in the experimental programme with the edge deviated towards the right (A) and left (B).

ded (Figure 3.10 A) or left-handed (Figure 3.10 B). According to this process, the edges have been divided into three categories: non-deviated edge (D), edge deviated to the right (R) and edge deviated to the left (L).

Observation of the evolution in the edge shape, during the grinding process, shows that at all times, the axe is ground more intensely on its external side, which is the side on the outside of the circle made by the grinding arm.

According to the experimentation results, we can associate the edge shape with the laterality of the axe maker. The centrifugal force created when the stone is ground on the grindstone, due to the pivoting action of the arm around the shoulder, causes a differential wear on the abrasion surface of the axe. This differential wear is in opposite directions, depending on whether the axe maker is right-handed or left-handed, producing two edge shapes. These two shapes consist of two kinds of straight edges with an analogous deviation, in opposite directions depending on whether they are made by a right-handed or left-handed person. In 60% of the archaeological objects, this differential abrasion does not occur or its effect is imperceptible, producing a non-deviated straight edge. These edges provide no information

about the laterality of the grinder. We explain the absence of these non-significant shapes in our experimental programme to the limited experience in the modern ways of making ground axes and the thickness of the preform when it is ground. The thicker it is, the more time is needed to grind the edge, and consequently the forces that cause greater abrasion on the one side are acting for longer. It has been determined that axes whose preforms are made from cobbles with an initial thickness of 3–5 cm suffer more deviation on their edges than axes made from thinner preforms or cobbles less than 3 cm thick. With experience, the effect can be controlled and straight edges produced whatever the initial thickness.

Analyzing the results, we can conclude that the handedness has influence in the final shape of the cutting edge of an axe. However, there are other unknown factors that can influence in the final form and which are not related to handedness. Still, we believe that the handedness of the producer is the main factor, and the difference between R type and L type cutting edges observed in the prehistoric tools effectively respond to this phenomenon. However, as mentioned above, the nature of the task influences in the handedness we measure, so one person can be more lateralized to perform the task of writing than to perform the task of grinding an axe. Therefore, we have to be careful when comparing levels of laterality measured from the task of polishing axes with current levels of laterality measured from different tasks, such as the task of writing. If we want to make a reliable comparison between the laterality measured from grinding an axe and the current laterality, we must find a task that is performed by individuals today, and involving similar complexity, such as the task of washing dishes or washing clothes by hand. In this case, as detailed below, we have chosen to compare these results with those obtained in non-industrialized societies, where laterality levels were measured by tasks like throwing objects.

### **3.3 Laterality through the flakes**

Lateralised human behaviour may be reflected in the products of technological activity, and particularly in artefacts made by hand (Uomini, 2011). Lithic reduction, which our genus has performed since the first stages in its evolution, has formed large assemblages,

which are usually well-conserved and a potential source of information for a diachronic study of the handedness process in different human species. Since the late twentieth century, following N. Toth's research (1985), there has been growing interest in obtaining data about handedness through the lithic record. Rugg and Mullane's study (2011) represented significant progress in the analysis of lithic assemblages from the point of view of handedness, and more recently Bargalló and Mosquera (2013) developed a method by which the handedness of a particular knapper can be determined by refitting the flakes extracted from the core. However, these methods involve requirements that are very difficult to fulfil in a large sample from any assemblage, because it is difficult to find many refittings. In other words, to obtain extensive results susceptible to relevant statistical tests, even from not especially large assemblages, we need to identify and assess a trait indicating the knapper's handedness that can be easily found in prehistoric artefacts. This is the objective of the present study.

### 3.3.1 Previous studies

The first studies aiming at determining handedness from flakes were carried out by Toth in 1985. The researcher's conclusions were based on the hypothesis that handedness influences the direction in which the core is turned when it is being reduced. According to Toth, a right-handed knapper will turn the core towards the right as flakes are extracted. When the cortex is being removed from the core, this will tend to produce flakes with the cortex on their right side, whereas if the knapper is left-handed, the opposite effect will result. However, later experimental work (Patterson and Sollberger, 1986) found that the geometric shape of the core is decisive in the type of flakes and that a left-handed knapper may produce a certain number of right-handed flakes, and vice versa. In the experiment, Sollberg produced 56 % right-handed flakes (according to Toth's terminology) despite being left-handed. In a study carried out by Pobiner (1999) with seven right-handed students at the University of Pennsylvania, 284 flakes were produced in a number of knapping sessions. It was found that as the number of flakes increased, the ratio of right-handed/ left-handed flakes approached 50:50. Therefore, Toth's method can only be applied to a specific reduction strategy in which flakes are extracted from the same platform following a certain sequence.

It would be important therefore to find a method that is not based on knapping habits by proposing hypotheses based on elements directly related to percussion, such as the angle and direction of the blow from the hammerstone on the percussion platform. In this line, Rugg and Mullane (2001) studied the orientation of the cone of percussion in the flake, as this is conditioned by the direction of the angle of blow. In their experiment they examined 299 flakes, of which 75 were considered valid to determine the knapper's handedness. With this restricted assemblage, they claimed they were able to determine the handedness correctly in 75% of the cases. However, it was recently shown (Bargalló and Mosquera, 2013) that Rugg and Mullane's method alone is unable to determine the knapper's handedness. By examining the cone of percussion and other characteristics in the flakes, they developed a system to determine the knapper's handedness from several flakes extracted by the same individual. However, this method is not applicable to each particular flake in a large assemblage and is, therefore, limited to the study of lithic refits. Unfortunately most lithic assemblages cannot be refitted, and consequently it is necessary to find a method allowing the determination of the knapper's handedness, with a reasonable level of certainty, even from a single flake.

In the present section we describe a method enabling each flake to be associated with the handedness of the knapper who extracted it, without needing several flakes removed by the same knapper, which is a requirement that is nearly always difficult to fulfil. This means it is an extensive method that can be applied in different periods in the archaeological record. It is based on a characteristic of the mechanics of the conical fracturing of flint that can often be seen on flakes, which means that it can be applied widely. The main limiting factor of this method is that it is still not known whether it is applicable to the reduction of other raw materials, like quartzite, obsidian and basalt, and in these cases, the experimental protocol followed in this study of flint would have to be applied.

Clarkson (2007) in his book "Lithics in the Land of the Lightning Brothers: The Archaeology of Wardaman Country, Northern Territory" thus describes the knapping process and the formation of the Hertzian cone:



*«In most forms of flaking, force is directed into the platform (i.e. any surface receiving force) of a nucleus with an indenter (any object imparting force to a nucleus) (...) striking the nucleus at high velocity with either a hard indenter such as a hammerstone (hard hammer percussion) (...) (Cotterell and Kamminga 1987; Kooyman 2000).*

*Fracture occurs when stresses within the nucleus reach a critical threshold and break the molecular bonds holding the nucleus together. (...) The Hertzian cone propagates in a circle around the contact area and expands down into the nucleus in a cone shape at an angle partly dependant on the angle of applied force. (...) Whether or not a fracture will continue to propagate through the core once a cone is formed (i.e. and not just leave an incipient cone in the nucleus), depends on whether the force of the blow is sufficient to accelerate and overcome the inertia of the material that is to be removed. (...) In conchoidal fracture, the path will typically first head into the core before diving back toward the free face, creating the bulb of force, and then stabilizing on a path that is more or less parallel to the free surface (Macgregor 2001).»*

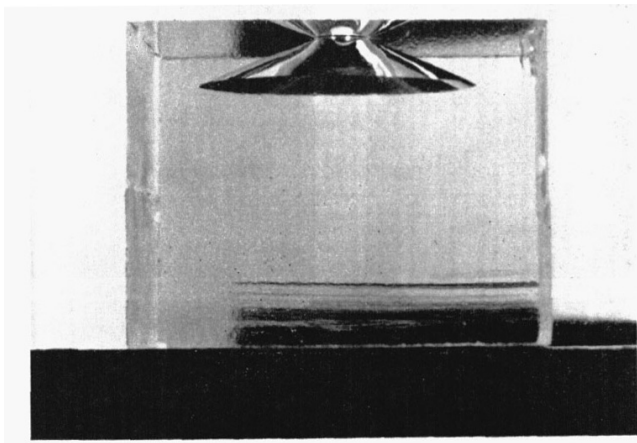

Figure 3.11 Photograph of a cone of percussion made by the impact on a glass surface. Taken from Roesler 1956.

Hertz (1882) first described the behaviour of an elastic material under the application of a force and the appearance of the conical fracture named after him. Since then, many studies have considered the forces prevailing in the fracture of several kinds of materials. Roesler (1956), based on Hertz's work (1882), described the mechanics of the conical fracture of glass in the following way "When a spherical indenter is pressed against a flat surfaced glass specimen it makes the

glass break in a ring crack around the contact area. When the pressure grows the ring crack spreads downwards, flares out and tends in shape to the mantle of a circular cone”. In his paper, he gives an ideal pattern of the conical fracture as well as real photograph illustrating a cone of percussion (Fig. 3.11). Some time later, Frank and Lawn (1967) studied Hertzian fractures again and described the main forces acting on the (semi-infinite) surface of an elastic medium. They also gave a photograph showing the result of hitting a glass surface with a steel ball. The photograph shows, on the glass surface, the “ring crack” described by Hertz (1882) and studied later by Roesler (1956) which consists of a ring-shaped fracture produced beyond the edge of the breakage of the material. Clarckson (2007):

*«Conchoidal flakes (i.e. those with Hertzian initiations) often retain a ring crack at the point of force application (PFA), and an erailure scar just below the point of percussion on the bulb of force. Undulations in the fracture path also often leave compression waves on the ventral surface of flakes. Fissures radiating out from the point of percussion are also often found on the ventral surfaces of flakes, but are most often seen on fine grained materials.»*

The bulb has a conical shape, and when the percussion is very violent (it is required to exceed the breaking point of the material) and the elasticity of the hammer is low, this type of rings are developed, representing the intersection of the cone of percussion and the percussion platform. During this experiment we also note that if the impact occurs vertically, a ring quasi-circular, similar to that illustrated Frank et al. (1967), is developed. However, during the flint knapping, the knapper does many impacts with certain angle between the hammer and the percussion platform and in those cases, the development of these fractures is asymmetric. The cone may undergo a change of direction as pointed Rugg and Mullane (2001) or a deformation, and sections of the cone of percussion that are projected onto the percussion platform, are in this case elliptical, often becoming open fractures with parabolic shape. These fractures keep a geometric relation to the direction of percussion, and we propose the term “parabolic cracks” to call them.



### 3.3.2 Experimental programme

The main objective of this thesis is to develop a method to infer the laterality from palaeolithic archaeological remains. This method must achieve some conditions. On the one hand, the method should be applicable to archaeological materials that are present abundantly in the record, in the same site and also they should be present in numerous sites. In the Palaeolithic, the knapping and making tools have produced numerous flakes as a result, as knapping waste and as supports for the realization of tools, so flakes are present in numerous archaeological sites and usually are very abundant in each one of them. Therefore, we have based this methodology on the analysis of flakes, focused on the study of the striking platform. On the other hand, this method should be applicable to isolated elements, a single flake in this case, in order to have a large statistical sample.

Furthermore, this method should attend to the physical processes that are involved in the formation of the flake. Other methods like Toth (1985) relied on the different habits of knapping between left and righthanded people, in this case the direction in which the core is rotated during the knapping, to associate with the position of the cortex in the back of a flake, without satisfactory results. Therefore, in this thesis, we have tried to relate a physical issue, the angle of percussion, with some element of the flake, following the approach of Rugg and Mullane (2011). According to them, the orientation of the angle of percussion with a left-handed and a right-handed individual hits on the same point of a flint core to extract a flake is opposite. This, they say, could be related to the orientation of the bulb of percussion. However, Bargalló and Mosquera (2013) showed that it is not possible to identify the laterality of the knapper only and exclusively observing the percussion bulb of a flake. Therefore, the objective of this thesis is to develop a method that allows us to relate the morphology of the flake with the angle of percussion and consequently with the handedness of the knapper.

To do this, first, we have analyze the morphology of the flakes to try to establish what elements in them are associated with the angle of percussion and consequently with the

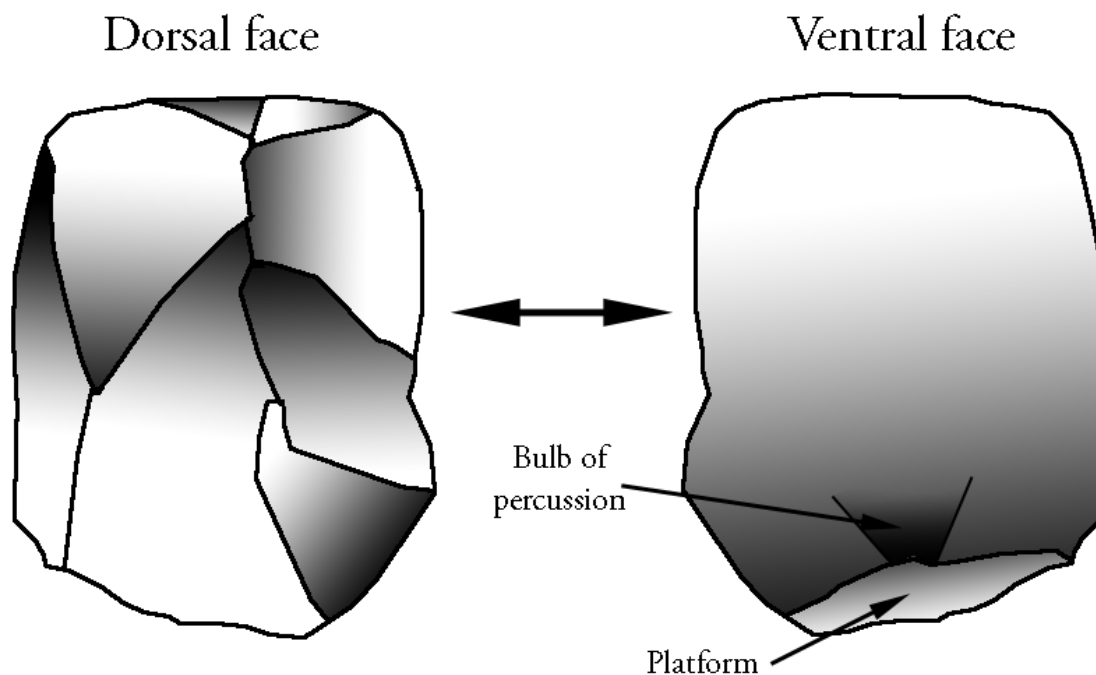

Figure 3.12 Dorsal face, ventral face, bulb of percussion and platform of a flake:

laterality of the individual that produces them. Therefore, we studied the orientation of technological and morphological axis, the percussion point position in the platform and the general morphology of the platform. The dorsal face is the part of the flake that maintains part of the original material and where part of the cortex of the core and/or the negatives of previous removals are preserved. The ventral face displays the surface that is fractured when the flake is removed from the core, and where the bulb of percussion develops. The butt is the part of the percussion platform that is preserved on the flake, where the percussor strikes in order to remove the flake (figure 3.12).

Regarding to the technological and morphological axis of the flake, it was observed that morphological axis was deviated depending to the orientation of the angle of percussion. However, we find that the initial morphology of the nucleus was much more decisive in the final form of the flake. From these observations we decided to focus the study of the morphology of the striking platform. First, we analyzed the general morphology of the platform of a flake. We establish two different morphological types of platforms. Observing the platform with the ventral side of the flake at the bottom, we define an axis perpendicular

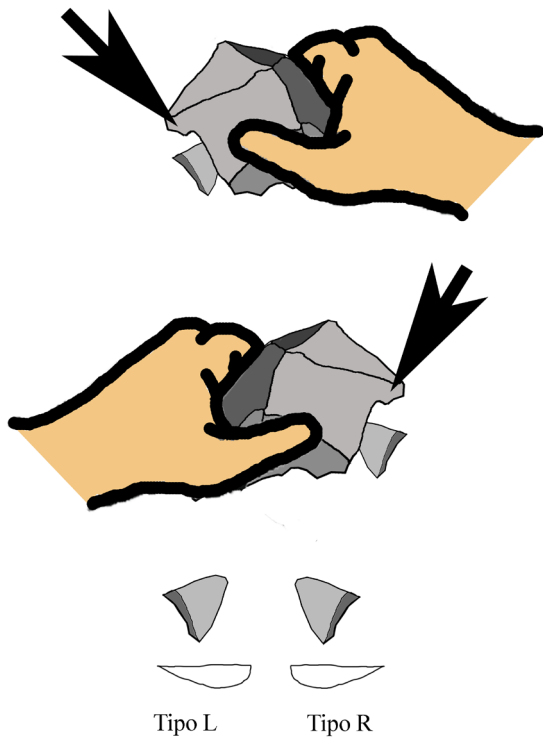

Figure 3.13 Representation of the types of platforms

R and L, and its relationship with the angle of percussion.

to the dorsal surface passing through the point of maximum thickness of the flake. The determination of these two types depends on the position of this axis of the platform in relation to the width of the platform. If the distance from the axis to the right is longer than the left, we are talking about a R platform, and if it is the opposite, about a L platform (figure 3.13). Those that could not be classified in this way fell into the category of undetermined type. The platform type R would be associated with a right-handed knapper and the platform type L with a left-handed.

A preliminary experiment was performed to establish the relationship of these two types with the handedness of the knapper. We studied the flakes produced by the four different knappers: Righthanded-expert, lefthanded-expert, righthanded-novice and lefthanded-novice.

Reference	Handedness	Experience
Knapper 1	Right-handed	Expert
Knapper 2	Right-handed	Novice
Knapper 3	Left-handed	Expert
Knapper 4	Left-handed	Novice

Table 3.4 List of subjects participating in the experiment, their handedness and level of experience.

In a first phase the four subjects (table 3.4) knapped separately to produce a minimum of 100 flakes. These flakes were numerated randomly, so there is no possibility of associating the knapper with the number, and collected in a database recording the knapper who has

produced each flake. In a second phase, two people, who until then had been outside the experiment classified the flakes, based on the categories “Type R”, “Type L” and “Indeterminate Type”.

As a result of this preliminary experiment it was determined that in only 62.5% of the cases the laterality of the knapper coincided with platform type defined above. The number of flakes in which this method could be applied was very small. Therefore, the general morphology of the platform was not suitable to relate the laterality of the knapper with it. It was determined that in this case there was also a strong influence of the original morphology of the nucleus.

Subsequently, the existence of an interesting element around the percussion point was observed. Sometimes, when the bulb develops prominently, its intersection with the platform, can achieve an asymmetrical shape presenting a depression beside the point of percussion. In these cases the profile of the bulb in the platform, is like the wing of a seagull so we call it seagull. This element also seemed related to the orientation of the angle of percussion

*seagull tipo R*



20 mm



*seagull tipo L*



20 mm

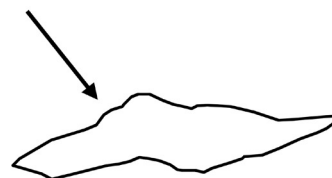

Figure 3.14 Seagull types according to the position of the depression relative to the impact point.

but did not seem to be influenced by the morphology of the nucleus as it was in the central part of the platform.

To determine if the seagull was related to the angle of percussion, we conducted a preliminary experiment. Two different types of platform based on the type of seagull they had. The striking platform with a seagull having the depression to the right of the point of impact (placing the flake with the ventral side up and watching from the platform) was defined as R type, and which presents a seagull with depression on the left of the impact point was defined as type L (figure 3.14). Two knappers, one left-handed and one right-handed, produced 131 flakes that were classified according to the type of platform.

We were able to define this element in approximately 80% of the studied flakes, however, there was great difficulty in identifying this element and, because of this, we only were able to relate correctly the handedness of the producer of the flake with the type of platform defined above in 56.2% of cases. However, during this experiment, it was concluded that if there was any element related strongly with the angle of percussion and consequently with the laterality of the knapper, should also be related to the point of percussion. This element receives the impact first so it should be the best recorder of the angle of incidence of the stroke of the hammer.

Thus, we started attending to the technological and morphological axes, without success, and then we continued analyzing an element directly related with percussion: the platform. In the same way, we began an analysis of the elements farthest from the point of percussion as the morphology of the perimeter of the platform, also unsuccessfully, and then we continued analyzing the elements more related to the percussion such as the seagull structures.

Finally, our reasoning led us to study in depth the point of percussion, the element of the flake related more directly with the hit of the hammer, noting that sometimes certain fractures that could be directly related to the direction of percussion occurred. Therefore, we have developed an experimental program, which we will develop in this section, to determine if

these fractures effectively are related to the direction of percussion and therefore can help us to know the handedness of the individual that produced it.

### 3.3.2.1 Materials and Methods

A system of fractures, around the point of percussion, similar to a ring crack, occasionally forms in connection with the cone of percussion and the conical fracture of the flint. The present section aims to test two hypotheses: 1), that the direction of percussion can be deduced from these fractures, and 2), that the knapper's handedness can be determined from a flake if the direction of percussion is known. These fractures are called parabolic crack.

### 3.3.2.2 Development of the “parabolic crack” under the percussion with different materials

Before studying these fractures from the point of view of the laterality, we must analyze how they are created and how they develop. It is important to know how it influences the type of hammer used in the creation of this type of fracture. To do this, we must properly analyze the behavior of a flint core when it is hit by different types of hammers, analyzing the development of these fractures. In this section we will discuss the formation and development of the parabolic crack depending on the use of three types of hammers: boxwood, antler, limestone and quartzite stone.

In the mid-twentieth century, Bordes (1947) spoke of the differences that can be seen in a flake depending on the percussor used. Contrary to the opinion at that time, he claimed that it is the weight of the percussor and not the violence of the impact which determines the size of a flake. In this way, he explained that a gentle blow with a heavy percussor can obtain large flakes, whereas a very violent blow with the light percussor may not break off a flake. To illustrate this point, he pointed to the manufacturers of rifle flints, who used a large range of percussors of different weights.

Later, numerous studies have characterised the elements identified in flakes and have related them with the percussor type to a greater or lesser extent. Pelcin (1997) studied eleven attributes of flakes and assessed their relationship with the use of two percussor types: a steel ball (emulating a stone percussor) and a red deer antler. In this way, he succeeded in associating some of the characteristics of the debitage products extracted by three knappers during the experimental production of a biface using both hard and soft percussors. He observed that there was greater variability in the characteristics between the flakes of the different knappers than between those removed with different percussors. Equally, experimental studies have related the characteristics of blades with the type of percussors used to make them (Driscoll and García-Rojas, 2014; Pelegrin, 2000, 1995). These studies, which concentrate on blade production, can provide information about the same process in flake production, although comparisons must be made with caution, as the reduction technique is completely different.

Our initial hypothesis is that the physical property of percussors that most influences the

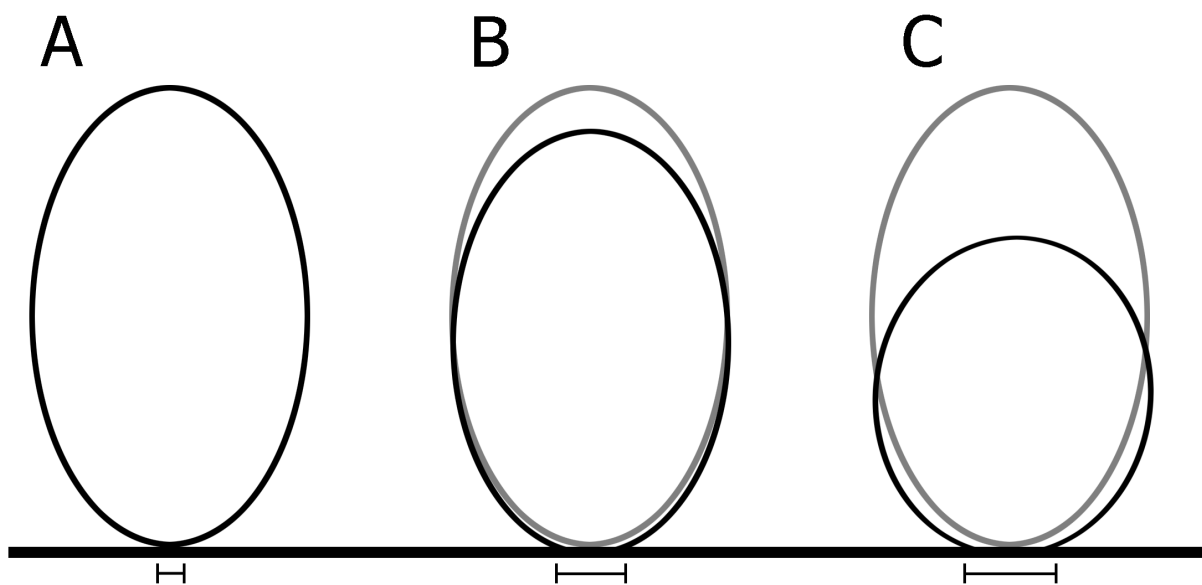

Fig. 3.15 Theoretical deformation of percussors, according to their elasticity, when impacting on a flat surface. The original shape of the percussor is shown with faint lines and its form at the moment of maximum deformation in bold. The impact surface is shown under each percussor. (A) Non-elastic percussor (the undeformed shape is the same as the shape in maximum deformation), (B) percussor with intermediate elasticity, and (C) highly elastic percussor.

knapping process, and therefore in the development of the parabolic cracks, is the elasticity of the material. Experimentation has been carried out in which a series of flakes have been extracted using percussor types with different elasticity: quartzite, limestone, antler and boxwood. The results show that, depending on the percussor elasticity, when a flake is removed, a series of parabolic cracks appear on the percussion platform that are preserved on the butt.

The main percussors used in the Palaeolithic (hammerstones, antler and wood) possess different elasticity, which conditions the fracture during lithic reduction. Elasticity is the capacity of materials to deform so that, in the case of a relatively elastic percussor its shape adapts to the percussion platform and increases the contact surface, thus spreading out the force (Figure 3.15). If a percussor is less elastic, the force of the impact is concentrated in a smaller area, sometimes producing the appearance of a ring crack and the parabolic cracks associated with it. Therefore the presence and nature of these fractures indicate the elasticity of the percussor and it can be determined whether this was made of limestone or quartzite, which possess relatively low elasticity, or of antler, which is more elastic, or of wood, which is the most elastic.

Table 3.5 lists the weight, as a reference, and the maximum length and width of the different percussor types used in the experimental programme: limestone and quartzite, antler and boxwood. It also gives the elasticity or Young's modulus of the different materials. In the case of the two rocks, limestone and quartzite, an interval is given representing the general elasticity modulus of these rock types. The reason for defining a range is the heterogeneous nature of the rocks and their anisotropic properties, which mean that the elasticity of the material varies slightly depending on the direction of the application of the force. Other authors have defined the modulus of elasticity of various rocks (Blair, 1955; Coates and Parsons, 1966; Farmer, 1968; Heidari et al., 2010; Hosking, 1955; Nicholls, 1961; Windes, 1950), establishing intervals similar to those given in Table 3.5 In the case of antler, the modulus of elasticity is that of dry antler as, according to Currey et al. (2009), the value is slightly less when it is still fresh. To define the modulus of elasticity of boxwood, the re-



ference is the range in which Kretschmann (2010) includes a group of wood types called hard woods, which are also heterogeneous and anisotropic materials. All these materials are significantly more elastic than steel in general, which has often been used for percussion in experimental studies. According to Halliday, Resnick, & Walker (2010), A-36 steel, for example, possesses a Young's modulus of about 2,000,000 kg/cm<sup>2</sup>, more than double that of quartzite. Among the percussors used here, stone (limestone and quartzite) is the least elastic, antler is relatively more elastic and box is the most elastic (Table 3.5).

<b>Raw material</b>	<b>Weight (g)</b>	<b>Maximum length (cm)</b>	<b>Maximum width (cm)</b>	<b>Elasticity (kg/cm<sup>2</sup>)</b>
Quartzite	405	10	6.5	900,000-500,000A
Limestone	457	11	6.5	700,000-200,000A
Antler	198	18	3.5	170,000B
Wood	527	21	7	130,000-60,000C

Table 3.5 Size, weight and elasticity of the different percussors used. (A) range for quartzite and limestone in general (Guruprasad, Ragupathy, Badrinarayanan, & Rajkumar, 2012); (B) value for dry antler (Currey et al., 2009); (C) range for hard wood (Kretschmann, 2010).

The material chosen for reduction was flint of the Flysch-Kurtzia variety which outcrops on the coast of Biscay and is one of the main flint varieties used in this area in the Palaeolithic. Previous experimentation has shown that the flint variety does not influence the presence and nature of the parabolic cracks.

In the experimental programme, the same expert knapper has taken part in several sessions which consisted of extracting flakes from several flint cores. A knapping session was held for each type of percussor and each flake removed has been recorded and measured. The measures we have taken are the maximum length (measured perpendicular to the platform of the flake), the maximum width (measured perpendicular to the maximum length, in the plane perpendicular to the platform of the flake) and the maximum thickness (measured perpendicularly to the plane formed by the other two measures). Only the flakes with

a butt susceptible of developing parabolic cracks have been considered; in other words, all the remains with a punctiform, cortical or linear butt have been discarded, as well as all the distal flake fragments. The debris, defined as remains smaller than 3mm long or wide, according to Driscoll (2010) was also discarded, as their butts are so small that they do not allow the development of parabolic cracks.

Once the flakes had been collected and catalogued, they were studied with a stereoscopic microscope at x20 magnification. The knapper produced 421 flakes with the four percussor types, irrespective of the amount of raw material needed and with no pre-determined objective, apart from the extraction of flakes itself. In total, 102 flakes were extracted with the quartzite hammerstone, 103 with limestone, 114 with the antler percussor and 102 with the boxwood percussor. The presence or absence of the flake butts were characterised according to three categories: visible with the naked eye, visible only with the stereoscopic microscope, and absent (Figure 3.16). Table 3.6 gives the number of flakes in each category produced by each percussor.

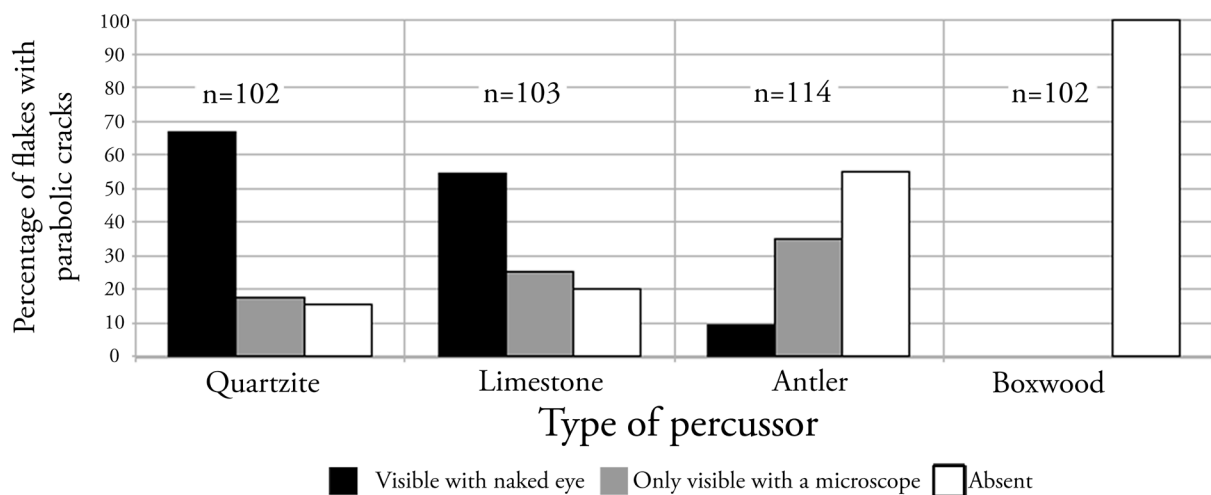

Fig. 3.16 Presence and absence of parabolic cracks according to the percussor types used.

	Percussor			
	Quartzite	Limestone	Antler	Boxwood
Visible with the naked eye	68	56	11	0
Only visible with a microscope	18	26	40	0
Absent	16	21	63	102
<b>Total</b>	102	103	114	102

Table 3.6 Relationship between the percussor type and the number and type of parabolic cracks on the flake butts.

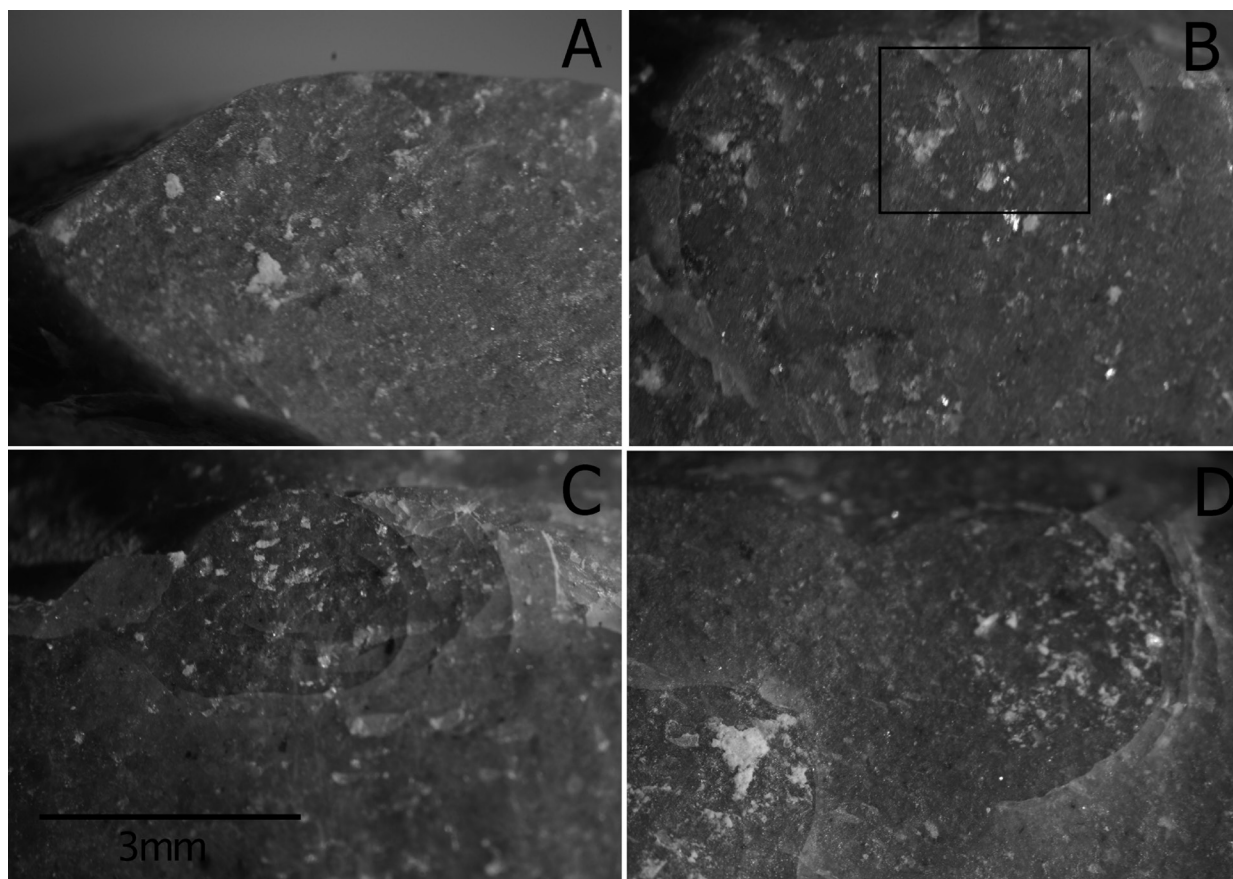

Figure 3.17 Examples of parabolic cracks on the butts of flakes extracted by the impact of: A) boxwood percussor; B) antler percussor (the area with the crack is inside the square; c) limestone percussor; and D) quartzite percussor. Photographs at x20 magnification.

Figure 3.17 shows four examples of impact points on flake butts, each one produced with a different percussor. Photo A is the percussion area on the butt of a flake removed with a boxwood percussor. No parabolic cracks can be seen either with the naked eye or with a stereoscopic microscope at x20 magnification. Photo B is the butt of a flake removed with an antler percussor, in which some small parabolic cracks are appreciable although they are imperceptible with the naked eye. Photos C and D are the butts of flakes removed with limestone and quartzite respectively. In both of them, the cracks can be seen both with the microscope and with the naked eye. Bearing in mind the magnification at which the cracks are being viewed with the microscope, it can be concluded that for a parabolic crack to be visible with the naked eye, it must be about 2mm long, or consist of several cracks together.

Glass has often been used as the raw material for cores in monitored experimentation to study flint fracturing (Cotterell et al., 1985; Dibble and Pelcin, 1995; Pelcin, 1997). The advantages of using this raw material are, among others, that it can easily be handled and is easy to obtain. In addition, it is argued that glass behaves like an “ideal” flint, isotropic and without imperfections. However, glass and flint are completely different materials. Whereas flint is a sedimentary rock, formed by an aggregate of crystals, glass is vitreous. They both display conchoidal fracturing but, owing to the numerous differences between them, it may be supposed that their physical behaviour is not identical.

In 1987, Cotterell & Kamminga studied the formation of flakes in different materials and analysed the mechanics of the fracturing of a brittle solid, based on the earlier work of Griffith (1920), who described the original concept of the fracture of brittle materials, and of Lawn & Wilshaw (1975), who also studied the behaviour of these materials. They showed how, in homogeneous siliceous materials, the “process zone” at the tip of a crack, where the rock is deformed inelastically and the fracture occurs, is relatively small. However, if the material possesses impurities, like most of the materials used in the Palaeolithic, the crack forms in the face and on both sides of the propagating crack and a larger “process zone” may appear (Cotterell and Kamminga, 1987). According to these authors, outside the fracture-process zone, the force ( $\sigma$ ) near the “crack tip” can be described as a function of a

parameter called “stress-intensity factor (K):  $\sigma = K/\sqrt{2\pi r}$ , where  $r$  is the radius of the process zone (Lawn and Wilshaw, 1975). The fracture will occur when the stress-intensity factor (K) reaches a limit called fracture toughness ( $K_{IC}$ ) which is specific to each material. For glass, the  $K_{IC}$  is  $25 \text{ N mm}^{-3/2}$  (Holloway, 1973). However, for polycrystalline quartz with more impurities, which is used for lithic reduction, it is much less. For jasper it is  $60 \text{ N mm}^{-3/2}$  (Schindler et al., 1982) and it drops to  $30 \text{ N mm}^{-3/2}$  when the rock is heated to  $300\text{-}400^\circ$ . In addition, the energy available for the fracture is proportional to  $(1-\nu^2)K^2/E$ , where  $E$  is the modulus of elasticity and  $\nu$  is the Poisson coefficient, which for lithic materials is about 2 (Lawn and Wilshaw, 1975). The energy needed to produce a fracture in each material is different, as there is a different  $E$  for each material.

Therefore, glass and flint do not behave in the same way, as they possess different fracture toughness ( $K_{IC}$ ) and a different modulus of elasticity ( $E$ ). This causes differences in how this type of fracture develops and other particularities of each material, such as the elastic limit. As a result, Le Bourhis (2008) studied several types of glass from a mechanical and technological point of view and analysed their properties exhaustively. According to Le Bourhis, the glass types display major differences and even the way of preparing the glass changes its properties. Depending on the needs of each manufacturer, glass is made with certain elastic behaviour and therefore the way of fracturing varies greatly between the different types, and consequently it will also differ from the behaviour of flint. Because of this, the best way to understand lithic reduction through experimentation is to emulate it by using the same materials as the raw materials used in prehistory, in this case flint.

Furthermore, in these studies (Dibble and Pelcin, 1995; Pelcin, 1997), mechanical devices were used in order to eliminate the human factor, so that all the impacts involved the same force. However, if we wish to apply our results to archaeological assemblages produced by humans, we should take the idiosyncrasy of lithic reduction into account. The final force of the blow between the percussor and the core will be determined by the weight of the percussor and the strength imparted by our arm (acceleration). In lithic reduction, experienced knappers control the force according to two parameters almost unconsciously. In this way,

they generate less acceleration when using a heavy percussor and vice versa, depending on their needs as knappers. Additionally, in the studies that attempted to mechanise knapping to eliminate the human factor, for technical reasons they used a steel ball, whose behaviour may be very different from that of a hammerstone because, as stated above, their elasticity is different. It can also be added that these percussors are generally fixed in mechanical structures, in the case of both a steel ball and antler, which means that at the moment of impact, the system of forces is different from that occurring if the percussor is held in a human hand. The force is absorbed differently if, for example, a steel ball 5cm in diameter fixed in a mechanical device is used (as in Pelcin, 1997), or if an antler larger in size, held in the knapper's hand, is used. Therefore, if in our experimentation we wish to emulate Palaeolithic lithic reduction, the use of human knappers is preferable to mechanical devices.

In sum, bearing in mind that the nature of the materials used as percussor and core condition the fractures, and that the use of mechanical devices does not emulate lithic reduction satisfactorily, experimentation with flint and manual methods supplies results that can be regarded as more representative. This means that the association between the percussor type and presence/absence and character of the parabolic cracks on the flake butts can be significant, within the circumstances in the present experimentation.

Numerous experiments have studied lithic reduction by converting it into a mechanised process, carried out with artificial devices. However, knapping was performed by humans and therefore experimentation should be designed in accordance with that premise. However, to monitor the effect of the percussor type, to produce a flake in this case, the main variables should be isolated, whilst always bearing in mind that knapping was a human activity. Equally, the use of metallic percussors or other materials fixed in mechanical devices does not emulate Palaeolithic reality correctly. Experimentation can always be carried out with glass or other materials to understand their behaviour or as preliminary experiments, but if we aim to apply these results to lithic reduction, mostly involving flint or quartzite, it must be recalled that the two materials do not behave in the same way, and their fracture, the development of the ring crack and the final shape of the flake may vary significantly.

In the present experiment, four types of percussor that may have been in use in prehistory were tested: quartzite, limestone, antler and boxwood. These percussors display different elastic behaviour, where wood is the most elastic, antler is more elastic than limestone and quartzite is the least elastic of the four. This provides the knapper with a range of materials and possibilities when carrying out lithic reduction (Table 3.5).

It has been seen that stones (both quartzite and limestone) produce numerous parabolic cracks, visible with the naked eye, whereas the antler percussor produces fewer cracks, which are smaller and many of them are only visible with a microscope. Finally, this type of crack has not been identified in the case of percussion with a wood percussor (Figure 3.16).

According to the results of this experimentation, conducted in the conditions explained above, it can be concluded that there is a tendency to produce parabolic cracks when a less elastic hammer is used (limestone and quartzite). In contrast, relatively more elastic percussors (antler) produce fewer parabolic cracks and even, in the case of boxwood, produce none at all. The study of the parabolic cracks in a lithic assemblage, combined with the analysis of other variables proposed in the literature, may enable a simple and statistically significant determination of the percussor mostly used for reduction.

### 3.3.2.3 Empirical observation

During the experimentation described in section 3.3.3, in which the effects of the impact of a limestone hammerstone on a flat flint surface were studied, we observed the appearance of a ring crack and its relationship with the bulb of percussion. Clarkson (2007) described it as:

“Conchoidal flakes (i.e. those with Hertzian initiations) often retain a ring crack at the point of force application (PFA), and an *eraille* scar just below the point of percussion on the bulb of force.”

The bulb is conical and when the percussion is very violent (over the breakage limit of



the material), and the hammerstone is very rigid (not elastic), these types of rings form, representing the intersection of the cone of percussion (or incipient cones) with the striking platform. During this experimentation, it was also observed that if the impact is vertical, a quasi-circular ring, similar to the illustration in Frank (1967), is formed. However, most of the impacts occurring during flint reduction are at a certain angle between the hammerstone and the striking platform and then the fractures do not form symmetrically. In consequence, as Rugg and Mullane state (2001), the cone undergoes a change in orientation or is skewed, and the sections of the cone of projection that are projected as fractures on the striking platform are elliptical and often open, in a parabolic shape. A parabola (Figure 3.18 A) is defined as the locus of points in a plane equidistant from a line called directrix and a point outside it called focus. The vertex of the parabola is the point whose distance from the directrix is minimal. The axis of symmetry of a parabola is a vertical line through the vertex and divides the parabola into two congruent halves. We observed that these cracks are related geometrically with the direction of percussion. We propose the term “parabolic crack” for these fractures.

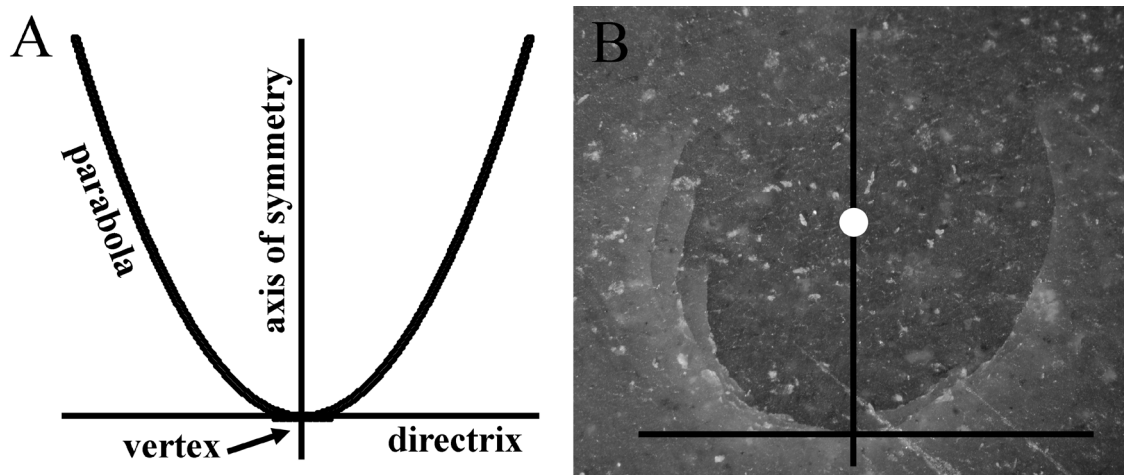

Figure 3.18 (A) Illustration of a parabola showing the axis of symmetry, the directional line and the vertex. (B) Detail of a parabolic crack. The white dot represents the point of percussion.



#### 3.3.2.4 Experimental testing

Figure 3.18 illustrates the shape of the parabolic crack and marks its axis of symmetry. Based on our observations, we hypothesized that this axis indicates the direction of percussion. To test this, in the first place, we built a device with which a flat flint surface can be struck after pre-determining the direction and inclination.

For this purpose, we have designed a “percussion machine” (Figure 3.19) consisting of a rotating and tilting turntable (Figure 3.19 B), where the flint fragment (Figure 3.20) is placed. A hammer percussor above (Figure 3.19 A) it falls by gravity vertically on to the fragment, and, therefore, the direction and inclination (Figure 3.19 C) of the impact on the flint is determined by the position of the turntable. In this way, the direction of the impact can be varied by rotating the turntable, which has a scale so that the exact direction of the blow can be recorded. The tilting mechanism also has a scale, so that the desired angle of blow can be fixed by tilting the turntable. This device is based on earlier models used to strike with pre-determined inclinations (Dibble and Whittaker, 1981). Their design has been modified by using a rotating turntable allowing the direction of impact to be measured, and the original tilting system has been altered so that the inclinations can be measured more easily.

To strike the flint in a particular direction, first of all the fragment must be fixed firmly in a horizontal position on the turntable. To fix the fragment of flint in the plate we used two metal fasteners anchored to the turntable (Figure 3.19 B). Then the turntable is rotated in the desired direction and tilted to determine the angle of blow. A reference line must be marked (Figure 3.19 A) to be able to take the relevant measurement when the impacted flint is removed. To do this, we simply have to make a straight line on the surface of the fragment of flint, and measure its direction. Finally, the percussor (Figure 3.19 A) is released, and this impacts on the flint surface. To take the measurements, it is not necessary to remove a flake. It is only necessary for the impact to be powerful enough to create parabolic cracks around the point of percussion.

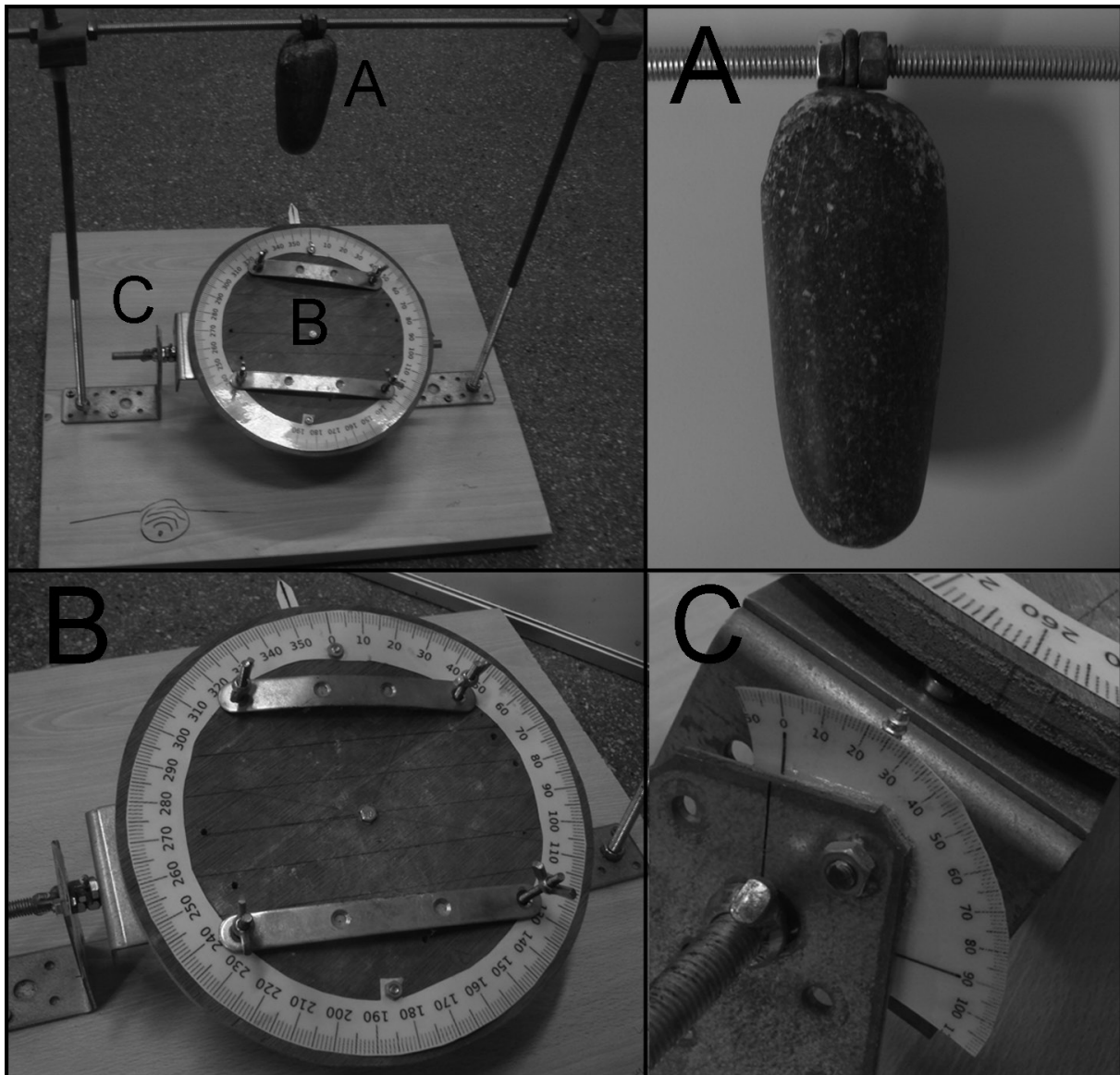

Figure 3.19 (A) Design of the percussion machine. (B) Percussor. (C) Flat fragment of flint that is placed on the turntable.

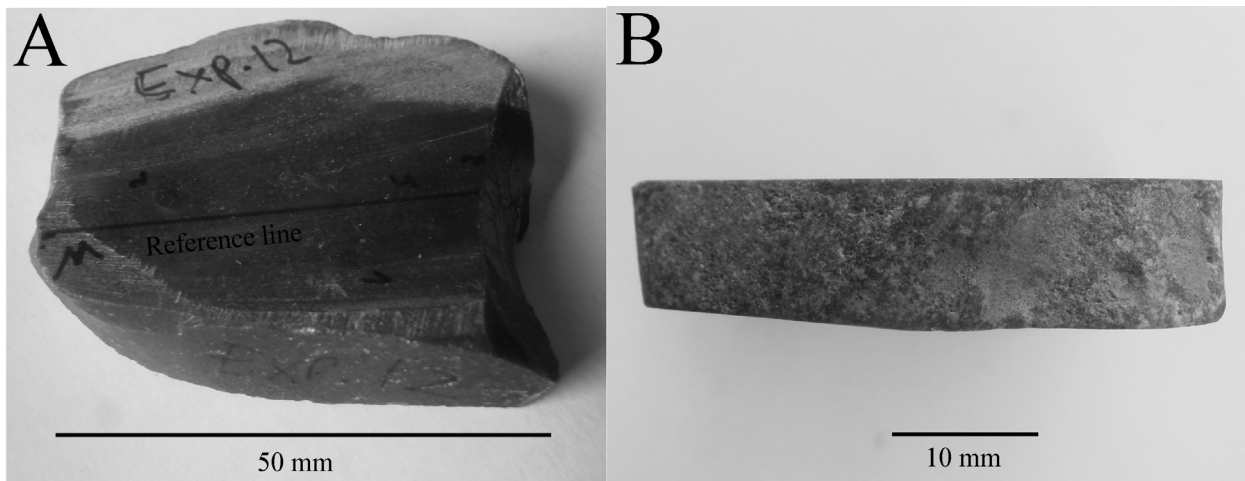

Figure 3.20 The fragment of flint with the reference line (A) and the two parallel surfaces (B).

The flint surface to be struck must be completely flat and parallel to the turntable, for its inclinations and directions to be the same as those of the turntable. Therefore, pieces of flint (Figure 3.20 A) with two parallel flat surfaces (Figure 3.20 B) must be cut previously. The flint fragments were cut in the UPV / EHU using an Audi Mod. E-Industrial (disc cutter: Ø 300- Ø 600 mm.). One surface is fixed to the turntable, and the other receives the impact.

The object used for the percussion was a hard limestone hammerstone (100x50x40 mm). The choice of percussor was determined by the results of prior experimentation in which flakes were struck off with different types of percussor: quartzite, limestone, antler and boxwood. It was seen that the stone percussors (both quartzite and limestone) produce numerous parabolic cracks and were, therefore, suitable for the present study.

The material chosen for the experiment was flint of the Flysch-Kurtzia variety which outcrops on the coast of Biscay and is one of the main flint varieties used in this area in the Palaeolithic. Previous unpublished experimentation has shown that the flint variety does not influence the presence and nature of the parabolic cracks.

A series of tests was performed with this device, in an attempt to associate the shape of the parabolic cracks with the direction and line of the respective percussion events.

We have defined the following independent and dependent variables:

a) Independent variables:

These variables are perfectly measurable and controllable by the percussion machine (Figure 3.21):

- Percussion vector: is the vector tangent to the trajectory of the hammer at the moment of the impact.
  - Direction of percussion: the direction of the percussion vector.
  - Endpoint of percussion: the endpoint of the percussion vector.
- Plane of trajectory: vertical plane containing the vector of percussion.
- Percussion angle: angle formed by the vector of percussion and percussion platform.
- Percussion vector projection: the projection of the percussion vector on the platform of percussion.

The percussion vector direction is tangent to the trajectory of the percussor and its line is that of the percussion. In turn, this vector can be divided into two; one orthogonal to the plane of percussion and a second contained in this plane. The latter, which is the projection of the percussion vector on the plane of percussion, contains the directional component that is of interest, as explained below (Figure 3.21).

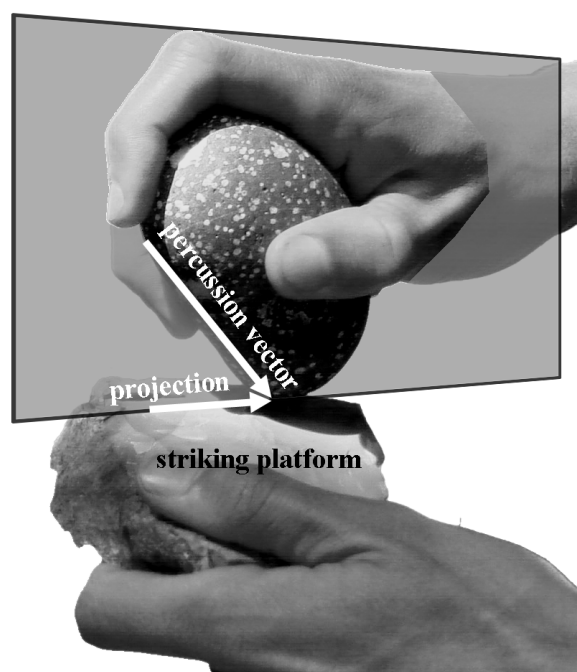

Figure 3.21 Representation and spatial relationship between the percussion vector and its projection on the striking platform.

b) Dependent variables:

From the parabolic crack we can define a vector (parabolic crack vector) whose direction and endpoint are the dependent variables (Figure 3.22).

- Direction of the axis of symmetry of the parabolic crack: direction of the symmetry axis of the parable formed by the parabolic cracks.
- Endpoint of parabolic crack: the concavity of the parable indicates where the endpoint of the parabolic cracks is.

So, based on the parabolic crack, another vector can be defined, called the parabolic crack vector, whose direction is the axis of symmetry of the parabola formed by the parabolic cracks and whose line is indicated by the concavity of the parabola (Figure 3.22 B). The position of the vertex of the parabola can be determined as the parabolic cracks are more numerous and closer together at that point. In addition, small cracks sometimes develop in the form of smaller parabolas (Figure 3.22 A). The identification of the vertex helps to establish the direction and line of the axis of the parabola.

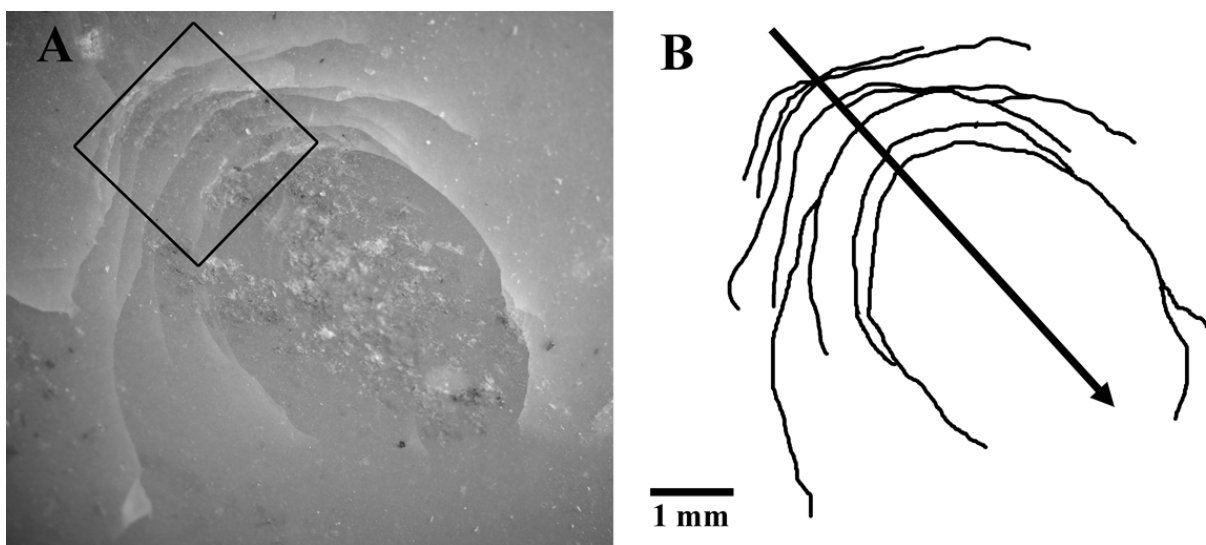

Figure 3.22 Detail of parabolic cracks: (A) concentration of cracks in the position of the vertex of the parabola. (B) direction and line of the parabolic crack vector.

Once the vertex of the parabola is identified, we can draw its axis of symmetry. This axis is the line through the vertex and equidistant from both sides of the parabola. The direction of this vector is determined by the concavity of the parabola.

c) Relationship between dependent variables and independent variables:

Our original hypothesis is that the parabolic crack vector coincides with the projection of the percussion vector on the percussion platform (Figure 3.23). In this way, the direction of the axis of symmetry of the parabolic crack will coincide with that of the projection of the percussion vector and consequently, the concavity of the parabolic crack will indicate its line. The angle of blow cannot be determined, but if the projection of the percussion vector is known, the directional component of the percussion vector on the percussion platform is also known, and this will allow the knapper's handedness to be determined, as explained below.

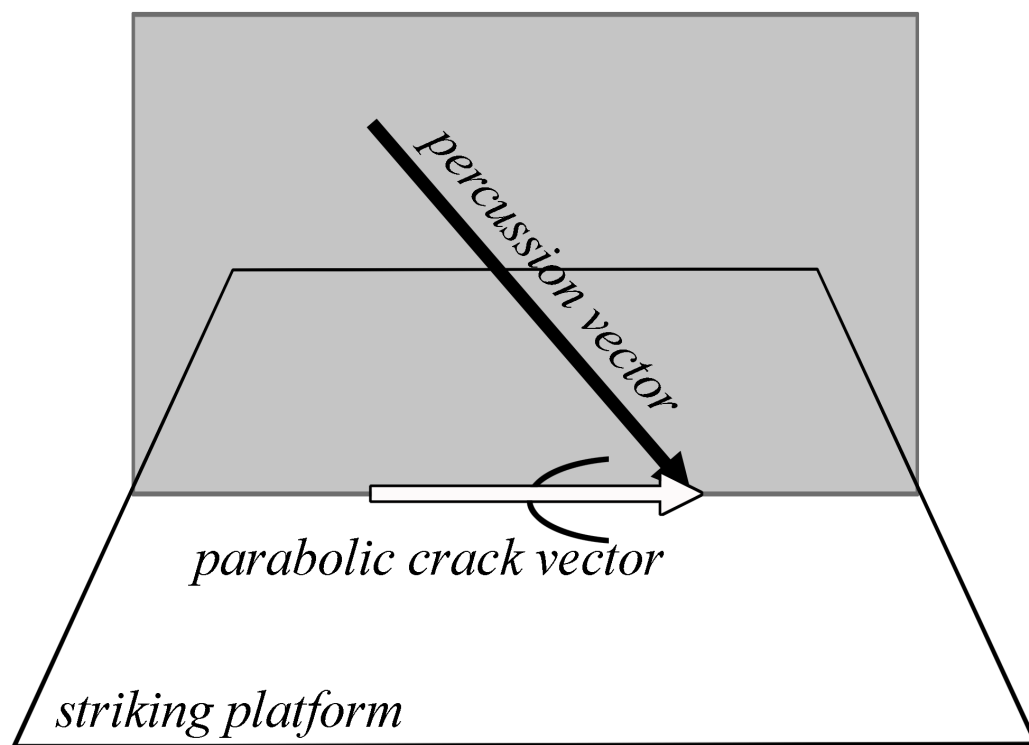

Figure 3.23 Representation of the relationship between the percussion vector and the parabolic crack vector.



In the tests with the percussion machine, 75 impacts were made on a flat flint surface, with an angle of blow between 20° and 30° for all the impacts and with a known direction and line of percussion. We made 15 experiments, using 15 pieces of flint. In each experi-

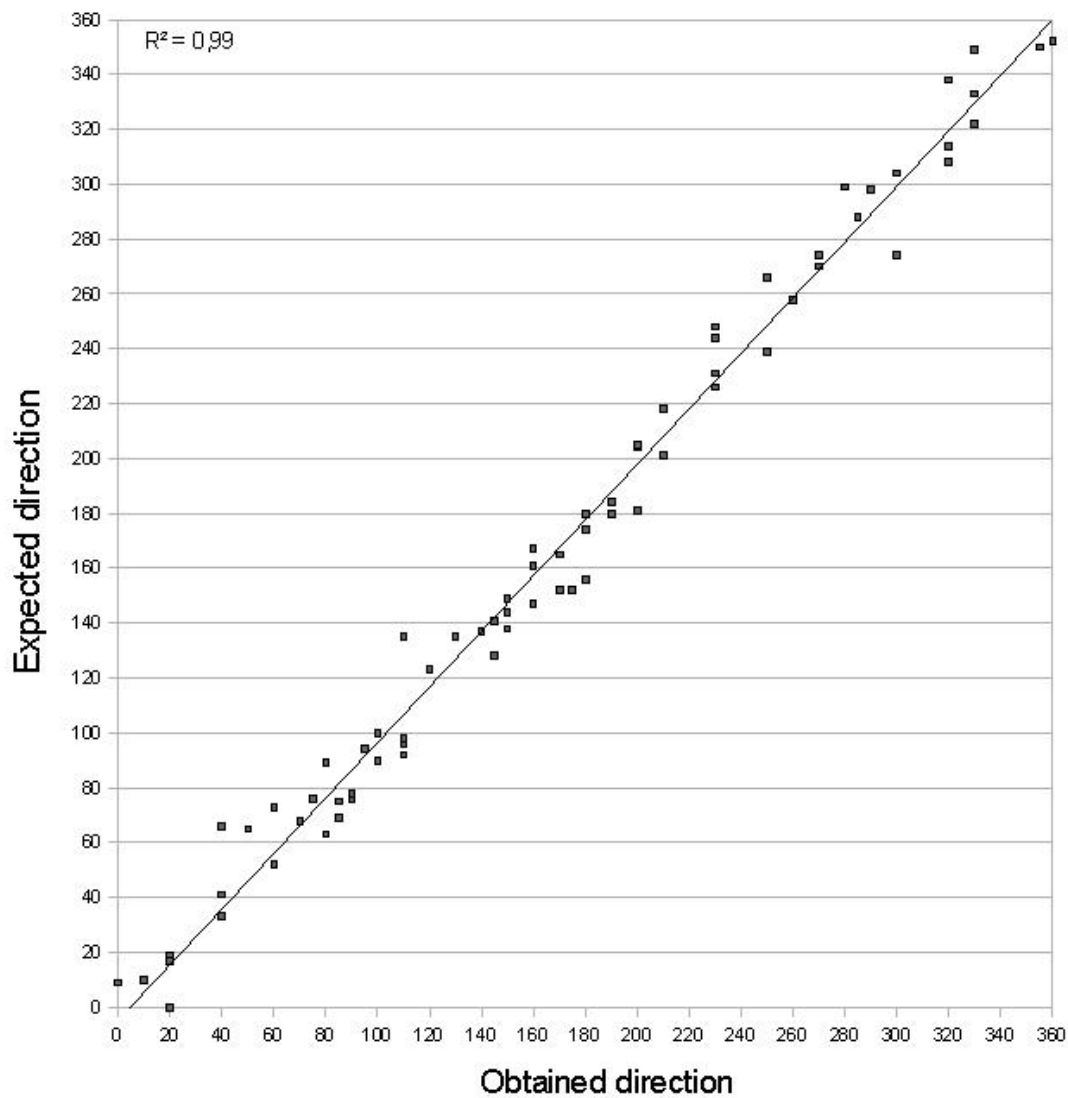
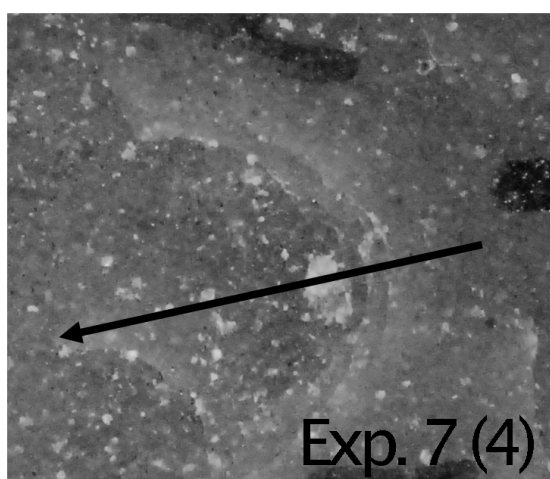
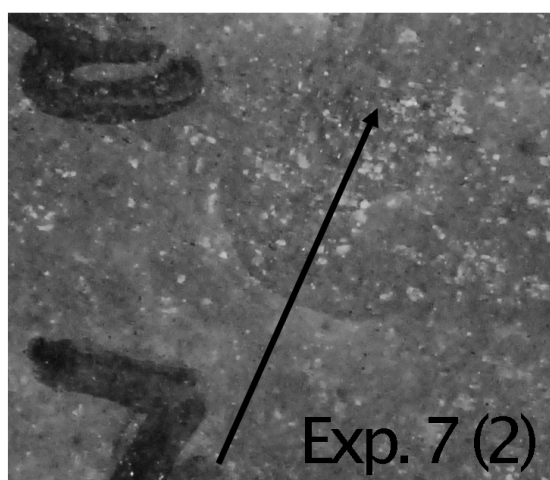

Figure 3.24 Representation of the expected direction compared with the obtained direction and its line of regression (performed using Excel).

ment we make 2-7 impacts (Table 3.7). Later, the orientation of the axis of symmetry of the parabolic cracks caused by each of these impacts was measured. The axis of symmetry was measured on a photograph using Photoshop software, through its tool “rule”, which allows one to measure angles. In this way we can measure the angle between the axis of symmetry of the parabolic crack and the reference line we have previously drawn. Knowing the orientation of the turntable of this line, we will know the orientation of the axis of symmetry,

when it was set on the plate. It was seen that this coincides with the projection of the percussion vector and that its concavity indicates the line of percussion with a mean error of  $9.3^\circ$  and maximum error of  $26^\circ$  (Table 3.7).



**3 mm**

Figure 3.25 Examples of impacts on a flat flint surface and the projection of the percussion direction and line, estimated from the parabolic axis of symmetry.

The regression line relating these two variables has an  $R^2$  of 0.99 (Figure 3.24). It can, therefore, be claimed that by knowing the shape of these fractures, the projection of the direction and line of the impact on the percussion platform, which is to say the source of the impact, can be determined. Figure 3.25 shows two examples of impacts measured following the method described above. The symmetry axis, which passes through the vertex and which divides the parabola into two symmetrical halves, has been set. In the photos the reference each impact has been tagged, which have been described in Table 3.7.



<b>Nº of impact</b>	<b>Reference</b>	<b>Direction of the impact</b>	<b>Direction of the axis of simmetry of the PC</b>	<b>Error</b>
1	Exp1-1	280	299	19
2	Exp1-2	230	244	14
3	Exp1-3	180	180	0
4	Exp1-4	200	204	4
5	Exp1-8	230	226	4
6	Exp1-9	230	248	18
7	Exp1-10	180	174	6
8	Exp2-2	320	308	12
9	Exp2-3	320	338	18
10	Exp2-4	180	156	24
11	Exp2-5	150	144	6
12	Exp2-6	90	76	14
13	Exp3-1	60	73	13
14	Exp3-2	20	0	20
15	Exp3-3	300	274	26
16	Exp3-4	250	266	16
17	Exp3-5	360	352	8
18	Exp3-6	80	63	17
19	Exp4-1	110	96	14
20	Exp4-2	140	137	3
21	Exp5-1	20	19	1
22	Exp5-2	20	17	3
23	Exp6-1	20	0	20
24	Exp6-2	40	33	7
25	Exp6-3	80	89	9
26	Exp6-4	110	135	25
27	Exp6-5	150	138	12
28	Exp7-1	150	149	1
29	Exp7-2	200	205	5
30	Exp7-3	200	181	19
31	Exp7-4	90	78	12
32	Exp7-5	290	298	8
33	Exp8-1	330	333	3

34	Exp8-2	330	349	19
35	Exp8-3	300	304	4
36	Exp8-4	190	180	10
37	Exp8-5	190	184	6
38	Exp8-6	210	201	9
39	Exp9-1	270	270	0
40	Exp9-2	330	322	8
41	Exp9-3	50	65	15
42	Exp9-6	70	68	2
43	Exp9-7	100	90	10
44	Exp9-8	100	100	0
45	Exp9-9	110	92	18
46	Exp9-10	130	135	5
47	Exp9-11	210	218	8
48	Exp9-12	270	270	0
49	Exp9-13	180	180	0
50	Exp10-1	160	167	7
51	Exp10-2	0	9	9
52	Exp10-3	270	274	4
53	Exp11-2	160	147	13
54	Exp11-3	160	161	1
55	Exp11-4	260	258	2
56	Exp11-5	40	66	26
57	Exp11-6	10	10	0
58	Exp11-7	110	98	12
59	Exp12-1	95	94	1
60	Exp12-2	250	239	11
61	Exp12-4	320	314	6
62	Exp12-5	40	41	1
63	Exp12-6	60	52	8
64	Exp12-7	75	76	1
65	Exp14-1	145	141	4
66	Exp14-2	145	128	17
67	Exp14-3	85	69	16
68	Exp14-4	85	75	10

69	Exp14-6	175	152	23
70	Exp15-1	170	152	18
71	Exp15-2	170	165	5
72	Exp15-3	120	123	3
73	Exp15-4	230	231	1
74	Exp16-2	285	288	3
75	Exp16-3	355	350	5

Table 3.7 List of the impacts made by the percussion machine, the direction of the impact, the direction of the axis of symmetry of the parabolic crack, and the difference between both.

### 3.3.3 Application of the method

Once it was verified that the parabolic cracks are orientated according to the direction of the percussion, a system was designed permitting the knapper's handedness to be determined from the flakes produced. When a flake is removed from a flint core, the hammerstone impacts the percussion platform violently. In the preliminary experiment, we detect that in more than 80% of the flakes produced by direct percussion with a hard hammerstone (limestone or quartzite) (figure 4-15) that conserve part of the percussion platform (excluding flakes with linear, cortical and punctiform butts, and those with a maximum thickness of less than 5mm), parabolic cracks form around the percussion platform (figure 4-17 B), caused by the impact of the hammerstone on the percussion platform. In most cases, the marks are visible and are preserved in the butt of the flake. In the case of flakes with linear or punctiform butts, the fragment of the percussion platform is not large enough for these fractures to be recorded, and they simply do not appear, or are very weak, in cortical areas. As the human arm pivots around the shoulder, elbow and wrist, many of the blows on the percussion platform with the hammerstone will not be vertical (Rein et al., 2013; Williams, E.M., Gordon, A. D., 2010), and, therefore, a certain angle of percussion exists when the core is hit. In the usual knapping process, in which the core is placed on one leg, and the hammerstone is held with the opposite upper limb to hit a particular point on the percussion platform, left-handed and right-handed people strike the core with an equivalent, but

opposite, angle and direction (Fig. 3.26). In other words, their percussion vectors are the mirror image of each other, and also their projections. Therefore, by knowing only the projection of the percussion vector on the plane of percussion, the source of the impact can be determined and it can be established whether it was made by a left-handed or right-handed person (Fig. 3.26).

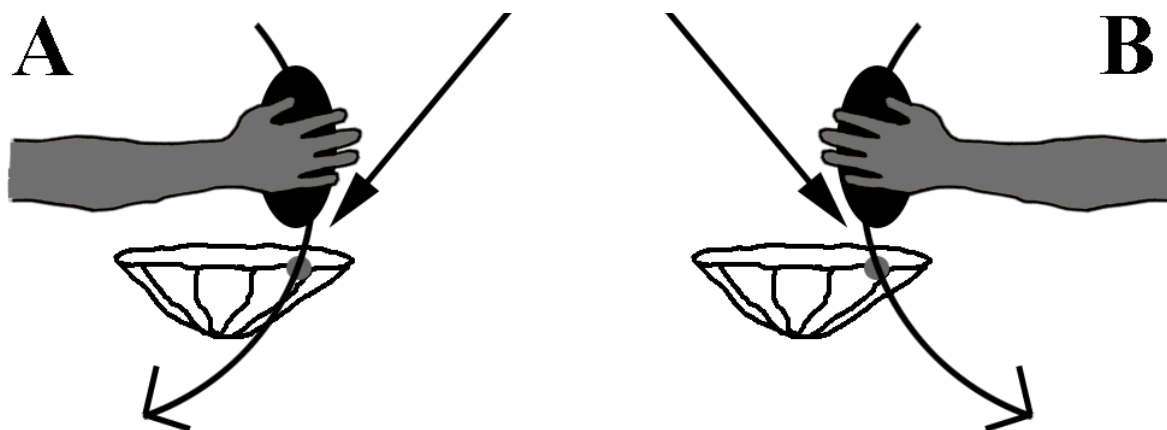

Figure 3.26 Representation of the percussion angles and directions used to strike the same point on a core, in the case of right-handed and left-handed knappers.

As explained above, this projection coincides with the parabolic crack vector, and depending on its orientation with regards to the general shape of the butt, the flakes can be classified in two categories, called R and L (Figure 3.27). Although a flake can easily be assigned to either category, a procedure has been developed to systematise the classification. A flake is placed with its ventral face upwards and the line joining the ends of the intersection of the ventral face with the butt is established as the horizontal reference axis; in most cases this represents the maximum width of the butt. The vertical axis can be established perpendicular to this axis, and this can be used to measure the deviation of the parabolic crack from the axis of symmetry. If the smaller angle that the parabolic crack makes with this axis is on the right-hand side of it, the flake is classed as Type R, and the angle is regarded as positive. If, on the contrary, the angle is on the left-hand side, the flake is Type L, and the angle is regarded as negative.

Flakes without these cracks or in which the cracks are undetectable, or those whose axis

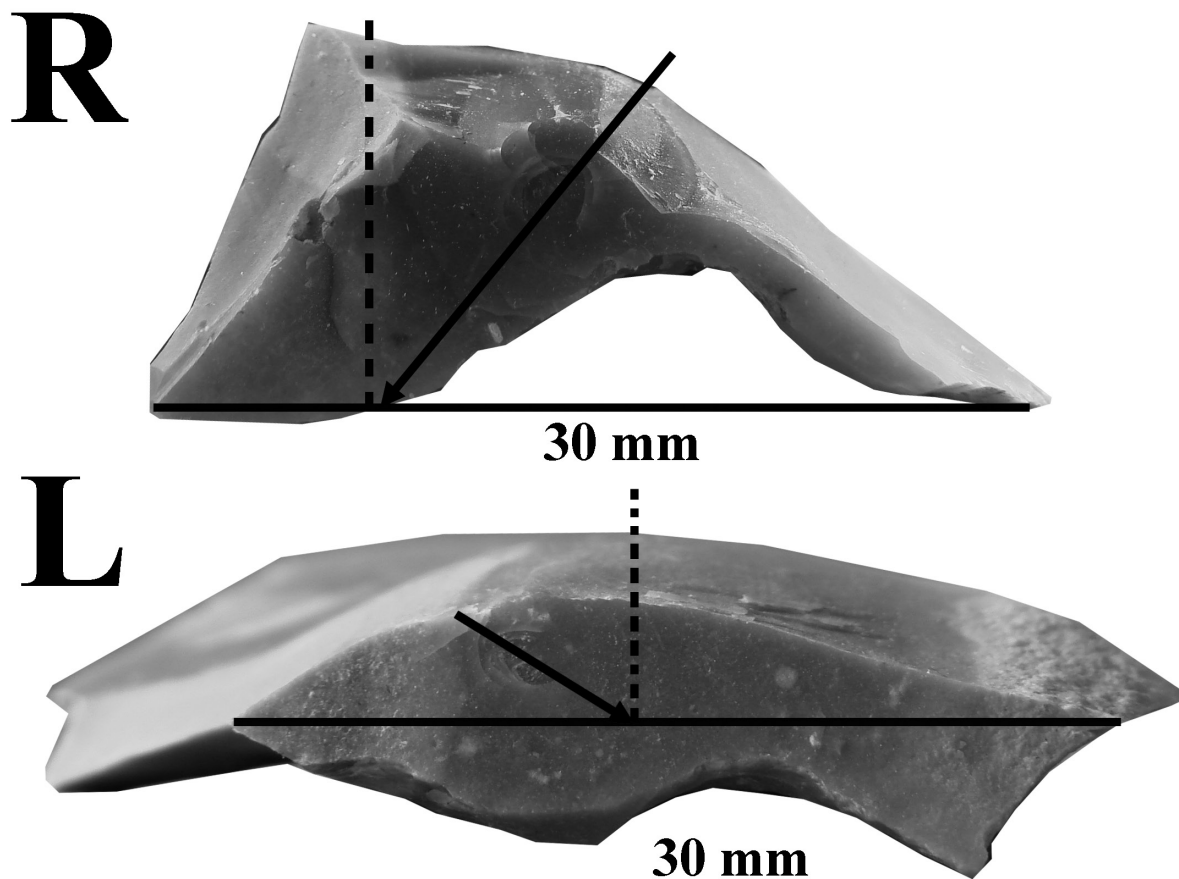

Figure 3.27 Cracks produced in the butt by percussion in the case of flakes extracted by right-handed (R) and left-handed (L) knappers. The percussion directions and lines obtained by the parabolic axis of symmetry are shown.

of symmetry is less than  $9.36^\circ$  from the vertical axis (according to the error determined experimentally), are classed as indeterminable. Also we have measured the maximum length (measured perpendicular to the platform of the flake), the maximum width (measured perpendicular to the maximum length, in the plane perpendicular to the platform of the flake)

and the maximum thickness (measured perpendicularly to the plane formed by the other two measures).

#### 3.3.4 Experimental results

To verify the archaeological application of these observations, a blind test was designed in which four knappers (two right-handed and two left-handed, of which one was an expert and the other a novice in each case) produced 300 flakes in the course of several sessions. Flakes with punctiform, linear and cortical butts, and those thinner than 5mm were eliminated. Later, without knowing the origin of the flakes, each one was classed as R, L or indeterminate, following the methodology described above.

Of the 300 flakes extracted in the blind experiment, 198 (66%) were deemed indeterminate because they did not display a parabolic crack, or because they had several superimposed cracks hindering an adequate interpretation, or because the parabolic cracks were incomplete, next to the edge of the butt. Bearing in mind the error of  $9.36^\circ$  that can be made when associating the orientation of the parabolic cracks with the percussion direction, as determined experimentally, flakes with parabolic cracks whose orientation was less than  $9.36^\circ$  from the vertical reference axis defined previously in the flake butt, were also classed as indeterminate. The other 102 flakes (34%) were classified in either the L or R category depending on their orientations as explained in the methodology. Of these flakes, 95 (93.1%) were correctly associated with the handedness of the knapper. The other seven (6.8%) were classed wrongly.

	Expert		Novice		Expert		Novice	
	Left-handed		Left-handed		Right-handed		Righth-handed	
	N	%	N	%	N	%	N	%
<b>L</b>	27	96,43	5	83,33	2	5,41	3	9,68
<b>R</b>	1	3,57	1	16,67	35	94,59	28	90,32
<b>Indet.</b>	77	73,33	21	77,78	40	51,95	60	65,93
<b>Total</b>	105	100	27	100	77	100	91	100

Table 3.8 Correlation between the types of flakes extracted by the knappers and their handedness.

### 3.3.5 Discussion of the results

Most of the impacts made with a hard hammerstone on a flint surface cause a system of fractures in the shape of a parabola, called parabolic cracks. After studying 75 impacts made with a device that can pre-determine the percussion direction (the percussion machine), it has been established that the axis of symmetry of these cracks coincides with the projection of the percussion direction, with a mean error of 9.3°. This error is due to the parabolic cracks not being completely symmetrical and the direction of their axis of symmetry not being clearly defined. Therefore, several possible lines may define the axis of symmetry of the same parabolic crack. The choice of one or another may cause a maximum error of 26°, with a mean of less than 10° although the error is usually no more than 5°.

These cracks are preserved in the flake butts and their axis of symmetry forms a certain angle with the vertical axis defined by the maximum width of the butt. Bearing in mind the above-mentioned error, it has been determined that the axis of the parabolic cracks skewed to the right of the vertical axis is associated with a right-handed knapper and those skewed to the left, with a left-handed knapper. This is because, in flint knapping, the percussion direction depends on the knapper's handedness. In the case of the two expert knappers who took part in the experimentation, the production of flakes in accordance with their handedness is over 94% (Table 3.8), with each of them producing around a hundred flakes (105 and 77). One of the novice knappers produced a smaller number of flakes (27),

of which only 22.2% (six flakes) could be determined correctly. The inexperience of the knapper means that several impacts are often needed to extract a single flake. Consequently superimposed parabolic cracks form, hindering their interpretation. Similarly, as the force of the blow is not controlled well, many flakes break and the possible parabolic cracks are frequently destroyed. This occurs to the expert knappers too, but less often. The proportion of determinable flakes produced by the experts is always over 25% (Table 3.8).

Out of the total number of flakes, 34% were determinable, and of these only 6.8% were associated with the knapper's handedness wrongly. These flakes were later re-examined, and it was found that the errors were due to two different reasons. First, the flakes extracted by blows in which the knapper struck with the hammerstone facing ahead and not towards himself, or with the core placed frontally, were classed mistakenly as in these cases the percussion angle and direction are those that would normally correspond to a knapper with the opposite handedness. These types of impacts are very unusual in a normal knapping process and often cause knapping errors, which are most common amongst inexperienced knappers. Second, the percussion platform may display irregularities when it is struck, and their inclination may modify the impact direction, which is recorded in the parabolic cracks. This is because, when striking with a certain direction on an inclined or very irregular surface, the impact direction depends not only on the angle and direction of the hammerstone, but also on the inclination and direction of the platform. In general, the knapper seeks a flat percussion platform which is placed with the right inclination to strike it comfortably. If this sometimes does not happen, it may be due to inexperience, but even so this phenomenon can be detected when the impact occurs on a rib on dihedral butts, and consequently these flakes can be classed as indeterminate and eliminated.

During the process of lithic reduction, the hammerstone strikes the percussion platform violently. As a result of the impact, a series of cracks usually form around the point of percussion and these are preserved in the flake butt. These fractures, called parabolic cracks, are in the shape of a parabola whose axis of symmetry is aligned depending on the percussion direction. Since left-handed and right-handed people striking the same point in a core



hit from opposite directions, and the cracks are recorded in the flake butt, the knapper's handedness can be determined with a high degree of reliability. This method bases its observations on a physical process related to the behaviour of the raw material and, therefore, the results are subject to the physical behaviour of the most usual material in the lithic assemblages of prehistoric hunter-gatherer groups. In addition, the knapper's handedness can be determined in every flake produced, without needing several flakes that are definitely known to have been extracted by the same individual. These circumstances mean that a larger number of remains are susceptible to being studied, and the sizes of the samples can be increased to reach quantifiable and statistically significant numbers. This method can be applied to any flake, independent of the technique that has been used to remove it. Although it may be similar, the production of parabolic cracks in blades and bladelets has not been tested in this work. Since the precision of the method and its great potential for application have been proved experimentally, the handedness index can be calculated quantitatively and statistically for prehistoric communities, both for our own species and for previous human species, such as Neanderthals, based on the observation of this variable in lithic assemblages made from flint.

### **3.4 Sample Size**

The main objective of this thesis is to know the population levels of laterality in farming and hunter-gatherer prehistoric societies. If we want to study a population that we don't have access to all of its individuals, and we want to know the proportion of those who achieve a certain condition, we have to study a sample of this population. This sample should represent the global population. In the case of this thesis we want to know the proportion of individuals who achieve the condition of been right-handed (or left-handed) within a population that has disappeared entirely. Once developed the methodology necessary to infer laterality from a flake we need to know how many of them we should study to establish the laterality of the population that produced this flakes. First we have to assume that each individual contribute with an a unique flake to the record, although we understand that certainly the same knapper can contribute with several flakes to an archaeological assemblage.

ge, this phenomenon would only mean a real problem in the case of levels of workshop that have been accumulated in a reduced time interval.

To calculate the minimum sample size that is representative of a population we need to know several factors:

- Population size: If the exact size of the population is not known, it is considered “infinite” (> 10000).
- Estimated proportion: is an estimation of the proportion we expect to find.
- Margin of error: interval in which we hope to find the data that we want to measure of the population.
- Confidence intervals: the certainty that really the data we are searching for is within the margin of error.

#### 3.4.1 Population size

In the case of this thesis, we do not know the size of the population, therefore we have to consider that our population is “infinite” (> 10000), which is what requires a larger sample size.

#### 3.4.2 Estimated proportion

Normally in studies where you have access to the population being studied, an exploratory study is performed to obtain preliminary data and calculate the required sample size. This is because the minimum size of a representative sample of a population to measure a quality that is present, for example, 10% of the population, is less than that sample size required to measure a quality that is present in only 0.01%, for example. To calculate the appropriate sample size is not necessary to know the exact proportion (obviously if we knew the exact proportion we do not need to do the study), to have a rough estimate is sufficient.

In our case we can make an estimate from the studies that have been made in modern

societies. First, obviously, no population can have a higher proportion of right-handed people than 100%. We also know that none of the populations studied currently has the largest number of left-handers than right-handers, so it is reasonable in principle to limit the expected ratio between 50% and 100% of right-handers. In addition, as we have detailed in chapter 2, we have some specific studies in non-industrialized societies, whose levels of laterality may resemble more that could be found in the non-industrialized prehistoric societies that we want to study. These works are detailed in the following table.

	L	R
Papua New Guinea	19,6	80,4
Papua New Guinea	15	85
Côte d'Ivoire	22	78
Botswana (G /wi San tribe)	15	85
Namibia (Himba tribe)	21	79
Venezuela (Yanomamo tribe)	16	84
Gabon (Baka tribe)	10,2	89,8
Burkina Faso (Bobo-Dioulasso)	6,35	93,65
Indonesia (tribu Eipo)	26,9	73,1

Table 3.9 Proportion of left and right-handers of different countries.

Looking at the data shown in Table 3.9 we can set a range of right-handed people proportion between 73.1% and 89.8% for non-industrialized populations. In the study conducted in Burkina Faso 93.65% of right-handers among men and 100% among women skilled was detected. Because of the difficulty of interpreting these values, we have chosen to leave this study out of the sample size calculation. The central value of this range is 81.5%, so we can establish as an estimate that the proportion of right-handed people in a prehistoric population will be around this value.

	Maximum	Minimum	Median
Not westernized societies	89,9	73,1	81,5

Table 3.10 The maximum, minimum and the median proportions (%) of right-handers in not westernized societies.

### 3.4.3 Margin of error and Confidence intervals

These two parameters are closely related and can be calculated from the distribution of values around the estimated proportion. It is assumed that the distribution of these values

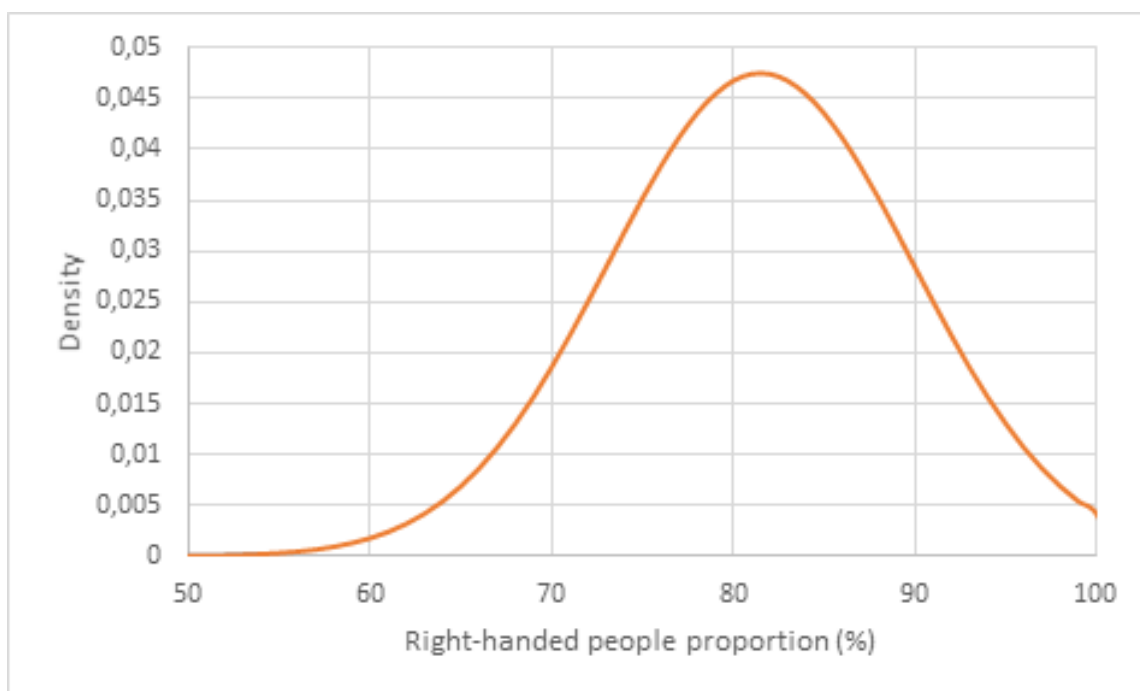

Figure 3.28 Gaussian distribution of right-handed people proportion in not westernized populations

is normal and as such can be represented by a Gaussian function. This curve is theoretical, the real values are not strictly distributed normally, but can be approximated much to it. This means that the proportion of right-handed people more likely in a not westernized population is 81.5% and gradually decreases to unlikely right-handed people proportions as 89.8% and 73.1% and not expected ratios of right-handed people as > 100% and <50% (figure 3.28). Between 65% and 98% it is concentrated to 95% of probability. Which means that the confidence interval is 95% and the margin of error is 16.5%.

#### 3.4.4 Conclusion

After obtaining these data we can proceed to the calculation of sample size. We consider that the size of the study population is infinite (> 10000), the estimated proportion of right-hander people is 81.5% (estimated from previous studies), the confidence interval is 95% and the margin error is 16.5%. The equation that determines us the sample size for infinite populations is as follows:

$$n = \frac{Z^2 p q}{e^2}$$

Where “n” is the minimum size of the representative sample, “Z” is a value that represents the confidence interval (1.96 corresponds to 95%), “p” is the estimated proportion (0.815

in this case), “q” is “1 - p” (0.185 in this case) and “e” is the margin of error (0.165 in this case). In this case the minimum size of the representative sample of the population is  $n = 21,85$ .

**Capítulo 4:**

# **Materiales y Resultados**





## **4.1 Introducción**

Durante la Prehistoria han sido varias las especies humanas que han ido produciendo restos culturales. A la hora de elegir los materiales adecuados para estudiar los niveles poblacionales de lateralidad en estas sociedades pasadas hay que tener en cuenta varias cuestiones. En primer lugar, tenemos que conocer los ratios de lateralidad en sociedades formadas por miembros de nuestra misma especie para controlar el factor cultural. Como hemos comentado en el capítulo 2, existen numerosos trabajos sobre diferentes sociedades actuales, tanto industrializadas como no industrializadas (Faurie y Raymond, 2013; Faurie et al., 2005; Holder y Kateeba, 2004; Marchant et al., 1995; McManus, 2009; Raymond y Pontier, 2004), por lo que la variabilidad geográfica actual de la lateralidad se conoce bastante bien. Es interesante, por lo tanto, estudiar las sociedades prehistóricas formadas por miembros de nuestra misma especie y compararlos con las actuales (Dominguez-Ballesteros y Arrizabalaga, 2014), ya que estamos comparando grupos de individuos de genética muy similar, y por lo tanto el factor especie no actuará como variable. Por ello, en este capítulo se estudiarán, en primer lugar, materiales arqueológicos de sociedades productoras, calcolíticas y neolíticas, con el objetivo de comprender como varían los niveles poblacionales de lateralidad respecto de los actuales. Una vez comprendido cómo influyen los factores no genéticos en los niveles de lateralidad, podremos estudiar grupos de individuos de otra especie. Por ello, en segundo lugar, en este capítulo analizamos restos arqueológicos del Paleolítico, producidos por sociedades cazadoras-recolectoras, en este caso formadas por individuos de diferente especie a la nuestra.

En primer lugar, nuestro planteamiento parte del estudio bibliográfico de la lateralidad en sociedades industrializadas actuales, para comprender cómo son los niveles de lateralidad en las diferentes poblaciones actuales, reflejado en el capítulo 2 de esta tesis. Posteriormente, hemos desarrollado un método, detallado en el capítulo 3, para establecer los niveles de lateralidad poblacional en sociedades productoras y de esta manera comprender cómo afecta el factor cultural y el nivel de industrialización en este fenómeno, completándolo con el estudio bibliográfico de sociedades actuales no industrializadas. Finalmente, una vez com-

prendido cómo afectan estos factores culturales, hemos desarrollado un método, detallado en el capítulo 3, para establecer los niveles poblacionales de lateralidad en poblaciones de cazadores-recolectores formadas por *Homo neanderthalensis*, y comprender de esta manera como ha surgido y cómo ha evolucionado el fenómeno de la lateralidad en nuestra propia línea evolutiva. En este capítulo 4 se presentan los materiales arqueológicos que se han estudiado para establecer los niveles poblacionales de lateralidad en poblaciones productoras del neolítico-calcolíticas y de sociedades cazadoras-recolectoras del Paleolítico Medio, y los resultados obtenidos a partir de dicho estudio. Los materiales del Paleolítico Medio que hemos estudiados provienen concretamente de los niveles I y J de Le Moustier, del nivel VII de Grotte Vaufrey y de los niveles III, IV, V, VI, VII y VIII de Axlor. Teniendo en cuenta la cronología de estos niveles y el análisis cultural de sus industrias líticas, podemos determinar que no fueron producidas por individuos de nuestra misma especie y que fueron producidas por la especie *Homo neanderthalensis*.

## **4.2 Materiales**

En este apartado detallamos los materiales que se han estudiado en esta tesis agrupados en dos grupos, por una parte los materiales del Neolítico y Calcolítico de Bizkaia, Álava y Navarra, y por otro lado los materiales del Paleolíticos de Le Moustier, Vaufrey y Axlor.

### **4.2.1 Neolítico y Calcolítico**

Los materiales arqueológicos idóneos para ser estudiados desde el punto de vista de la lateralidad tienen que presentarse en el registro de manera abundante, ya que no queremos conocer la lateralidad de un único individuo, sino que queremos obtener los ratios de zurdos y diestros a nivel poblacional. Por lo tanto, para el Neolítico y Calcolítico hemos optado por estudiar los útiles pulimentados. Estos instrumentos estaban muy extendidos durante estos periodos y son abundantes en el registro arqueológico. Para este trabajo hemos optado por estudiar principalmente los restos de las provincias de Bizkaia y Álava, territorios en los que se han recuperado numerosos restos de este tipo.



Figura 4.1 Localización de los yacimientos de Bizkaia, Álava y Navarra (Los Cascajos) donde se han hallado los útiles pulimentados.

Hemos analizado diversos útiles pulimentados de yacimientos neolíticos y calcolíticos ubicados principalmente dentro de la Comunidad Autónoma Vasca. En la provincia de Bizkaia: Larraskitu (Bilbao), Lacilla II (Sopuerta), Berreaga (Mungia), Baltzola (Dima), Picos Ramos (Muskiz), Ajangiz, Hirimugarrieta II (Artxanda), Los Zorros (Zierbana), Maieskune (Ereño), Ollagorta (Barrika), Galupa I (Karrantza), Kobeaga I (Ispaster) y Ereñuko Arizti II (Ereño); En la provincia de Álava y Treviño: Embalse de Urrunaga (Legutiano), La Dehesa de San Bartolomé (Berrostegieta), El Huerto (Pipaón), Las Canteras (Burgueta), Finca Ma-

roto (Cucho), Beraza (Ezkerekotxa), La Llosa (Leciñana), San Martín (Elvillar), El Llano (Espejo), Salas (Valdegovia), Campo de los palacios (Vitoria-Gasteiz), Zumeltzu (Vitoria-Gasteiz) y Mizkiartes (Araia); y ubicados fuera de la Comunidad Autónoma Vasca: Los Cascajos (Navarra); y otro de Álava pero de procedencia desconocida (Figura 4.1; Estavillo, 1975; Fernández Eraso, Sáenz de Buruaga Blázquez, & Vegas Aramburu, 1987; Fernández Eraso et al., 2003; Ortiz & Lobo, 1980; Ortiz & Diaz-Empananza, 1988; Rato, 1966).

#### 4.2.1.1 Bizkaia

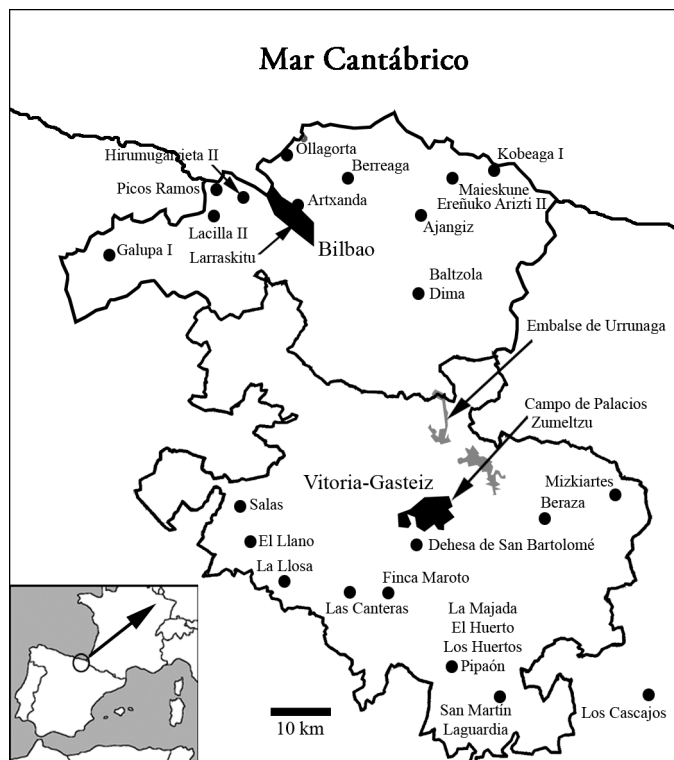
La provincia de Bizkaia se encuentra al norte de la Península Ibérica y es uno de los tres territorios de la comunidad autónoma vasca, en el estado español. Hace frontera al oeste con la comunidad autónoma de Cantabria, al sur con Álava, al este con Gipuzkoa y al norte con el Mar Cantábrico.

En Bizkaia, el yacimiento del que se han estudiado mayor número de restos (10) es el de Pico Ramos, en Muskiz. La cueva fue localizada en 1989 por miembros de Harribaltzaga Kultur Elkarte y fue excavada durante los años 1990, 1991 y 1992 por Lydia Zapata. Esta cueva, que se utilizó con fines sepulcrales, cuenta con una tumba múltiple (N.M.I. = 104), en la que se dan inhumaciones primarias colectivas por acumulación de restos humanos., junto a los cuales aparecen numerosos útiles y elementos de adorno (Zapata, 1995).

El resto de hachas estudiadas han sido recuperadas en diversos contextos y diferentes puntos de la geografía vizcaína.

Del yacimiento de Baltzola, en el municipio de Dima, que fue excavado por Galvez Cañero en 1913, por J. M. Barandiarán en 1932 y por el Seminario de Arqueología de la Universidad de Deusto en 1980, proceden tres de las hachas estudiadas, de cronología neolítica, que se encuentran depositadas en el Museo Arqueológico de Bilbao.

En Mungia, fue hallada otra de las hachas estudiadas, en el Monte Berreaga (Mungia, Bizkaia). Jose Luis Arribas y Eduardo Berganza analizan y describen la pieza (Arribas y Berganza, 1984).

Otra de las hachas estudiadas fue hallada en el dolmen de Hirimugarrieta II, que se encuentra situado a 376 metros de altitud, entre los montes Avril y Ganguren, en la estribación montañosa de Artxanda. Este monumento, junto con los dólmenes Hirimugarrieta I y Hirimugarrieta III, pertenece a la necrópolis dolménica de Hirimugarrieta del Este de Artxanda (Zubizarreta, 1995). Fue descubierto por J. Sarachaga en 1966 y posteriormente se realizaron varias campañas de excavación bajo la dirección de Inmaculada Martín y Arantza Zubizarreta entre 1990 y 1993 (Martín y Zubizarreta, 1990).

De la cueva de Los Zorros, que se encuentra en la vertiente meridional del cabo Punta Lucero, en Zierbena, proviene otra de las hachas estudiadas. El hallazgo consiste en diversos restos humanos, tanto de adultos como infantiles, de numerosos restos de sílex y el hacha

mencionada anteriormente. Se cree que la cueva puede ser utilizada con fines sepulcrales y que los restos recuperados tuvieran una función simbólica (Ayuntamiento de Abanto-Zierbena, 2013).

Seis de las hachas estudiadas provienen de la cueva de Lacilla, que se encuentra en el municipio de Sopuerta, y consiste en una cavidad que presenta una pequeña boca de 1,2 metros. A 40 metros de la entrada se encuentra el yacimiento sepulcral. Fue descubierto en 1980 por el Grupo Espeleológico Vizcaíno. La necrópolis se atribuye al Bronce final (Marcos Muñoz y Muñoz Salvatierra, 1984; Marcos Muñoz, 1982).

Otra de las hachas fue hallada en el término municipal de Ereñu, junto al caserío Maieskune. El hallazgo lo realizó Raimundo Oar, vecino del municipio, el 15 de mayo de 1987. Este hallazgo fue publicado en un informe (López Quintana, 2015). Cerca del yacimiento de Ollagorta, descubierto por J.M. de Barandiarán en 1959, se ha encontrado numeroso material arqueológico en superficie, como es el caso de otra de las hachas estudiadas. Este yacimiento se encuentra en el municipio de Barrika, sobre una suave vaguada sobre los acantilados costeros (Regalado Bueno, 2011).

Proveniente del dolmen de Galupa I, situado en el término municipal de Turcios, se ha estudiado un hacha pulimentada, perteneciente a un ajuar encontrado en el túmulo (Apellániz, 1965). Este yacimiento fue descubierto por Pedro María y Pedro Julián Gorrochategui en 1960. Forma parte de la estación megalítica de Turcios-Carranza y fue excavado por Juan María Apellaniz e Ignacio Amezua en 1965. Se trata de un dolmen simple, construido en medio de un túmulo circular de 15 metros de diámetro.

También se ha estudiado un hacha de la cueva sepulcral de Kobeaga I, que se encuentra en el segmento de costa que une Bermeo y Mutriku, tramo de alta concentración de este tipo de yacimientos, concretamente a la altura del término municipal de Ispaster. La cueva fue descubierta en 1963 por Ernesto Nolte y Aramburu (Nolte y Aramburu, 1963). Durante las excavaciones llevadas a cabo por Ernesto Nolte y Aramburu y Juan María Apellaniz

durante 1964 y 1965 se encontró, en la base de un estrato fértil, un ajuar al cual pertenece el hacha estudiada en este trabajo (Apellániz y Nolte y Aramburu, 1965).

Otra de las hachas de las estudiadas fue encontrada en Larraskitu (Bilbao) y procede de las cercanías de la subestación de Iberduero de esta misma localidad (Nolte y Aramburu, 1985).

En la necrópolis de la cueva de Ereñuko Arizti, en el término municipal de Ereño se encontró otra de las hachas que se han incluido en este capítulo. El yacimiento fue estudiado por J.M. Apellaniz (Apellániz, 1971).

También se ha estudiado un hacha cuya procedencia es el municipio de Dima (sin especificar) y otra de Ajangiz (tabla 4.1).

<b>Yacimiento</b>	<b>Localización</b>	<b>Número de hachas</b>
Ajangiz	Bizkaia	1
Baltzola	Bizkaia	3
Berreaga	Bizkaia	2
Dima	Bizkaia	1
Ereinuko Arizti II	Bizkaia	1
Galupa I	Bizkaia	1
Hirumugarrieta II	Bizkaia	1
Kobeaga I	Bizkaia	1
Lacilla	Bizkaia	6
Larraskitu	Bizkaia	1
Los Zorros	Bizkaia	1
Maieskune	Bizkaia	1
Ollagorta	Bizkaia	1
Pico Ramos	Bizkaia	10

Tabla 4.1 Número de hachas prehistóricas estudiadas en cada yacimiento de Bizkaia.

#### 4.2.1.2 Álava, Treviño y Navarra

La provincia de Álava se encuentra al sur de la provincia de Bizkaia, también en la Comunidad Autónoma del País Vasco. Limita al oeste con la provincia de Burgos de la comunidad autónoma de Castilla y León, al sur con la comunidad autónoma de La Rioja, al este con la Comunidad Foral de Navarra y al norte, además de con Bizkaia, con la provincia de Gipuzkoa. La Comunidad Foral de Navarra, a su vez, limita al oeste con la comunidad autónoma vasca, al sur con La Rioja y al este con la comunidad autónoma de Zaragoza.

El yacimiento del que hemos estudiado más útiles (24) fue el Embalse de Urrunaga (Álava). Estos materiales forman un conjunto relativamente amplio y homogéneo, hallado en un ámbito geográfico no muy extenso y bien delimitado (Fernández Eraso et al., 2003). Otro yacimiento del que estudiamos numerosos útiles (14) fue la Dehesa de San Bartolomé en Berrosteguieta, Álava (Llanos, 2005). Fue descubierto en 1870 por J.J. Ugarte y formaba parte de un conjunto que podría corresponder con lo que sería un hábitat al aire libre. Según Ugarte, una prueba de ello es la indicación de que todo el material lítico se localizó reunido, en una situación a una cierta altura sobre el valle.

El resto de hachas estudiadas han sido halladas en diversos contextos en diferentes puntos de la geografía alavesa.

Una de ellas proviene del yacimiento de Campo Palacios, ubicado en el término municipal de Vitoria-Gasteiz y descubierto por Domingo Fernández Medrano. Esta hacha fue adscrita al Calcolítico-Bronce y fue depositada en el Museo Provincial de Arqueología de Álava en 1945.

El yacimiento de Bereaza se encuentra en el término municipal de Iruraiz-Gauna, y de él proviene otra de las hachas estudiadas. Este yacimiento, que se engloba en el periodo cultural Calcolítico-Bronce, fue descubierto en 1975 por Julio Sáez de Vicuña.

Del yacimiento de El Huerto, que se encuentra en el término municipal de Pipaón y que fue descubierto por Pilar Alonso, procede otra de las hachas estudiadas, también adscrita al Calcolítico-Bronce.

El yacimiento de El Llano consiste en un lugar de habitación hallado en el término municipal de Valdegovía y fue descubierto por Félix Murga en 1982. De este yacimiento procede una de las hachas estudiadas. Esta hacha se encontró junto con material cerámico (Terra Sigillata,...), por lo que ha sido englobada dentro del periodo de romanización.

Otra de las hachas estudiada en esta sección fue encontrada en el yacimiento de Finca Maroto, situado en el término municipal de Treviño, y fue descubierto por el propio propietario de la finca, Santos Maroto, en 1979. Se trata de un hallazgo aislado, en una zona de gravas que se encuentra cubierta por una capa vegetal de unos 40 centímetros, junto al río Ayuda. Al realizar unas obras se detectó un paquete de sedimento más oscuro, donde se encontró la citada hacha, junto con material cerámico y una laminilla, algunas lascas y trozos de sílex. Fue excavado por José Ignacio Vegas y ha sido adscrita al periodo cultural Calcolítico (Vegas, 1981).

Del yacimiento de La Llosa, que se trata de un lugar de habitación de un poblado fortificado y que se encuentra dentro del término municipal de Ribera Alta, proviene otra de las hachas estudiadas. El yacimiento consiste en una plataforma de escasa elevación junto al río Zadorra. Fue descubierto en 1973 por Juan Antonio Madinabeitia. El hacha estudiada proviene, como el resto de materiales recuperados de este yacimiento, de prospecciones superficiales. Además se hallaron materiales líticos de sílex y cerámicos. La cronología en la que se engloban estos materiales es el Calcolítico (Vegas, 1978).

Otra de las hachas estudiadas en esta sección fue encontrada, junto con algunos restos de sílex, en el yacimiento de La Majada, en el término municipal de Pipaón. El yacimiento fue descubierto por J. M. González en 1983. El periodo cultural al que se adscriben estos restos es el Calcolítico-Bronce .



El yacimiento de Las Canteras está situado en el término municipal de Treviño. Este yacimiento, del que se han estudiado dos hachas pulidas, consiste en un lugar de habitación al aire libre cerca del río Zadorra. Fue descubierto en 1972 por Juan Antonio Madinabeitia y en 1979 el Instituto Alavés de Arqueología realizó un sondeo estratigráfico. Junto a las dos hachas pulidas aparecieron restos de sílex, de fauna, metálicos y cerámicos. Los materiales fueron descritos como pertenecientes al periodo cultural del Calcolítico-Bronce.

Del yacimiento de Los Huertos procede otra de las hachas estudiadas en esta tesis, y consiste en un yacimiento que se encuentra en el término municipal de Pipaón y fue descubierto por Pilar Alonso. El hacha fue adscrita a una cronología de Calcolítico-Bronce.

El yacimiento de Mizkiartes, del que proviene otra de las hachas estudiadas, está ubicado en término municipal de Asparrena. Los restos encontrados se han englobado dentro de una cronología del Calcolítico-Bronce y pertenecen al inventario de Domingo Fernández Medrano.

Del yacimiento de Salas, situado en el municipio de Valdegovía, se ha estudiado un hacha. Fue descubierto por Félix Murga en 1983 y junto al hacha se encontró material cerámico y útiles de sílex.

El yacimiento de San Martín se encuentra en el municipio de Elvillar y consiste en una zona de habitación al aire libre. De este yacimiento hemos estudiado dos hachas que aparecieron junto a otros restos de sílex y de cerámica. El emplazamiento se encuentra a 700 metros del dolmen de La Hechicera y fue descubierto por José Javier López de Ocariz en 1977.

Otra de las hachas estudiadas en esta tesis proviene del yacimiento de Zumeltzu, que se encuentra situado en el término municipal de Vitoria-Gasteiz y fue descubierto por Juan Antonio Madinabeitia. Consiste en un lugar de habitación al aire libre.

También se ha estudiado otra hacha hallada en el término municipal de Pipaón, otra en

Gasteiz, otra en Paso Maenillo, otra en El Espinal y otras 9 de origen desconocido. Todas las hachas mencionadas en este apartado fueron depositadas en el Museo BIBAT de Vitoria-Gasteiz (tabla 4.2).

<b>Yacimiento</b>	<b>Localización</b>	<b>Numero de hachas</b>
Beraza	Álava	1
Campo de los Palacios	Álava	1
Dehesa de San Bartolomé	Álava	14
El Espinal	Álava	1
El Huerto	Álava	1
El Llano	Álava	1
Embalse de Urrunaga	Álava	24
Finca Maroto	Álava	1
Gasteiz	Álava	1
La Llosa	Álava	1
La Majada	Álava	1
Laguardia	Álava	1
Las Canteras	Álava	2
Los Cascajos	Navarra	2
Los Huertos	Álava	1
Mizkiartes	Álava	1
Paso Maenillo	Álava	1
Pipaón	Álava	1
Salas	Álava	1
San Martin	Álava	2
Zumeltzu	Álava	1
Origen desconocido	Álava	9

Tabla 4.2 Número de hachas prehistóricas estudiadas en cada yacimiento de Álava y Navarra.

#### 4.2.2 Paleolítico

En el caso de los restos arqueológicos paleolíticos, el elemento mejor representado en el registro lítico, y que, por lo tanto, permite el disponer de una muestra mayor, es la lasca. Además, puede ser analizada, desde el punto de vista de la lateralidad, tanto si la encontramos como resto de talla, como si ha sido retocada y constituye un útil, siempre y cuando este preservado el talón, como hemos detallado en el capítulo 4. Esto, unido a que la lasca está presente en el registro arqueológico durante todo el Paleolítico, nos permite evaluar los niveles poblacionales de lateralidad a partir de una muestra suficientemente amplia para cualquier momento de este periodo.

Con el objetivo de comprobar el funcionamiento del método desarrollado en esta tesis y aplicarlo a materiales arqueológicos, se han estudiado los niveles I y J del yacimiento del Abrigo de Le Moustier, como se detallará más adelante. Estos dos niveles arqueológicos cumplen con las condiciones necesarias para realizar un estudio de la lateralidad de los grupos humanos que los produjeron. Por un lado, estos niveles cuentan con un alto número de restos que conservan el talón, tanto restos de talla y lascas sin retocar, como útiles sobre lasca. Además, el buen estado de conservación de los talones de estos materiales permite observar las fracturas parabólicas (FP) adecuadamente, incluso en el caso del nivel I que, como comentaremos más adelante, ha sufrido abrasión en sus aristas y bordes.

También hemos estudiado el nivel VII de Grotte Vaufray. Este nivel cuenta con numerosos restos arqueológicos en los que se puede aplicar la metodología descrita en esta tesis, aunque en menor número de los que se presentan en los niveles I y J de Le Moustier. Este nivel se estudió con el objetivo de comprobar el funcionamiento de la metodología en otros materiales, de distinta procedencia y de edad sensiblemente más antigua (200.000 años) que los de Le Moustier (40.000 años). En este caso, los materiales también se encuentran en muy buen estado de conservación, como se detallará más adelante, y se presentan como una colección adecuada para observar las fracturas parabólicas.

Por último hemos analizado los niveles 0, I, II, III, IV, V, VI, VII y VIII de las excavaciones de J. M. de Barandiarán en Axlor. Estos niveles cuentan con numerosos restos susceptibles de ser analizados mediante la metodología descrita en esta tesis a pesar de que el nivel de conservación de los materiales no es tan bueno como en el caso de Le Moustier o Grotte Vaufrey. El objetivo de analizar estos niveles fue el de aplicar esta metodología en una secuencia completa, en todos los niveles de un mismo yacimiento.

#### 4.2.2.1 Le Moustier

El yacimiento se encuentra situado en la región francesa de la Dordoña, dentro del término municipal de Peyzac-le-Moustier, en la margen derecha del río Vézère cerca de su intersección con el río Vimont (figura 4.2).



Figura 4.2 Localización del yacimiento del abrigo de Le Moustier. (Tomado de Maureille, 2002).

Consiste en dos abrigos, separados entre sí por 14 metros, uno superior (llamado Le Moustier I), el clásico, y otro inferior (Le Moustier II), descubierto posteriormente.

El abrigo superior fue excavado inicialmente por E. Lartet y H. Christy en 1863. Los abundantes materiales líticos que descubrieron fueron posteriormente, en 1869,

bautizados como “musteriense” por Gabriel de Mortillet. Más adelante, las excavaciones en el abrigo superior fueron llevadas a cabo por M. Bourlon y D. Peyrony.

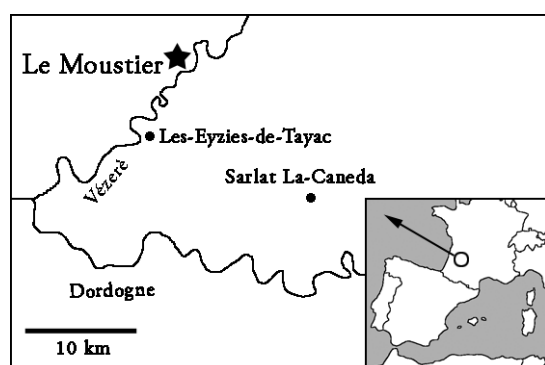
En 1907 O. Hauser comienza a excavar el abrigo inferior, hasta 1910. A partir de entonces D. Peyrony, en 1912, 1913, 1914 y 1930 continuó con las excavaciones, y como resultado de su trabajo, publicó en 1930 una monografía donde estableció la estratigrafía y definió las culturas prehistóricas presentes. Posteriormente, en 1937 y 1947, M. Bourgon atribuye a algunos niveles cronologías diferentes a las propuestas por Peyrony y propone llamar al yacimiento “Abri Peyrony”. En 1948 F. Bordes estudia el material lítico y junto con

E. Bonifay restaura en 1956 los niveles deteriorados a consecuencia de una inundación. En 1969 Laville y Rigaud restauran nuevamente esos mismos perfiles, lo que permite la realización de un nuevo perfil estratigráfico (Turq y Maureille, 2005), asociando los niveles H, I y J (figura 4.3) al estadio isotópico 3. Concretamente, el nivel J supondría una variación fría y seca (Laville y Rigaud, 1973). Más adelante, en 1982, H. Laville y J. Ph. Rigaud restauran el perfil del testigo dejado por Peyrony, lo que permite nuevos análisis granulométricos y



Figura 4.3 Secuencia estratigráfica del abrigo de Le Moustier (Tomado de Soressi, 1999).

sedimentológicos que sacan a la luz una superficie de erosión sobre la capa G. Este descubrimiento modificó la correlación crono-ambiental de los distintos niveles arqueológicos. También en 1982, J. M. Geneste y J. P. Chadelle excavan una pequeña superficie (30x40 centímetros) que permite realizar análisis de termoluminiscencia a partir de sílex quemado para obtener dataciones absolutas de los niveles G, H, I, J y K (Valladas et al., 1986). Más adelante, Mellars y Grün (1991) realizan también análisis de resonancia paramagnética electrónica obteniendo resultados coherentes con los obtenidos en 1986. Finalmente, en 1992 el perfil se protege mediante unos muros de piedra y se realizan en 1994 unos moldes en los que queda preservada la estratigrafía.

En el abrigo de Le Moustier se han hallado varios restos neandertales. Entre estos restos destacaremos, por estar relacionados con los niveles estudiados en el presente trabajo, por un lado, el esqueleto descubierto en 1908 por O. Hauser, parcialmente dañado durante la Segunda Guerra Mundial (Hauser, 1909; Maureille, 2002; Turq y Maureille, 2005; Vandermeersch, 1971), y, por otro lado, el descubierto en 1914 por Peyrony, del cual solo publica una pequeña descripción en 1921 (Peyrony, 1921). Los encontrados en 1908 se conocen como Le Moustier 1 y en un principio Hauser (Hauser, 1909) los relacionó con el Achelense (Maureille,

2002). Pero posteriormente Bordes los asocio al nivel J (Bordes, 1959), estudiado en este apartado. Los restos encontrados en 1914 fueron descubiertos por D. Peyrony en una fosa y se identificaron como Le Moustier 2 (Maureille, 2002; Vandermeersch, 1971). Esta fosa estaba excavada desde el nivel arqueológico J, cruza todo el nivel I y parte del nivel H. Según Peyrony sus límites son claros (Maureille, 2002; Peyrony, 1921) y contenía los restos de un niño pequeño y varios objetos musterienses. La forma de la fosa es de un cono truncado, de 40 cm de profundidad y un diámetro de 50 cm. (Maureille, 2002; Turq y Maureille, 2005).

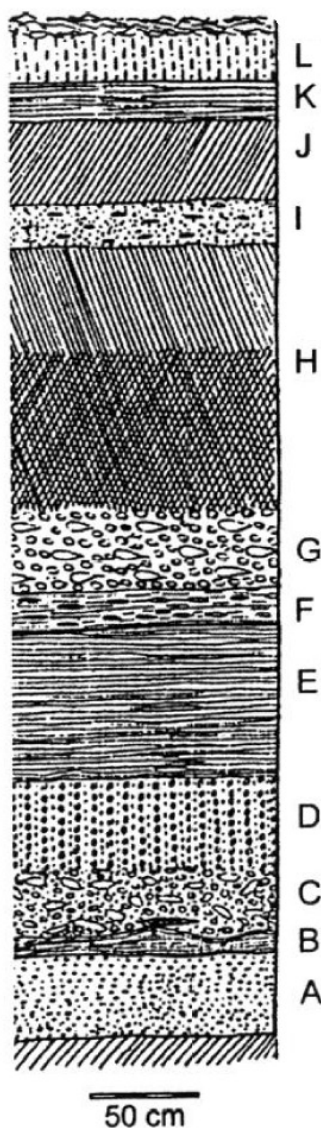
Los materiales arqueológicos que se han estudiado de este yacimiento provienen de los niveles I y J. Estos niveles cuentan con numerosos restos susceptibles de ser analizados desde el punto de vista de la lateralidad y, tanto por su antigüedad (aproximadamente 40.000 años), como por el periodo cultural al que pertenecen (Musteriense), podemos afirmar que fueron realizados por *Homo neanderthalensis*. Por tanto, estos niveles cumplen las condiciones necesarias para estudiar los niveles poblacionales de la lateralidad en esta especie.

#### Nivel I

En 1930 D. Peyrony describió este nivel como un estrato de 20 centímetros de espesor. Según él, estaba formado por unas arenas fluviales mezcladas con los materiales de superficie de la capa precedente (figura 4.3). Esta capa se pudo formar por una fuerte crecida del río Vézère, y los materiales que contiene están ligeramente pulidos por la abrasión con la arena. Se trata de un conglomerado, siempre según Peyrony, de la segunda terraza, que no es un aporte del río, sino un nivel arqueológico musteriense correspondiente al nivel H de la capa inferior, lavado y rodado en parte, o bien por una corriente de flujo y reflujo, o bien por una corriente turbulenta (Peyrony, 1930).

Según Peyrony, el nivel de la Vézère en su estiaje mínimo es de 62 metros de altitud en el lado de Le Moustier. Existe una diferencia de 21 metros entre este nivel y la superficie de conglomerados, que se ubica a 83 metros de altitud. La segunda terraza se sitúa a 82 metros de altitud. La corriente llegó, sin duda, a más altura para producir el efecto mecánico obser-

vado (Peyrony, 1930).

El Abrigo de Le Moustier se encuentran en el extremo de un promontorio rocoso formado por la intersección de los valles de la Vézère y el Plazac (Peyrony, 1930). En ese lugar, según este autor, se producirían turbulencias fuertes y flujos y reflujos que arrastrarían el sedimento, los carbones, las cenizas y los huesos del nivel arqueológico inundado, haciendo que chocaran, sin demasiado desplazamiento, los materiales más pesados (sílex y piedras calizas), cuyas aristas y ángulos están redondeados. Este pulido, según Peyrony, está producido por la abrasión de los materiales debido a las aguas salvajes. A pesar de este redondeamiento, los materiales presentan un nivel excelente de conservación en el talón, con escasa presencia de pátinas, lo que permite observar adecuadamente las fracturas parabólicas. Al estudiar las industrias de ambas terrazas, Peyrony deduce que han sido ocupadas simultáneamente por tribus que tienen un utillaje idéntico, las cuales se volvieron a ocupar por tribus igualmente musterienses pero que poseían una industria de aspecto totalmente diferente (Peyrony, 1930). Según las dataciones realizadas en 1982 por Geneste y Chadelle, este nivel tendría una antigüedad de  $40.900 \pm 5000$  años (Valladas et al., 1986).

Para el estudio de las parabolic crack, de este nivel se han estudiado un total de 1499 restos, de los cuales 38 (2,5% del total) fueron rechazados por carecer de talón, elemento sobre el que se desarrollan este tipo de fracturas. El 97,4% restante, 1461, fueron considerados susceptibles de presentar fracturas parabólicas. Entre los restos que presentaban talón, el 84,4% de estos restos no presentaban este tipo de fracturas. El 15,6% restante, 228 elementos, sí presentaban estas fracturas y fueron analizados, medida la dirección de las parabolic crack y clasificados según los tipos L y R definidos en el capítulo de metodología. Los detalles se muestran en la siguiente tabla 4.3.



<b>Total:</b>	1499
<b>Lascas sin talón:</b>	38 (2,5% del total)
<b>Lascas con talón:</b>	1461 (97,5% del total)
<b>Lascas sin FP:</b>	1234 (84,4% de los elementos con talón)
<b>Lascas con FP:</b>	228 (15,6% de los elementos con talón)

Tabla. 4.3 Detalle de los materiales estudiados en el nivel I de Le Moustier.

## Nivel J

Este nivel es descrito por Peyrony como un estrato de 40 centímetros de espesor, de color marrón, y según él lo integran un gran número de lascas no utilizadas y de utillaje retocado del tipo de los de La Quina y de La Ferrassie (figura 4.3). Esta industria se compone de bifaces cordiformes, de puntas triangulares bastante grandes algunas rectas, utilizadas según Peyrony como armaduras, y otras arqueadas, que son verdaderos cuchillos según el autor (Peyrony, 1930).

Sobre este nivel, que considera en posición primaria, sin remoción, Peyrony también aporta información sobre la fauna encontrada, documentando la abundancia de restos de grandes bóvidos y de algún cérvido, équido y reno en la base, y de abundancia de caballo y reno y pocos restos de cérvidos y bóvidos en la parte superior. Según Peyrony, este cambio de la fauna de base a techo sería el reflejo de un cambio climático (Peyrony, 1930). Según las dataciones realizadas en 1982 por Geneste y Chadelle, este nivel tendría una antigüedad de  $40.300 \pm 2600$  años (Valladas et al., 1986).

Para el estudio de las fracturas parabólicas, de este nivel, hemos estudiado un total de 1493 restos, de los cuales 195 (13,1% del total) fueron rechazados por carecer de talón,



elemento sobre el que se desarrollan este tipo de fracturas. El 86,9% restante, 1298, fueron considerados susceptibles de presentar fracturas parabólicas. Entre los restos que presentaban talón, el 85,8% de estos restos no presentaban este tipo de fracturas. El 14,2% restante, 184 elementos, sí presentaban estas fracturas y fueron analizados, medida la dirección de las parabolic crack y clasificados según los tipos L y R definidos en el capítulo de metodología. Los detalles se muestran en la siguiente tabla 4.4.

<b>Total:</b>	1493
<b>Lascas sin talón:</b>	195 (13,1% del total)
<b>Lascas con talón:</b>	1298 (86,9% del total)
<b>Lascas sin FP:</b>	1114 (85,8% de los elementos con talón)
<b>Lascas con FP:</b>	184 (14,2% de los elementos con talón)

Tabla. 4.4 Detalle de los materiales estudiados en el nivel J de Le Moustier.

#### 4.2.2.2 Vaufrey

Este yacimiento, conocido como Grotte Vaufrey o Grotte XV, se localiza en la Comuna de Cénac-et-Saint-Julien (Dordogna), a 8 kilómetros al sur de Sarlat. Forma parte del conjunto de cuevas del Macizo del Conte (Rigaud, 1988a), constituyendo una de las 22 cuevas



Figura 4.4 Localización del yacimiento de Grotte Vaufrey.

y abrigos presentes en los escarpados acantilados de la margen este del río Célou, justo antes de su confluencia con el río Dordoña (Grayson y Delpech, 1994; Turq, 2000). La apertura de la cavidad cuenta con una visera de 1 a 5 metros de altura y tiene una profundidad de 22 metros.

El primer sondeo fue realizado en 1930 por R. Vaufrey, que le dió su nombre a la cueva.

Sin embargo, las excavaciones fueron llevadas a cabo por J-Ph. Rigaud entre 1969 y 1982 (Rigaud, 1988a), en las que se definieron 15 capas (Turq, 2000). Durante estas excavaciones, recuperó numeroso material arqueológico y excavaron amplias superficies. En los niveles superiores (del I al VII), en parte destruidos por las excavaciones antiguas, la excavación contaba con una extensión de 15 m<sup>2</sup>, y los niveles más profundos, 10m<sup>2</sup>. La capa VIII fue excavada en una extensión de 78m<sup>2</sup> (Rigaud, 1988a; Turq, 2000). Las capas de la I a la XII

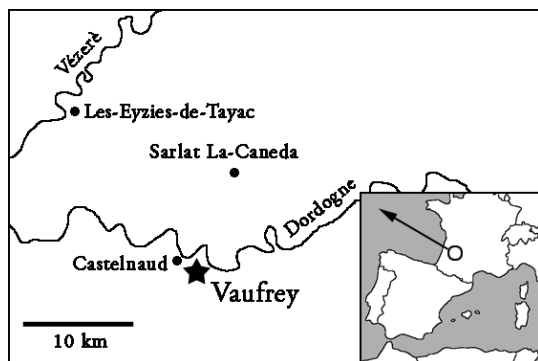

Figura 4.5 Esquema en planta de Vaufrey (Tomado de Hernandez et al., 2014).

consisten en una secuencia de ocupaciones achelenses y musterienses y las capas más profundas, de la XIII a la XV, contienen restos de fauna pero no artefactos (Grayson y Delpech, 1994). Las capas XIV y XV fueron datadas y asignadas al MIS 13 (Mindel-Riss), la capa XIII, XII y IX como final del Achelense y del nivel VIII al IV como Musteriense del Riss, MIS del 12 al 6 (Rigaud, 1988a; Turq, 2000). Probablemente los niveles del IV al VII (este último es el que se estudia en este apartado) son asignables al MIS 6 (Turq, 2000).

El estudio de la secuencia estratigráfica se realizó gracias a los diferentes cortes verticales realizados durante las excavaciones, que permitieron una descripción de los niveles arqueológicos en cuanto a su granulometría (Kervazo y Laville, 1988). Las aristas de los perfiles que constituyen estos cortes han sido nombradas como A, B, C, D, E y F, de tal manera un perfil queda delimitado por dos aristas, y de esta manera, se han nombrado como A-B, B-C, C-D, D-E y E-F (figura 4.5).

Los materiales arqueológicos que se han estudiado de este yacimiento provienen del nivel VII. En este caso, se eligió este nivel por presentar un excelente grado de conservación y una antigüedad sensiblemente mayor (aproximadamente 200.000 años) que la de los materiales de los niveles I y J de Le Moustier. Debido a su antigüedad y al periodo cultural al que pertenecen (Musteriense), también podríamos atribuir su autoría a la especie *Homo neanderthalensis*.

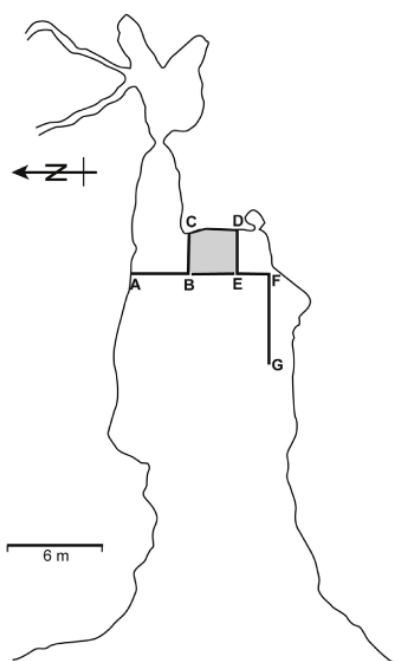
*lensis*. Por lo tanto, estos niveles cumplen las condiciones necesarias para estudiar los niveles poblacionales de la lateralidad en esta especie.

### Nivel VII

Este nivel fue excavado en una extensión de 19 m<sup>2</sup> (Rigaud, 1988b) y se caracteriza, según Kervazo y Laville, por la escasez de sedimento intersticial. Está compuesto, fundamentalmente, por plaquetas de calcita dispuestas de manera aleatoria, cuya disposición sugiere la intervención de procesos periglaciares (Kervazo y Laville, 1988). Localmente se han detectado en la base de la capa, en la porción sur del corte C-D, pequeños bloques de calcita

(Kervazo y Laville, 1988).

En la porción norte del corte C-D, el nivel VII se asienta sobre la unidad inferior VII-VIII, con un espesor de 10 centímetros, y hacia el sur aumenta su espesor progresivamente hasta los 80 centímetros, donde entra en contacto directamente con el nivel VIII (Kervazo y Laville, 1988).

Los perfiles C-D y D-E presentan una discordancia erosiva entre el nivel VII y los niveles subyacentes. La zona sur del corte C-D, presenta un enriquecimiento en sedimentos finos y cierta carbonatación. En el extremo oeste del perfil F-G, podemos apreciar la presencia local de plaquetas calcáreas sin sedimento intersticial. En el corte B-C, podemos apreciar tanto concentración de plaquetas como presencia de sedimento intersticial



Figura 4.6 Secuencia estratigráfica del yacimiento de Grotte Vaufrey (tomado de Hernandez et al., 2014).

(Kervazo y Laville, 1988). También podemos observar, según Kervazo y Laville, concreciones que afectan localmente al nivel VII, que podemos apreciar particularmente bien en el corte C-D (Kervazo y Laville, 1988).

En 2009, Texier realizó una revisión de la cronología y de los niveles de la Grotte Vaufray. Según él, existen 5 unidades litoestratigráficas: la unidad 1 (15-40 centímetros de espesor) que corresponde al nivel arqueológico I, compuesta principalmente por fragmentos de espeleotemas; la unidad 2 (110 centímetro de espesor) que corresponde con los niveles arqueológicos II, III y IV, compuesta por una diamictita oscura que incluye localmente algún depósito de colada y un nivel de arenas rojizas amarillentas con clastos; la unidad 3 (100-165 centímetros de espesor), que corresponde a los niveles arqueológicos V, VI, VII y VIII, compuesta en su parte superior por una diamictita amarilla con estructura lamelar fina, pasando lateralmente a unas facies más groseras, mientras que en su parte baja (nivel VIII) está compuesta mayormente por arenas laminadas; la unidad 4 (100-150 centímetros de espesor), que compone los niveles arqueológicos IX, X, XI, en la que se diferencian dos litofacies, una diamictita amarilla y otra de sedimento con clastos; y finalmente la unidad 5 (250 centímetros), que corresponde con los niveles arqueológicos XII, XIII, XIV y XV, compuesta por un criosuelo microscópico en la parte superior (nivel XII) y arenas de cuarzo en su parte inferior, en cuya base se pueden observar laminaciones cruzadas (Hernandez et al., 2014; Texier, 2009)

En lo relativo a la macro fauna, en el nivel VII aparece un molar inferior fragmentario de zorro. Aparece también un molar superior de un gran bóvido, posiblemente perteneciente a bisonte, siete molares de équidos, atribuibles al caballo de Mosbach (Delpech, 1988). En cuanto a micro fauna aparece lemming de las tundras, castor, marmota y un roedor del género *Spermophilus* (Marquet, 1988). Aparecen también restos de ictiofauna en este nivel, concretamente de salmón, trucha, cacho, dardo, esturión, perca y anguila (LeGall, 1988).

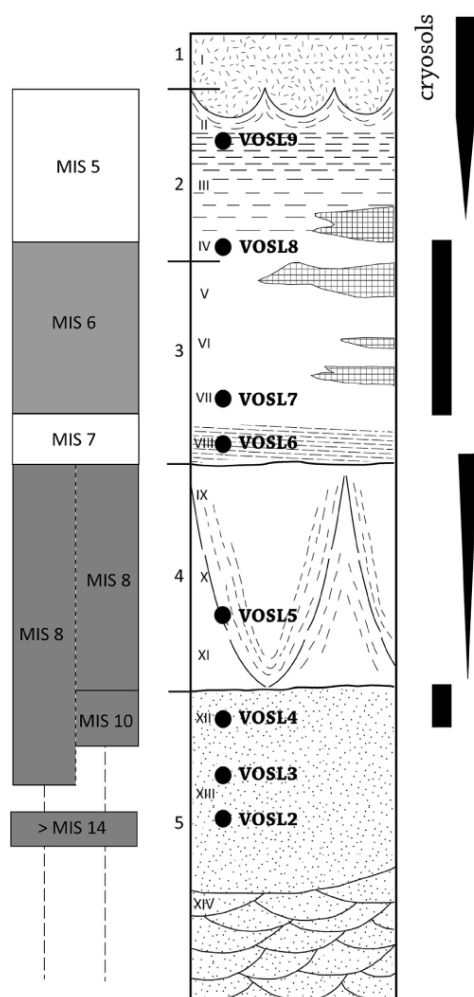
En cuanto al análisis tipológico de la industria lítica, según Rigaud (1988), el tramo de niveles del VIII al IV contiene útiles de tipo Levallois, raspadores con muescas, denticulados

y lascas de dorso rebajado, y lo adscribe a un Musteriense típico (Rigaud, 1988b). Concretamente, describe la industria lítica del nivel VII como un Musteriense típico con talla de tipo Levallois, con numerosas raederas, puntas bien representadas de elaboración cuidada, escasos cuchillos de dorso abatido, muescas y denticulados (Rigaud, 1988b).

En 2014, Hernandez et al. realizaron una revisión de las dataciones de los niveles arqueológicos, basándose en la datación de cuarzo sedimentario por TT-OSL. Tomaron ocho muestras en diferentes niveles arqueológicos, incluido el nivel VII que se estudia en este apartado. La muestra tomada en este nivel, denominada VOSSL7, dio como resultado una edad de  $205 \pm 20$  k. a., ubicando el nivel VII, según los autores, en el final del estadio isotópico MIS 7 (Hernandez et al., 2014).

Para el estudio de las fracturas parabólicas, de este nivel hemos estudiado un total de 254 restos, de los cuales 65 (25,6% del total) fueron rechazados por carecer de talón, elemento donde se desarrollan este tipo de fracturas. El 74,4% restante, 189, fueron considerados susceptibles de presentar fracturas parabólicas. Entre los restos que presentaban talón, el 85,2% de estos restos no presentaban este tipo de fracturas. El 14,8% restante, 28 elementos, sí presentaban estas fracturas y fueron analizados, medida la dirección de las parabolic crack y clasificados según los tipos L y R definidos en el capítulo de metodología. Los detalles se muestran en la siguiente tabla 4.5.

<b>Total:</b>	254
<b>Lascas sin talón:</b>	65 (25,6% del total)
<b>Lascas con talón:</b>	189 (74,4% del total)
<b>Lascas sin FP:</b>	161 (85,2% de los elementos con talón)
<b>Lascas con FP:</b>	28 (14,8% de los elementos con talón)

Tabla. 4.5 Detalle de los materiales estudiados en el nivel VII de Vaufrey.

#### 4.2.2.3 Axlor

El abrigo de Axlor, también conocido como Axlegorpe o Arlegor, está situado en el término municipal de Dima (Bizkaia), concretamente en el barrio Indusi. Se encuentra a 320 metros sobre el nivel del mar con una orientación Norte-Noroeste (Baldeón, 1999). Esta peña está constituida por calizas urgonianas de edad Albiense superior-Aptiense inferior. El abrigo de Axlor es una de las tres oquedades que se abren en el mismo flanco de la montaña y constituye una cavidad poco profunda, cerca de la cueva de Baltzola. La situación estratégica del yacimiento junto al barranco y al arco natural Jentilzubi lo convierten en un lugar de caza excelente y de cómoda habitabilidad debido a la proximidad de puntos de aprovisionamiento de agua y materia prima para la fabricación de herramientas (Baldeón, 1999).

El yacimiento fue descubierto por J. M. de Barandiarán en 1932, encontrando algunos restos arqueológicos que publicó ese mismo año. Pero no es hasta 1967 cuando se inicia la excavación sistemática de la cavidad. En primer lugar abrió una trinchera longitudinal a lo largo de la denominada por Barandiarán como banda 11 poniendo de manifiesto que

la cavidad había sido en parte vaciada debido a la actividad pastoril en la zona (Baldeón, 1999; Barandiarán, 1980). De esta manera los niveles I y II solo están presentes en una zona de la cavidad, preservados por la caída de una losa caliza del techo, y el nivel III es el primero en extenderse de manera más general e intacto desde el punto de vista arqueológico (Baldeón, 1999). Las excavaciones de Barandiarán terminaron en el año 1974. En 1980 Barandiarán publica los resultados de la



Figura 4.7 Localización del yacimiento de Axlor.

excavación en sus obras completas (Barandiarán, 1980) con la importante aportación de Altuna y Basabe (Altuna, 1989, 1972; Basabe, 1984, 1973). Los materiales arqueológicos son estudiados en detalle posteriormente por Amalia Baldeón en su tesis y publicados en 1999 (Baldeón, 1999).

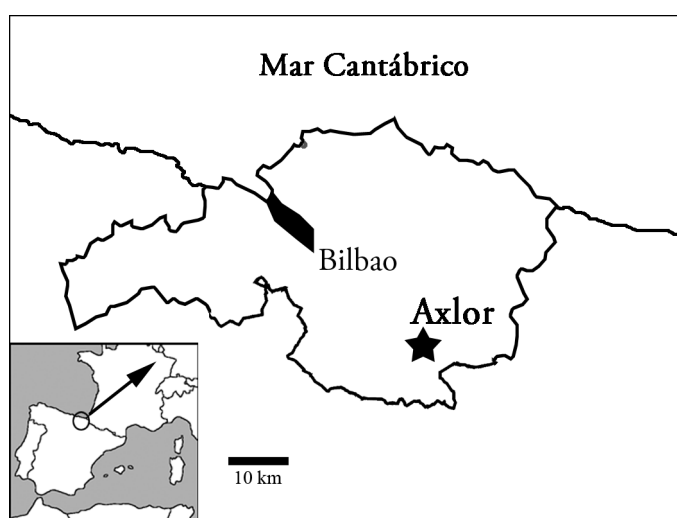

Figura 4.8 Secuencia estratigráfica del yacimiento de Axlor.

La secuencia estratigráfica de Axlor (figura 4.8), obtenida por Barandiarán después de excavar la banda 11, que ilustra en sus Obras Completas de 1980, es una columna del Paleolítico Medio carente de hiatos, con numerosos restos arqueológicos, tanto en las capas excavadas en extensión (20 m<sup>2</sup>) como en la trinchera de la banda 11 (6 m<sup>2</sup>). Se recuperaron también numerosos restos de fauna, que aparecen en forma de brechas, y algún resto humano.

A partir del año 2000 el yacimiento vuelve a ser excavado por J. E. González Urquijo, J. Ríos Garaizar y J. E. Ibáñez Estévez (Ríos et al, 2003). En este apartado hemos estudiado los materiales de las excavaciones antiguas de Barandiarán debido a su disponibilidad.

#### Nivel 0

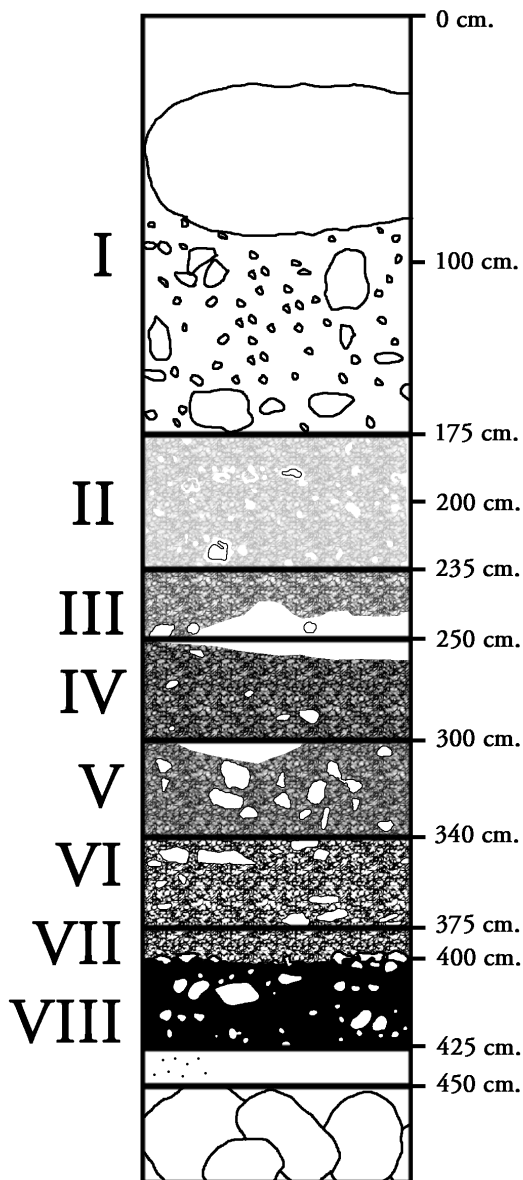
Este estrato cuenta con un metro de espesor y es el más superficial. Según Baldeón, debió ocupar en origen toda la superficie del yacimiento (Baldeón, 1999). Estaba formado por una terraza de cantos calizos cementados que fue barrida en algún momento, situada 50 centímetros por encima



del nivel 0 y hasta los -50 centímetros (Baldeón, 1999). Debido a la naturaleza de este nivel, no se ha incluido en el presente estudio.

#### Nivel I

Este nivel consiste en un guijarral con escasa tierra, de 2,25 centímetros de espesor y se extiende en profundidad hasta los -175 centímetros bajo el nivel 0 de superficie. En este nivel abundan los grandes bloques calizos y piedras angulosas, caídos al parecer durante el ciclo wurmiense debido a los fenómenos crioclásticos. Parte de este nivel, como se ha comentado anteriormente, se encontró parcialmente levantado en el momento de iniciar la intervención arqueológica (Baldeón, 1999). Este nivel no se ha estudiado en este trabajo debido a que solo cuenta con catorce restos arqueológicos. Para aplicar la metodología descrita, se requieren muestras que cuenten con un número de restos que pueda ser estadísticamente significativo.

#### Nivel II

Este nivel se diferencia perfectamente del anterior ya que cuenta con una matriz arenosa y pocas piedras. Su espesor es de 60 centímetros (esta comprendido entre las profundidades -175 y -235 centímetros por debajo del nivel 0 de superficie) y cuenta también con escaso material arqueológico (12 restos líticos) (Baldeón, 1999). Por esta razón, y porque además de una zona de crioclastia, que ha podido alterar este nivel y el anterior, no se ha incluido tampoco estos restos en el estudio de las fracturas parabólicas.

#### Nivel III

Este nivel fue excavado durante las campañas de 1967, 1968 y 1971 y es el primer nivel intacto y fértil, con una extensión horizontal excavada superior a los 20 m<sup>2</sup>. Su espesor es de 25 centímetros, llegando hasta una profundidad de -255 centímetros por debajo del nivel



superficial. Se trata de un depósito arenoso/arcilloso rojizo con numerosos cantos y gravas. Presenta una extraordinaria abundancia de restos óseos y de industria lítica (Baldeón, 1999). Además, en este nivel se recuperaron 3 molares, un premolar y un canino humano, que aparecieron junto a dos raederas y una punta de flecha (Baldeón, 1999; Barandiarán, 1980). Este nivel, *a priori*, cuenta con suficientes restos arqueológicos como para aplicar el método propuesto en esta tesis.

Para el estudio de las parabolic crack, de este nivel hemos estudiado un total de 899 restos, de los cuales 359 (39,9% del total) fueron desechados por carecer de talón, elemento sobre el que se desarrollan este tipo de fracturas. El 60,1% restante, 540, fueron considerados susceptibles de presentar fracturas parabólicas. Entre los restos que presentaban talón, el 92,2% de estos restos no presentaban este tipo de fracturas. El 8,1% restante, 44 elementos, sí presentaban estas fracturas y fueron analizados, medida la dirección de las parabolic crack y clasificados según los tipos L y R definidos en el capítulo de metodología. Los detalles se muestran en la siguiente tabla 4.6.

<b>Total:</b>	899
<b>Lascas sin talón:</b>	359 (39,9% del total)
<b>Lascas con talón:</b>	540 (60,1% del total)
<b>Lascas sin FP:</b>	496 (92,2% de los elementos con talón)
<b>Lascas con FP:</b>	44 (8,1% de los elementos con talón)

Tabla 4.6 Detalle de los materiales estudiados en el nivel III de Axló.

#### Nivel IV

Este nivel, que fue excavado en una extensión de aproximadamente 20 m<sup>2</sup> durante las campañas de los años 1968, 1969, 1971, 1972, 1973 y 1974, consiste en un depósito arcillo-arenoso que está más endurecido en su base, que en el techo. Presenta un grosor de

aproximadamente 50 centímetros y está comprendido entre las profundidades -255 y -300 centímetros bajo el nivel 0 superficial. Se trata del nivel más rico de todo el yacimiento, tanto en lo referente a los restos de fauna como a la industria lítica (Baldeón, 1999). Por ello, se ha considerado este nivel adecuado para aplicar el método descrito en esta tesis.

Para el estudio de las fracturas parabólicas, de este nivel hemos revisado un total de 3989 restos, de los cuales 1614 (40,5% del total) fueron rechazados por carecer de talón, elemento donde se desarrollan este tipo de fracturas. El 59,5% restante, 2375, fueron considerados susceptibles de presentar fracturas parabólicas. Entre los restos que presentaban talón, el 94,7% de estos restos no presentaban este tipo de fracturas. El 5,3% restante, 127 elementos, sí presentaban estas fracturas y fueron analizados, medida la dirección de las parabolic crack y clasificados según los tipos L y R definidos en el capítulo de metodología. Los detalles se muestran en la siguiente tabla 4.7.

<b>Total:</b>	3989
<b>Lascas sin talón:</b>	1614 (40,5% del total)
<b>Lascas con talón:</b>	2375 (59,5% del total)
<b>Lascas sin FP:</b>	2248 (94,7% de los elementos con talón)
<b>Lascas con FP:</b>	127 (5,3% de los elementos con talón)

Tabla 4.7 Detalle de los materiales estudiados en el nivel IV de Axló.

## Nivel V

Este nivel fue excavado durante las campañas de 1968, 1969 y 1974. Se trata de un depósito de naturaleza arenosa, suelta, con numerosos cantos calizos angulosos y algunas bolsadas de arcilla más compactada. Su espesor es de 40 centímetros y se extiende en la vertical hasta la cota -340 centímetros por debajo del nivel 0 superficial (Baldeón, 1999). Este nivel cuenta con numerosos restos arqueológicos por lo que, *a priori*, sus materiales son susceptibles de ser analizados bajo la perspectiva de la lateralidad y por ello se ha incluido en este estudio.

Para el estudio de las fracturas parabólicas, de este nivel se han estudiado un total de 884 restos, de los cuales 354 (40% del total) fueron rechazados por carecer de talón, elemento donde se desarrollan este tipo de fracturas. El 60% restante, 530, fueron considerados susceptibles de presentar fracturas parabólicas. Entre los restos que presentaban talón, el 94% de estos restos no presentaban este tipo de fracturas. El 6% restante, 32 elementos, sí presentaban estas fracturas y fueron analizados, medida la dirección de las parabolic crack y clasificados según los tipos L y R definidos en el capítulo de metodología. Los detalles se muestran en la siguiente tabla 4.8.

<b>Total:</b>	884
<b>Lascas sin talón:</b>	354 (40% del total)
<b>Lascas con talón:</b>	530 (60% del total)
<b>Lascas sin FP:</b>	498 (94% de los elementos con talón)
<b>Lascas con FP:</b>	32 (6% de los elementos con talón)

Tabla 4.8 Detalle de los materiales estudiados en el nivel V de Axlór.

#### Nivel VI

Este nivel fue excavado durante las campañas de 1968 y 1969 y consiste en un depósito de tierra pedregosa y compacta, de color ceniza en algunas zonas y más oscura en otras, con hogares en el lado oriental y más floja y arenosa en otras zonas, según Barandiarán (Baldeón, 1999; Barandiarán, 1980). El espesor de este nivel es de unos 40 centímetros, por lo que se extiende verticalmente hasta la cota -380 centímetros por debajo del nivel superficial (Baldeón, 1999). Este nivel también cuenta con numerosos restos, a pesar de que en este caso solo se excavaron 6 m<sup>2</sup> (solo la banda 11), por lo que también se ha incluido en el estudio de las fracturas parabólicas.

Para el estudio de las fracturas parabólicas, de este nivel hemos estudiado un total de 441 restos, de los cuales 165 (37,5% del total) fueron rechazados por carecer de talón, elemento

donde se desarrollan este tipo de fracturas. El 62,5% restante, 276, fueron considerados susceptibles de presentar fracturas parabólicas. Entre los restos que presentaban talón, el 89,5% de estos restos no presentaban este tipo de fracturas. El 10,5% restante, 29 elementos, sí presentaban estas fracturas y fueron analizados, medida la dirección de las parabolic crack y clasificados según los tipos L y R definidos en el capítulo de metodología. Los detalles se muestran en la siguiente tabla 4.9.

<b>Total:</b>	441
<b>Lascas sin talón:</b>	165 (37,5% del total)
<b>Lascas con talón:</b>	276 (62,5% del total)
<b>Lascas sin FP:</b>	247 (89,5% de los elementos con talón)
<b>Lascas con FP:</b>	29 (10,5% de los elementos con talón)

Tabla 4.9 Detalle de los materiales estudiados en el nivel VI de Axlor.

## Nivel VII

Este nivel consiste en una capa muy fina, de apenas 10 centímetros de espesor, que se extiende en profundidad hasta los -390 centímetros bajo el nivel superficial. Este nivel, como el anterior, también fue excavado solo en 6 m<sup>2</sup>, la banda 11, durante la campaña de 1969. Barandiarán describe el depósito como de tierra “negra de hogar en el lado E. y clara y pedregosa en el lado W. En la base tierra clara arenosa con grandes pedruscos” (Barandiarán, 1980). Nuevamente, a pesar del escaso espesor y que solo se excavaron 6 m<sup>2</sup>, este nivel aporta un gran número de restos arqueológicos, por lo que también se han incluido estos materiales en el estudio de la lateralidad a partir de las parabolic crack.

Para el estudio de las fracturas parabólicas, de este nivel se han estudiado un total de 128 restos, de los cuales 32 (25% del total) fueron rechazados por carecer de talón, elemento donde se desarrollan este tipo de fracturas. El 75% restante, 96, fueron considerados susceptibles de presentar fracturas parabólicas. Entre los restos que presentaban talón, el 86,5%

de estos restos no presentaban este tipo de fracturas. El 13,5% restante, 13 elementos, sí presentaban estas fracturas y fueron analizados, medida la dirección de las parabolic crack y clasificados según los tipos L y R definidos en el capítulo de metodología. Los detalles se muestran en la siguiente tabla 4.10.

<b>Total:</b>	128
<b>Lascas sin talón:</b>	32 (25% del total)
<b>Lascas con talón:</b>	96 (75% del total)
<b>Lascas sin FP:</b>	83 (86,5% de los elementos con talón)
<b>Lascas con FP:</b>	13 (13,5% de los elementos con talón)

Tabla 4.10 Detalle de los materiales estudiados en el nivel VII de Axló.

### Nivel VIII

Este es el nivel de base del yacimiento. Consiste en una capa de 50 centímetros de espesor, que abarca verticalmente hasta una profundidad de -440 centímetros. Nuevamente solo se excavó la banda 11, 6 m<sup>2</sup>. El depósito consiste en un sedimento de color negro que en la base es arenoso y con muchas piedras calizas que aumentan de tamaño a medida que se profundiza, llegando a ser grandes bloques en la base. También se documenta la presencia de hogares. A partir de la cota -420 centímetros, en los cuadros 11D, 11E, 11F y 11G dejan de aparecer materiales arqueológicos y se abandona la excavación debido a la escasez de evidencias humanas (Baldeón, 1999). Se desconoce si se llegó a la roca madre, ni que profundidad se alcanzó.

Para el estudio de las fracturas parabólicas, de este nivel se han estudiado un total de 85 restos, de los cuales 15 (17,6% del total) fueron rechazados por carecer de talón, elemento donde se desarrollan este tipo de fracturas. El 82,4% restante, 70, fueron considerados susceptibles de presentar fracturas parabólicas. Entre los restos que presentaban talón, el

92,9% de estos restos no presentaban este tipo de fracturas. El 7,1% restante, 5 elementos, sí presentaban estas fracturas y fueron analizados, medida la dirección de las parabolic crack y clasificados según los tipos L y R definidos en el capítulo de metodología. Los detalles se muestran en la siguiente tabla 4.11.

<b>Total:</b>	85
<b>Lascas sin talón:</b>	15 (17,6% del total)
<b>Lascas con talón:</b>	70 (82,4% del total)
<b>Lascas sin FP:</b>	65 (92,9% de los elementos con talón)
<b>Lascas con FP:</b>	5 (7,1% de los elementos con talón)

Tabla 4.11 Detalle de los materiales estudiados en el nivel VIII de Axlor.

### **4.3 Resultados del estudio de la lateralidad en materiales arqueológicos**

En este apartado presentados los resultados del estudio de la lateralidad en materiales arqueológicos del Neolítico y Calcolítico de Bizkaia, Álaba y Navarra (sociedades productoras) y del Paleolítico de Le Moustier, Vaufrey y Axlor (sociedades cazadoras-recolectoras).

#### **4.3.1 Sociedades productoras**

En el caso de las sociedades productoras se estudiaron un total de 100 hachas pulimentadas, de las cuales 59 (59%) presentan un corte rectilíneo sin desviar. Las 41 (41%) restantes presentan un corte desviado: 30 (73,2%) de ellas, desviado en sentido dextrógiro y 11 (26,8%), en sentido levógiro. Los detalles se muestran en la siguiente tabla 4.12.

<b>Sigla</b>	<b>Yacimiento</b>	<b>Tipo de corte</b>
90/4562	Ajangiz	D
BZ-8346	Baltzola	D
81/2914-2	Baltzola	D
81/2914-1	Baltzola	L
BER 099.3.6	Beraza	D
3062	Berreaga	D
BER-superficial-36	Berreaga	L
1360 Fdz. Medrano	Campo de los Palacios	D
DSB-2004	Dehesa de San Bartolomé	D
DSB-2016	Dehesa de San Bartolomé	D
DSB-2010	Dehesa de San Bartolomé	R
DSB-2011	Dehesa de San Bartolomé	D
DSB-2031	Dehesa de San Bartolomé	D
DSB-2014	Dehesa de San Bartolomé	D
DSB-2003	Dehesa de San Bartolomé	D
DSB 099.1.3	Dehesa de San Bartolomé	D
DSB 2003	Dehesa de San Bartolomé	D
2016 DSB (corte 1)	Dehesa de San Bartolomé	R
2010 DSB	Dehesa de San Bartolomé	R
2014 DSB	Dehesa de San Bartolomé	D
2011 DSB	Dehesa de San Bartolomé	D
2016 DSB (corte 2)	Dehesa de San Bartolomé	R
1420	Dima	D
El Espinal	El Espinal	D
Nº 105 CAA	El Huerto	D
94.2.6	El Llano	D
EU-14-1984	Embalse de Urrunaga	R
EU-23-144	Embalse de Urrunaga	D
EU-31-160	Embalse de Urrunaga	R
EU-21-60	Embalse de Urrunaga	R
EU-32-34	Embalse de Urrunaga	R
EU-32-33	Embalse de Urrunaga	D
EU-29-14	Embalse de Urrunaga	R
EU-4-41	Embalse de Urrunaga	R
EU-23-44	Embalse de Urrunaga	D
EU-24-76	Embalse de Urrunaga	D
EU-24-45	Embalse de Urrunaga	R

EU-24-46	Embalse de Urrunaga	R
EU-11-147	Embalse de Urrunaga	R
EU-A2-152	Embalse de Urrunaga	R
EU-5-150	Embalse de Urrunaga	L
EU-A1-39	Embalse de Urrunaga	D
EU-39-70	Embalse de Urrunaga	D
EU-39-72	Embalse de Urrunaga	L
EU-39-71	Embalse de Urrunaga	D
EU-39-151	Embalse de Urrunaga	D
EU-A1-146	Embalse de Urrunaga	L
EU-3	Embalse de Urrunaga	L
EU-14	Embalse de Urrunaga	R
EU-32	Embalse de Urrunaga	R
1-13.02.08/03	Ereñuko Arizti II	L
C.A.A. FM	Finca Maroto	R
1-20.02.03707	Galupa I	L
1077 Fdz. Medrano	Gasteiz	R
HR2-22	Hirumugarrieta II	R
KB-9A.135.5	Kobeaga I	D
LLO 095.4.6	La Llosa	D
LC II 88-II-8	Lacilla II	D
LCII.88.I.1	Lacilla II	D
LCII.88.II.6	Lacilla II	R
LCII.88.II.3	Lacilla II	L
LCII.88.I.4	Lacilla II	R
LCII.88.II.9	Lacilla II	R
Nº 11 CAA	Ladera La Majada	D
099.3.6	Laguardia	D
81/2264	Larraskitu	R
LCS	Las Canteras	D
LCS	Las Canteras	D
Exposición BIBAT (Vitrina 5)	Los Cascajos	R
Exposición BIBAT (Vitrina 5)	Los Cascajos	D
nº 104 CAA (p.35) 098.4.1	Los huertos	D
1-18.01.05/27	Los Zorros	D
90/2241	Maieskune	D
Miz 324	Mizkiartes	L
1-20.01.05/29	Ollagorta	D



105.4.2 en deposito	Paso Maenillo	D
PRA-B4-520	Pico Ramos	R
PRA-B5-524	Pico Ramos	R
PRA-B7-743	Pico Ramos	D
PRA-B4-521	Pico Ramos	D
PRA-C4-160	Pico Ramos	D
PRA-B5.161	Pico Ramos	R
PRA-B6-522	Pico Ramos	L
PRA-C5-159	Pico Ramos	D
PRA-B5-523	Pico Ramos	D
PRA-B5-162	Pico Ramos	D
Nº104 CAA	Pipaón	D
Sala 097.3.1	Salas	D
SMAR caja nº 46	San Martin	D
SMAR Fondos de caja 46	San Martín	D
Zumelzu 9/11/87	Zumeltzu	D
1066 Fdz Medrano	Procedencia desconocida	R
1065 Fdz Medrano	Procedencia desconocida	D
1360 Fdz Medrano	Procedencia desconocida	D
1077 Fdz Medrano	Procedencia desconocida	R
095.1.4	Procedencia desconocida	D
XR 268.3.1	Procedencia desconocida	R
099.3.2	Procedencia desconocida	D
099.3.2	Procedencia desconocida	D
099.3.2 (267)	Procedencia desconocida	D

Tabla. 4.12 Detalle de los resultados obtenidos a partir de los útiles pulimentados estudiados en Bizkaia, Álava y Navarra.

Los materiales han sido fotografiados y dibujados en su cara frontal (cara C, según Fandos 1973) y medida su longitud máxima, anchura máxima, espesor máximo y anchura del corte. Estos datos, junto con la catalogación del corte según los tipos D, R y L descritos anteriormente, están recogidos en el Anexo I.



Figura 4.9 Fotografía y esquema del corte de dos de las hachas pulidas arqueológicas estudiadas, una del Embalse de Urrunaga (A) y otra de Mizkiartes (B).

La figura 4.9 muestra dos de las hachas pulidas estudiadas, una del Embalse de Urrunaga (A) y otra de Mizkiartes (B). Se ha detallado una fotografía la cara frontal (cara C, según Fandos 1973) y se ha representado un esquema del corte en el que se han dibujado los dos ejes de referencia (uno horizontal y otro vertical) de tal manera que se aprecia la desviación de cada corte. En el caso del ejemplo A, el corte presenta una amplitud 1 positiva y una amplitud 2 negativa, según la metodología descrita en el capítulo 3, por lo que el corte estaría desviado en sentido dextrógiro y se trataría de un corte tipo R. En el caso del ejemplo B ocurre lo contrario, presenta una amplitud 1 negativa y una amplitud 2 positiva, por lo que el corte estaría desviado en sentido levógiro y se trataría de un corte tipo L.

#### 4.3.2 Sociedades cazadoras-recolectoras

En el caso de las sociedades cazadoras-recolectoras de neandertales se estudiaron un total de nueve niveles: dos del yacimiento del abrigo de Le Moustier, uno del yacimiento Grotte Vaufrey y seis del yacimiento del abrigo de Axlor.

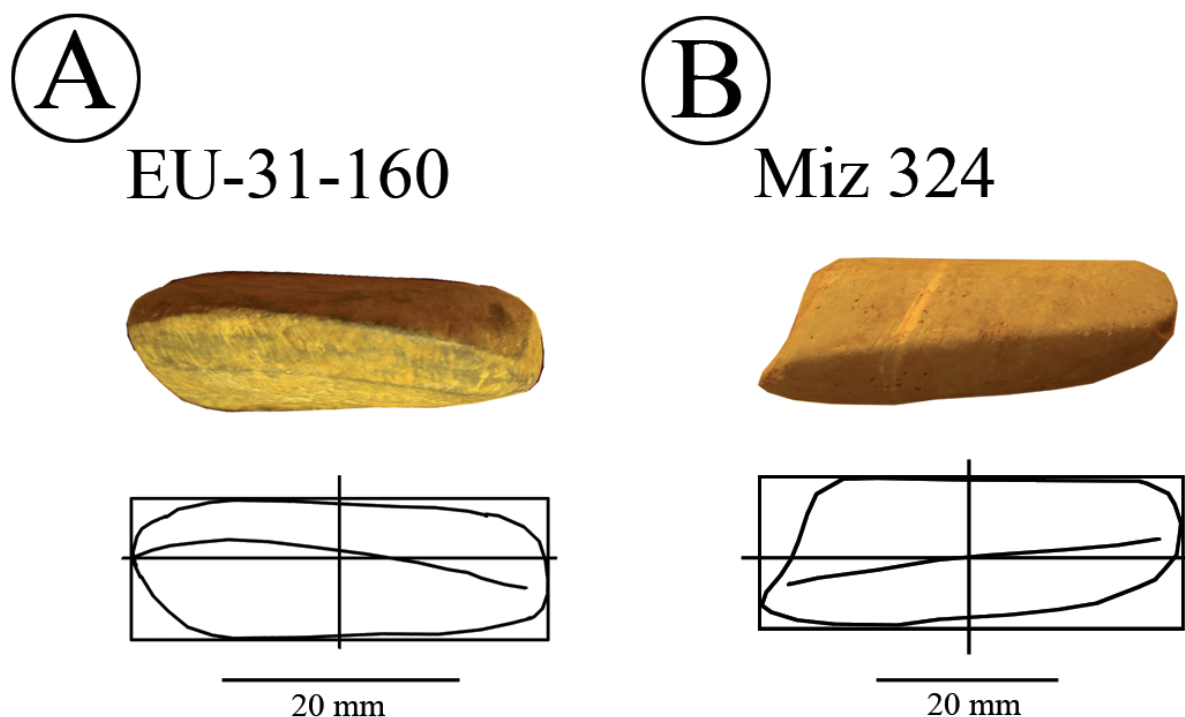
En el yacimiento de Le Moustier, del total de los elementos estudiados, 227 lascas del nivel I y 184 lascas del nivel J, presentaban fracturas parabólicas bien conservados como para ser estudiados desde una perspectiva de la lateralidad. Tal y como hemos mencionado en el capítulo 3, midiendo la dirección del eje de simetría de la parábola que forman en su conjunto las fracturas parabólicas podemos clasificar las lascas según dos categorías: L y R; extraídas del núcleo sosteniendo el percutor con la mano izquierda o derecha respectivamente.

Las 227 lascas del nivel I y las 184 lascas del nivel J han sido medidas, fotografiadas y clasificadas según la dirección del eje de simetría de sus fracturas parabólicas, todo ello detallado en el Anexo II. Las medidas que han sido tomadas son la longitud máxima (medida perpendicularmente al talón), la anchura máxima (medida perpendicularmente a la longitud máxima, en el plano perpendicular al talón) y el espesor máximo (medido perpendicularmente al plano que forman las otras dos medidas). La tabla 4.13 muestra el número de lascas que han sido clasificadas dentro de cada tipo para cada nivel. En el caso del nivel I, de un total de 227 lascas, 67 (29,5%) se han clasificado como L y 160 (70,5%) como R. En el caso del nivel J, de un total de 184 lascas, 64 (34,8%) se han clasificado como L y 120 (65,2%) como R.

	<b>Tipo de parabolic crack</b>		<b>Total</b>
	<b>L</b>	<b>R</b>	
<b>Nivel I</b>	67 (29,5%)	160 (70,5%)	227
<b>Nivel J</b>	64 (34,8%)	120 (65,2%)	184

Tabla 4.13 Detalle de los resultados obtenidos a partir de las lascas estudiadas en el yacimiento de Le Moustier.

En el yacimiento de Grotte Vaufrey, del total de los elementos estudiados, 189 lascas del nivel VII presentaban fracturas parabólicas bien conservadas como para ser estudiadas desde una perspectiva de la lateralidad. Como hemos mencionado en el capítulo 3, midiendo la dirección del eje de simetría de la parábola que forman en su conjunto las fracturas parabólicas podemos clasificar las lascas según dos categorías: L y R; extraídas del núcleo sosteniendo el percutor con la mano izquierda o derecha respectivamente.

Las 189 lascas del nivel VII han sido medidas, fotografiadas y clasificadas según la dirección del eje de simetría de sus fracturas parabólicas, todo ello detallado en el Anexo II. La tabla 4.14 muestra el número de lascas que han sido clasificadas dentro de cada tipo. De un total de 189 lascas, 8 (28,6%) se han clasificado como L y 20 (71,4%) como R.

	<b>Tipo de parabolic crack</b>		<b>Total</b>
	<b>L</b>	<b>R</b>	
<b>Nivel VII</b>	8 (28,6%)	20 (71,4%)	28

Tabla 4.14 Detalle de los resultados obtenidos a partir de las lascas estudiadas en el yacimiento de Vaufrey.

En el yacimiento de Axlor, del total de los elementos estudiados, 44 lascas del nivel III, 127 del nivel IV, 32 del nivel V, 28 del nivel VI, 13 del nivel VII y 5 del nivel VIII, presentaban fracturas parabólicas bien conservadas como para ser estudiadas desde una perspectiva de la lateralidad.

Todas las lascas que presentan este tipo de fracturas han sido medidas, fotografiadas y clasificadas según la dirección del eje de simetría de sus fracturas parabólicas, todo ello detallado en el Anexo II. La tabla 4.15 muestra el número de lascas que han sido clasificadas dentro de cada tipo.

	Tipo de parabolic crack		Total
	L	R	
<b>Nivel III</b>	10 (22,7%)	34 (77,3%)	44
<b>Nivel IV</b>	37 (29,1%)	90 (70,9%)	127
<b>Nivel V</b>	7 (21,9%)	25 (78,1%)	32
<b>Nivel VI</b>	10 (34,5%)	19 (65,5%)	29
<b>Nivel VII</b>	7 (53,8%)	6 (46,2%)	13
<b>Nivel VIII</b>	0 (0%)	5 (100%)	5

Tabla 4.15 Detalle de los resultados obtenidos a partir de las lascas estudiadas en el yacimiento de Axlor.

Yacimiento	Nivel	Nº muestra	Ratio L/R
<b>Le Moustier</b>	I	228	2,9/7,1
<b>Le Moustier</b>	J	184	3,5/6,5
<b>Axlor</b>	IV	127	2,9/7,1
<b>Axlor</b>	III	44	2,3/7,7
<b>Axlor</b>	V	32	2,2/7,8
<b>Axlor</b>	VI	29	3,4/6,6
<b>Vaufrey</b>	VII	28	2,9/7,1
<b>Axlor</b>	VII	13	5,4/4,6
<b>Axlor</b>	VIII	5	0/10

Tabla 4.16 Síntesis de todos los niveles estudiados y el ratio L/R para cada uno de ellos.

En la tabla 4.16 se observa que los ratios de zurdo/diestro oscilan principalmente entre 3,5/6,5, para el caso con mayor número de zurdos y menor número de diestros, y 2,2/7,8, para el caso con menor número de zurdos y mayor número de diestros, exceptuando los ratios 0/100 y 5,4/4,6 de los niveles VIII y VII respectivamente, que son los niveles en los que el tamaño de la muestra estudiada es menor.



Figura 4.10 Fotografía y esquema del talón de dos de las lascas arqueológicas estudiadas, una del nivel III de Axlør (A) y otra del nivel IV de Axlør (B). Se ha detallado la fotografía del talón, en la que se ha marcado un eje horizontal de referencia para orientar la lasca. También se ha ampliado la zona que presenta fracturas parabólicas, acompañándola de un esquema. Se ha marcado la dirección y sentido del eje de simetría, de las fracturas parabólicas, como se ha descrito en el capítulo 3, y señalado los grados sexagesimales que forman con el eje vertical, en positivo los contados en sentido dextrógiro (A), denotando una parabolic crack de tipo R, y en negativo contados en sentido levógiro, denotando una de tipo L.

La figura 4.10 muestra dos de las lascas estudiadas, ambas del yacimiento de Axlør, una del nivel III (A) y otra del nivel IV (B).

La tabla 4.17 muestra los niveles de lateralidad generales para sociedades productoras, a partir de una síntesis de todos los útiles pulimentados estudiados en las regiones de Bizkaia, Álava y Navarra, y los niveles de lateralidad generales para sociedades cazadoras-recolectoras, a partir de una síntesis de todos los niveles arqueológicos estudiados en los yacimientos de Le Moustier, Vaufray y Axlør. Para el caso de sociedades productoras un total de 40 hachas pulidas presentaban el corte desviado, 11 de ellas en sentido levógiro (27,5%), clasificadas

como L, y 29 en sentido dextrógiro (72,5%), clasificadas como R, lo que supondría un índice zurdo/diestro de 2,7/7,3 para las sociedades productoras estudiadas. Para el caso de las sociedades cazadoras-recolectoras un total de 690 lascas presentaban fracturas parabólicas, de las cuales 210 (30,4%) las presentaban con una orientación hacia la izquierda, clasificadas como L, y 480 (69,6%) con una orientación a la derecha, clasificadas como R. Esto supondría un índice zurdo/diestro de 3/7 para las sociedades cazadoras-recolectoras estudiadas.

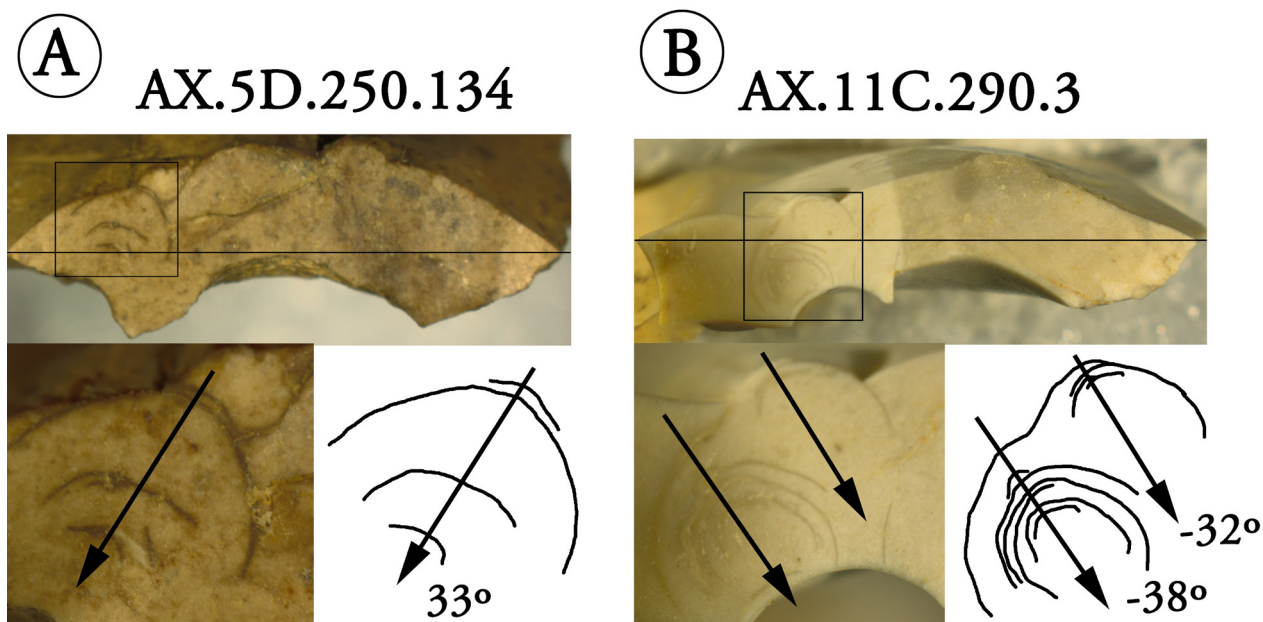
	<b>L</b>	<b>R</b>	<b>Total</b>	<b>Ratio L/R</b>
<b>Sociedades productoras</b>	11 (26,8%)	30 (73,2%)	41	2,7/7,3
<b>Sociedades cazadoras-recolectoras</b>	210 (30,4%)	480 (69,6%)	690	3/7

Tabla 4.17 Síntesis de los resultados para los dos tipos de sociedades estudiados.

Los siguientes gráficos muestran las proporciones de zurdos y diestros (L y R) para sociedades productoras (A) y cazadoras-recolectoras (B). Se observa que los niveles poblacionales de lateralidad para sociedades cazadoras-recolectoras son de un ratio zurdo/diestro de 3/7, mientras que en las sociedades productoras estarían ligeramente más lateralizadas con un ratio zurdo/diestro 2,7/7,3, con una proporción de diestros algo mayor.



Figura 4.11 Proporción general de zurdos y diestros para sociedades productoras (A) y cazadoras-recolectoras (B).



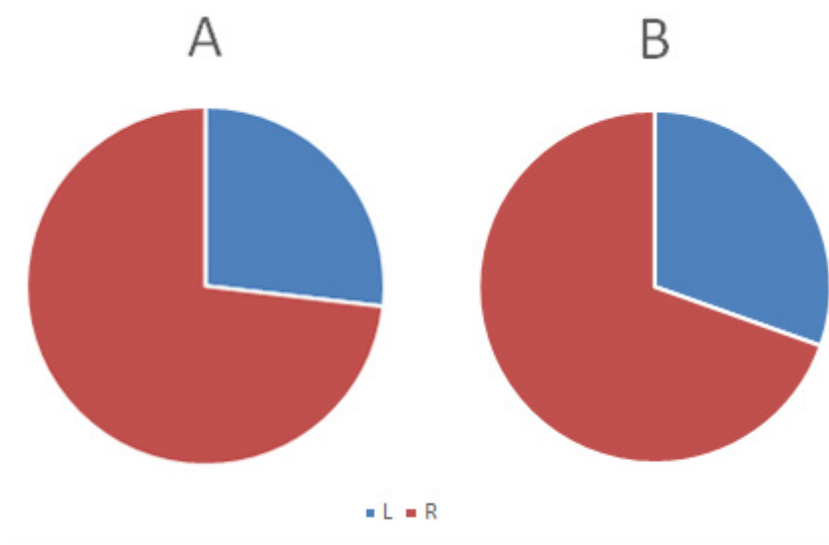

**Chapter 5:**

# **Discussion**



## **5.1 Introduction**

In Spanish, the term “lateralidad” is used to refer indistinctly to any type of asymmetry, both anatomical and behavioural. In this way, it covers brain function asymmetries, such as the function of language in one or other of the hemispheres, brain anatomical asymmetries, such as size differences between the two hemispheres, other anatomical asymmetries, such as the size differences between the left and right lung, and behavioural asymmetries like ocular dominance. However, in the Anglo-Saxon world, some specific terms are sometimes used to refer to each behavioural laterality, such as “handedness” to refer to manual laterality (or manual dominance), or “eyeness”, for ocular laterality or dominance. While laterality can also be used in the wider sense, as in Spanish, it is usually reserved for anatomical asymmetries.

In recent decades, some scientists have detected asymmetries throughout the whole subphylum of vertebrates and even in some invertebrate species (MacNeilage et al., 2009; Rogers et al., 2013). Table 5.1. shows, in general terms, the anatomical and behavioural asymmetries found in vertebrates.

	<b>Anatomical Asymmetries</b>	<b>Asymmetric Behaviors</b>	<b>Reference</b>
<b>Fishes</b>	Hemispheric Specialization (Zebrafish), Eyes (Flat Fish), Sexual Organs ( <i>Anableps anableps</i> )	Hit their preys on the right side	(Barth et al., 2005; Bisazza et al., 2007; Chen et al., 2001; Dadda and Bisazza, 2006; Friedman, 2008; Gardner, 2005; Halpern et al., 2003; MacNeilage et al., 2009)
<b>Crabs</b>	Pincer ( <i>Uca vocans vomeris</i> )		(Backwell et al., 2007)
<b>Insects</b>	Front paws (flies)		(Klingenberg et al., 1998)
<b>Amphibians</b>	Front paws (toads)	Hit their preys on the right side	(Klingenberg et al., 1998; MacNeilage et al., 2009)
<b>Birds</b>	Sexual organs	Independent control of each eye (chickens), lateralized memory (chickens), dominance of paw (parrots), asymmetric reaction to fear, attack and copulation (chickens)	(Andrew, 1988; Calhim and Birkhead, 2009; Horn and Johnson, 1989; Petrova and Markovskikh, 1986; Rogers, 1982; Zappia and Rogers, 1983)
<b>Non-primate mammals</b>	Hemispherical asymmetries (rats, dogs, cats, whales), canine (narwhal)	Paw dominance (rats, cats, dogs), opening of the eyes at birth, feeding asymmetries (whales), ability to sleep only one hemisphere (dolphins), swimming (dolphins), flying (bats)	(Aydinlioglu et al., 2000; Cole, 1955; Fabre-Thorpe et al., 1993; Guven et al., 2003; Kolb et al., 1982; Krutch, 1952; MacNeilage et al., 2009; Mukhamev, 1987; Narang, 1977; Pence, 2002; Stafne, 2004; Tan et al., 1990; Tan and Caliskan, 1987)
<b>Marsupials</b>		Paw dominance (common brushtail possum, koala)	(Megirian et al., 1977; Smith, 1979)
<b>Non-human primates</b>	Brain asymmetries (macaca)	Hand preference (great apes, capuchin monkeys, macaca, cebus monkeys), search for food (gálagos, great apes), climbing (marmosets)	(Box, 1977; Falk et al., 1988; Matsataka, 1990; Matoba et al., 1991; Rothe, 1973; Sanford et al., 1984; Stellar, 1960)

Table 5.1 Asymmetries found in the animal kingdom

However, it is human beings who show the most marked behavioural laterality. We are the only primates with a laterality clear seen in the upper limbs. It also appears to a lesser ex-

tent in the lower limbs and to an even smaller degree in eyes and ears (Annett, 2002, 1970; Porac and Coren, 1981). This preference to use one of the sides of the body predominantly increases when the task involves the use of a tool and is most marked in complex tasks (Healey et al., 1986; Hinckley et al., 1997; Marchant et al., 1995; Provins, 1997b; Steenhuis and Bryden, 1989). Therefore, when manual dominances are compared among primate species or other animal species, it should be borne in mind that not all the animals can use the same kinds of tools, or all the animals possess the same skill in using tools.

Individuals are denominated left-handed or right-handed according to the upper limb which is given the dominant role (Marchant et al., 1995) and left/right-handed ratios can be established for different populations. Handedness is hereditary (Annett, 1973; Armour et al., 2014; Brandler et al., 2013; Levy and Nagylaki, 1972; McManus, 1991; McManus et al., 2013). But it is also greatly influenced by environmental and cultural factors, such as socioeconomic status (Annett and Kilshaw, 1983; Faurie and Raymond, 2013; Leiber and Axelrod, 1981; Perelle and Ehrman, 1994), geographic-cultural origin (Bryden et al., 1993; Holder and Kateeba, 2004; Marchant et al., 1995; McManus, 2009; Porac and Coren, 1981; Raymond and Pontier, 2004) and the level of sociological Westernisation of the individual (Faurie et al., 2005; Marchant et al., 1995). Therefore, although there is a genetic factor, culture influences laterality and populations formed by individuals of the same species may display different population-level laterality.

Among modern primates, the most lateralised, with the greatest brain asymmetry, is *Homo sapiens*, with a ratio of 1:9 in Western societies (Cashmore et al., 2008; Hardyck et al., 1975; Hopkins, 2013; Marchant and McGrew, 2013; McManus, 2009; McManus et al., 2013; Perelle and Ehrman, 1994). Chimpanzee (*Pan troglodytes* and *Pan paniscus*) is the next most lateralised, but with a ratio of only 1:1.72 (Hopkins et al., 2011). This suggests that during the evolution of our ancestors, manual dominance become more powerful as more elaborate strategies to obtain food had to be developed (MacNeilage et al., 2009).

<b>Left-handed %</b>	<b>Country</b>	<b>Reference</b>
3,4	Burkina Faso (Bobo-Dioulasso)	Faurie et al. (2005)
5	Japón	Raymond and Pontier (2004)
7	Estados Unidos de America	Plato et al. (1984); Quinan (1930, 1922)
7,1	Estados Unidos de America	Raymond and Pontier (2004)
8,9	Reino Unido	Connolly y Bishop (1992)
10,2	Gabón (tribu Baka)	Faurie et al. (2005)
11,4	Algeria, Costa de Marfil, Sudán y Reino Unido	Raymond and Pontier (2004)
12,4	Reino Unido	Raymond and Pontier (2004)
15	Papua Nueva Guinea	Connolly and Bishop (1992)
15	Francia	Raymond and Pontier (2004)
15	Botswana (tribu G/wi San)	Marchant et al. (1995)
16	Venezuela (tribu Yanomamo)	Marchant et al. (1995)
19,6	Papua Nueva Guinea	Raymond and Pontier (2004)
21	Namibia (tribu Himba)	Marchant et al. (1995)
22	Costa de Marfil	Raymond and Pontier (2004)
26,9	Indonesia (tribu Eipo)	Faurie et al. (2005)

Table 5.2 Proportion of left-handed individuals in the different countries studied in the literature.

As Table 5.1 shows, asymmetries are not exclusive to our species and therefore their most basic structures must have a long evolutionary tradition. However, laterality is only clearly seen in our genus. Table 5.2 shows that all the studied populations contain far more right-handed individuals than left-handed ones, but great variability is seen in the proportions of left-handed individuals in each population.

### 5.1.1 Importance of the study of laterality

It is of interest to discover any information that the archaeological record might reveal about biology, culture or the context in which our ancestors lived. In this respect, knowing laterality levels of a prehistoric population is in itself very valuable information. Discovering

whether or not different right-handed and left-handed individuals existed in past societies can help to understand how an activity such as hunting may have been organised, or if left-handedness was attributed any particular value. But knowing population-level laterality can also provide information about other aspects. Brain functions are asymmetric within the brain (Bisazza et al., 1998) and laterality is one of the clearest etological manifestations of the presence of these asymmetries. High lateralisation levels in a population indicate that its members possess brain asymmetries. Laterality is also clearly related to language, albeit in a complex way (Knecht et al., 200a). Indeed, the brain functions of language were precisely some of the first brain asymmetries to be detected (Broca, 1861; Wernicke, 1874). The brain areas responsible for language are mostly found in the left hemisphere. However, for a small part of the population they are in the right hemisphere. This proportion of the population is not divided equally among left-handed and right-handed individuals: only 4% of right-handed people possess language in the right hemisphere, whereas for 27% of left-handed people it is in this right hemisphere (Knecht et al., 2000b).

Articulated language is a quality unique to our genus. Understanding when it appeared and how it evolved is a matter that has attracted great interest in the scientific community in recent decades (Balari et al., 2008). The language of our ancestors can be studied through two sources of evidence: the archaeological and the paleontological records (Martínez and Arsuaga, 2009). Numerous papers have studied language in fossil species through paleontology (Lieberman, 1984; Lieberman et al., 1992, 1972; Lieberman and Crelin, 1971; Martínez et al., 2009, 2008a, 2008b, 2004; Tobias, 1983). In contrast, in this thesis a method has been developed to determine handedness in the archaeological record. Since laterality and language are related, the study of archaeological remains can contribute data to the study of language in our ancestors.

### 5.1.2 Measuring handedness

There are different ways to measure handedness and therefore, in a study aiming to measure the degree of lateralisation of an individual or a population, we have to choose the way

of measuring handedness best adapted to our study. Similarly, if we are going to compare laterality levels obtained by studies that used different ways of measuring handedness, it must be done with caution. Two types of methods are used in studies of modern populations to determine a person's handedness: questionnaires (e.g. Bryden, 1977; Zverev, 2006) and observation of a particular task (e.g. Annett, 1994; Connolly and Bishop, 1992). In the first case, a series of questions are adapted to the socio-cultural situation of the individual. For example, people in a literate population are asked which hand they write with, whereas individuals in an illiterate population are asked which hand they use, for example, to cut with a machete. In the second case individuals are asked to carry out a certain task, also adapted to their socio-cultural situation, and the hand they use is noted. However, manual laterality varies depending on the task being observed or the question asked (Annett, 2009a). Therefore, when comparing laterality levels in two populations, if different ways of measuring it have been used, such as different questions in the questionnaires, or by observing different tasks, the comparison should be made with caution.

In studies of laterality in past societies, it is obviously impossible to ask questions or observe tasks being performed. Some studies deduce the laterality of fossil individuals through their bone or dental remains. However, these studies generally work with small samples and therefore the results are not quantifiable statistically. Another option is to attempt to study laterality through the evidence allowing a deduction of how a particular task was carried out. Cave art has been studied to determine whether the depictions were made with the right or left hand, but once again, the scarcity of such evidence and their circumscription to a chronology hinders the extraction of statistically quantifiable data. In consequence, archaeological artefacts, which were also produced by a certain task (knapping, polishing, etc.) or which were used for a certain task (cutting, scraping, etc.) may be used to obtain information about the producer or user, with the advantage that their abundance and widespread presence in time and space enables a sample to be studied that a priori is large enough to extract statistically quantifiable data.

Another important point when measuring the laterality of a population is to choose a



study sample that is representative of that population. In Section 3, we calculate the minimum size of a sample for it to be representative of the population being studied, based on previous data and estimates. In the case of studying handedness through the archaeological record, the sample size is determined by the number of archaeological remains that have been found with the right characteristics for the study. Table 5.3 shows the different levels and number of remains that have satisfied the necessary conditions to be studied.

Site	Level	Sample size
Le Moustier	I	228
Le Moustier	J	184
Axlor	IV	127
Axlor	III	44
Hachas pulidas		41
Axlor	V	32
Axlor	VI	29
Vaufrey	VII	28
Axlor	VII	13
Axlor	VIII	5

Table 5.3 Size of the sample analysed in each archaeological level in the study.

As explained in Section 3, the minimum representative sample for an infinite population is 28.85. As Figure 5.1 shows, the proportion of right-handed individuals deduced for each of the levels where over 21.85 remains have been studied varies from 65.2% to 78.1%, with a central value of 71.65%. Therefore, the only assemblages where fewer remains have been studied than would be representative are from Levels VII and VIII at Axlor, and for this reason the results obtained are anomalous. In the case of farming societies and hunter-gatherer societies in general, the sample size is larger than the minimum representative sample (Table 5.4).

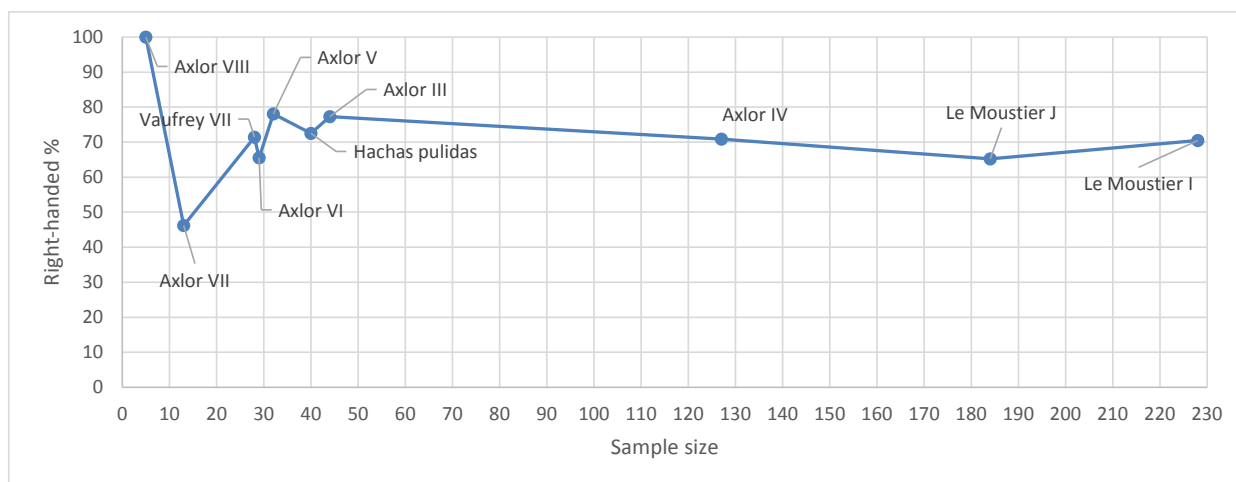

Figure 5.1 Proportion of right-handed individuals in the different assemblages and archaeological levels in the study.

	Sample	L	R	L/R
<b>Farmeing societies</b>	41	11	30	2,68/7,32
<b>Hunter-gatherer societies</b>	690	210	480	3,04/6,96

Table 5.4 Size of the sample, number of elements classified as L or R, and handedness ratio obtained.

### 5.1.3 Laterality in past societies

Modern populations display large variations in the ratio of left and right-handed individuals (Connolly and Bishop, 1992; Plato et al., 1984; Quinan, 1930, 1922; Raymond and Pontier, 2004). According to these studies, the factors that influence the ratio are predominantly socioeconomic and cultural. The level of industrialisation of a population, which ultimately determines the degree of use of tools by each individual, influences the lateralisation levels of the individual. In highly industrialised societies, individuals tend to use tools, some of which are very complex, such as computers, mobile phones and cars. Since, as remarked above, the complexity of the task affects the level of lateralisation of an individual, in these societies we find that people who carry out tasks that involve the use of this type of tools display very marked dominance. However, in less industrialised societies, in which the use of this type of tool is more unusual, individuals display a more flexible manual do-

minance.

In the present research, our first objective was to know the laterality levels in a population formed by individuals of our own species but with a different culture. In this way, the influence of the cultural factor in laterality levels in a society can be assessed. Consequently, literature on laterality studies in modern non-industrialised societies was analysed, as described in Chapter 2. Then a method, explained in Chapter 3, was developed to establish the population-level laterality in prehistoric farming societies by studying archaeological artefacts from Biscay, Álava and Navarre. Once the impact of these cultural factors had been understood, another method, also explained in Chapter 3, was developed to establish the population-level laterality in hunter-gatherer societies formed by *Homo neanderthalensis* and to understand how the phenomenon of laterality appeared and evolved in our own evolutionary line. To do this, artefacts from Le Moustier, Grotte Vaufrey and Axlor were studied. In this Chapter 5 we shall discuss the two methods described in Chapter 3 and the results presented in Chapter 4.

## 5.2 Laterality observed in polished stone axes

Studying Chalcolithic and Neolithic polished stone tools from Álava, Biscay and Navarre, we found that some cutting edges displayed a deviation. Through an experimental programme and the study of the chaîne opératoire to produce these tools, we deduced that the handedness of the producer would influence this deviation and therefore these tools could be used to analyse the laterality of the makers of polished stone axes in prehistory.

For this thesis, a method was developed, capable of studying the polished stone axes made by prehistoric populations from the laterality point of view and in this way establish the population-level laterality for those societies.

### 5.2.1 Discussion on the method

Based on the studies of the Langda, the grindstone is placed on the ground in front of the artisan who crouches with the stone between his legs (Toth et al., 1992). In the case of a right-handed individual, the stone to be ground is held in his right-hand, and using the whole right hand-arm-shoulder system, the tool is shaped by grinding it on the sandstone. Although the left arm and hand may be used, it is always as a secondary support and the right-hand does all the work of guiding the axe. In the case of a left-handed person, the process is similar but inverse.

The arm holding the tool moves in a circumference by pivoting around the shoulder. This circular movement involves a centrifugal force which means that the axe is abraded more on the one side (Figure 5.2). The spatial relationship between the centrifugal force and the axe is analogous whether the grinder is right-handed (A) or left-handed (B) but in the opposite direction. These grinding conditions create an equivalent deviation of the edge, but an op-

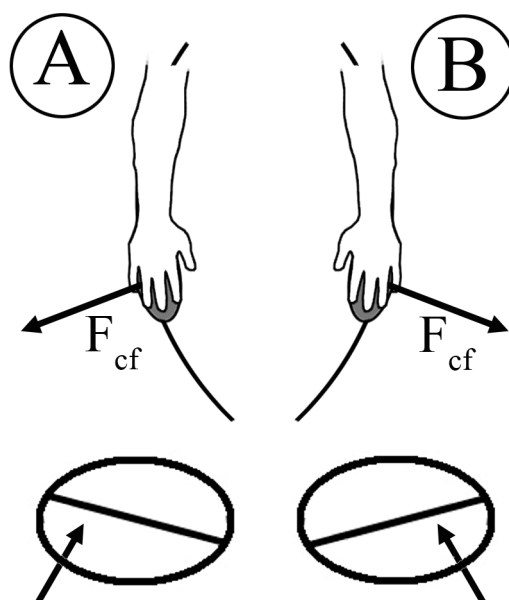

Figure 5.2 Schematic representation of the circular movement made by the arm of a right-handed person (A) and a left-handed person (B) and the centrifugal force ( $F_{cf}$ ) (Top). View of the edge profile showing the application of most abrasion (Bottom).

posing one, depending on whether the artisan is right-handed or left-handed. According to this process, the edges have been divided into three categories: non-deviated edge (D), edge deviated to the right (R) and edge deviated to the left (L).

Observation of the evolution in the edge shape, during the grinding process, shows that at all times, the axe is ground more intensely on its external side, which is the side on the outside of the circle made by the grinding arm.

According to the experimentation results, we can associate the edge shape with the laterality of the axe maker. The centrifugal force created when the stone is ground on the grindstone, due to the pivoting action of the arm around the shoulder, causes a differential wear on the abrasion surface of the axe. This differential wear is in opposite directions, depending on whether the axe maker is right-handed or left-handed, producing two edge shapes. These two shapes consist of two kinds of straight edges with an analogous deviation, in opposite directions depending on whether they are made by a right-handed or left-handed person. In 59% of the archaeological objects, this differential abrasion does not occur or its effect is imperceptible, producing a non-deviated straight edge. These edges provide no information about the laterality of the grinder. We explain the absence of these non-significant shapes in our experimental programme to the limited experience in the modern ways of making ground axes and the thickness of the preform when it is ground. The thicker it is, the more time is needed to grind the edge, and consequently the forces that cause greater abrasion on the one side are acting for longer. It has been determined that axes whose preforms are made from cobbles with an initial thickness of 3–5 cm suffer more deviation on their edges than axes made from thinner preforms or cobbles less than 3 cm thick. With experience, the effect can be controlled and straight edges produced whatever the initial thickness.

### 5.2.2 Discussion on the results

For a long time, it has been thought that the laterality index of our species is constant in all cultures, and the frequency of left-handed people is about 10% (Annett, 1985). This

was based on studies carried out in Europe and North America, using handwriting as the laterality marker. However, Europe and North America display numerous cultural similarities, due to globalization and, additionally, handwriting in these regions is subjected to high sociocultural pressure. Later studies (Bryden et al., 1993; Holder and Kateeba, 2004; Marchant et al., 1995; Porac and Coren, 1981; Raymond and Pontier, 2004) have shown, however, that laterality displays significant geographic variations. In 1995, Faurie et al. carried out a study on two non-westernized or little-westernized populations (Baka and Bobodioulasso) and on old photographs of two populations that are now westernized (Eipo and Inuit). Laterality among the Baka and Bobodioulasso was assessed by machete use, in the Eipo by archery and in the Inuit, by the handling of tools. Based on these populations, the authors determined that in pre-industrial populations, left-handedness varies from 3.3% (Inuit) to 26.9% (Eipo).

Bearing in mind that in our experimental programme, axes with edges deviated towards the right were always made by a right-handed person, and those with the edge deviated towards the left were made by a left-handed person, the right/left laterality ratio for the Neolithic and Chalcolithic populations who made the archaeological axes that were studied is 7.32/2.68, which is very similar to the range detected by Faurie et al. for modern non-industrial societies, which varied between 9.67/0.33 and 7.31/2.69, and also comparable with the 7.9/2.1 identified in the traditional Himba population in Namibia (Marchant et al., 1995). These studies measured laterality through a single one-handed or two-handed task, by means of which the dominant hand was identified. In the present research, the task of grinding axes has been used, and this fulfils the same condition. However, it should be remembered that laterality varies between tasks that involve the use of tools and those that do not, and that it is seen more clearly in more complex tasks (Healey et al., 1986; Hinckley et al., 1997; Marchant et al., 1995; Provins, 1997b; Steenhuis and Bryden, 1989). Therefore, our results reflect laterality when a certain task is performed (grinding an axe) with a certain level of complexity, undoubtedly less than writing, for example. The method is able to characterize the different types of edges on axes in the archaeological record and associate them with the laterality of the artisan for that particular task and can be used in the future

to study this variable at other sites. To compare handedness ratios obtained in this study with modern ratios, the same criterion and the same task should be used: in this case, grinding an axe as it is likely that individuals in industrial societies like ours will display lower laterality indices for a task like grinding an axe than for writing.

### 5.2.3 Discussion on the application of the method

First of all, by analysing the results of the experimentation, we observe that the influence of the manual dominance of the maker of the axe determines the final form of the cutting edge and its orientation. However, other factors may affect the final form of the edge, although to a lesser extent. For example, the shape of the preform, prepared before grinding the axe, can affect the edge and in some cases produce an edge deviated in the opposite direction. However, according to the experience of experimentation, the grinding phase is usually so intensive that it eliminates this effect. By observing the archaeological materials, we can detect the deviation in the cutting edges and the phenomenon that best explains this effect in the archaeological axes we have studied, according to our experimentation, is the handedness of the maker of the axe.

Therefore, the results obtained in the study of archaeological materials, following the proposed method, need to be assessed with precaution. On one hand, as remarked above, the laterality levels obtained from a given task, such as grinding an axe, may not be comparable with the levels in modern populations, obtained from the study of other kinds of tasks. On the other hand, different factors can influence the deviation of the cutting edge and this may lead to the population-level laterality inferred by this method containing an error. However, it should be stressed that both experimental and archaeological results determine without any doubt that the most significant factor in the deviation of a cutting edge is the handedness of the maker, and that the population-level laterality obtained for prehistoric farming societies are comparable with those of modern non-industrialised societies.

In this way, the study of Chalcolithic and Neolithic polished stone axes from Álava, Bis-

cay and Navarre carried out for this thesis amply fulfils the objectives set out at the start, which was to attempt to understand the way in which archaeological artefacts enable inferences on the laterality of past societies. The way of working developed in this part of the research for the thesis succeeded in correctly approaching prehistoric artefacts and focusing the study of handedness among prehistoric societies coherently in order to obtain quantifiable, reliable and extrapolatable results.

### **5.3 Laterality observed through lithic flakes**

To extend the study of laterality to the Palaeolithic, a method has been developed to be applied to archaeological remains of that age. In this case, it is important that the object of study is abundant in the archaeological record and occurs in large numbers at different sites. One type of object that *a priori* fulfils those conditions is a lithic flake, which can be found in the record whether as knapping waste or as a blank for a tool. Toth (1985) studied the position of cortex on cortical flakes and reached the conclusion that the flakes removed by a right-handed person preserved a portion of cortex on the far right side of the flake, and those removed by a left-handed person on the left. According to Toth this was because a right-handed person turned the core clockwise and a left-handed person anti-clockwise. However, Patterson and Sollberger (1986) showed that this tendency depended on the knapping habits, associated with each individual's way of knapping. Furthermore, according to Pobiner (1999), a left-handed individual can produce flakes with the cortex on the right, and *vice versa*. This shows that to determine the handedness of the knapper, we should ignore the characteristics of the flakes that result from the knapper's personal habits and concentrate on those related to merely mechanical concepts. Rugg and Mullane (2011) carried out a study of the bulbs of percussion on flakes and associated them with the angle of percussion of the knapper, which, they claimed identified the knapper's handedness. They stated that right-handed and left-handed knappers strike a given point on a flint core with an equivalent but opposite angle. Following this line of reasoning, for this thesis we have analysed the process by which flint is fractured during the production of flakes, paying special interest to the moment in which the core is struck with a hammerstone, and obser-



ving the structural elements that might be connected with the knapper's handedness. After preliminary experimentation, and analysing numerous characteristics of the flakes, such as the point of percussion on the butt, the shape of the flake and the symmetry of the butt, we have reached the conclusion that the element that is related to the knapper's handedness is the butt. According to our observations, the only way to identify handedness is through the angle of percussion. Therefore, if some attribute of the flake can be related to the angle and direction of percussion, we can determine the handedness of the person who made the flake.

To find the flake attribute allowing the angle and direction of percussion to be deduced, first of all we analysed the symmetry of the butt and the position of the point of percussion on it. We observed that in some flakes, the point of percussion was not in the middle of the butt but nearer one of the sides. A priori, it seemed logical that the angle, and above all the direction of percussion might cause more stone to be removed in the area behind the point of percussion, following the direction of impact, leading to asymmetric butts with the point of impact away from the middle. If the core was totally symmetrical, and it was struck in a point in the middle of the two sides of the core, it is likely that, in the flake caused by the impact, the position of the point of percussion would be related to the angle and direction of percussion. However, as we observed in our experimentation, an asymmetrical shape of the core influences the position of the point of impact and shape of the butt more than the knapper's handedness. We also analysed the general morphology of the flake and the deviation of the morphological axis from the technological axis. Again, it seems logical, a priori, that this deviation would be related to the direction of percussion and that the flake would conserve more mass on one side, which would cause the deviation of the morphological axis from the technological one. However, once more in this case, the initial morphology of the core is the determinant factor.

These elements, which were studied in the preliminary experimentation, are partly related to the angle and direction of percussion. However, as stated above, the shape of the core in the moment when the flake is removed is sufficient to alter the relationship. In this way, the position of the point of percussion on the butt or the general shape of the flake by them-

selves cannot be considered reliable attributes directly related to the angle of percussion.

Although none of these characteristics on their own could be associated with the knapper's handedness, the experimentation was useful to analyse and understand the phenomenon of lithic reduction from a mechanical point of view and helped to determine that if there was

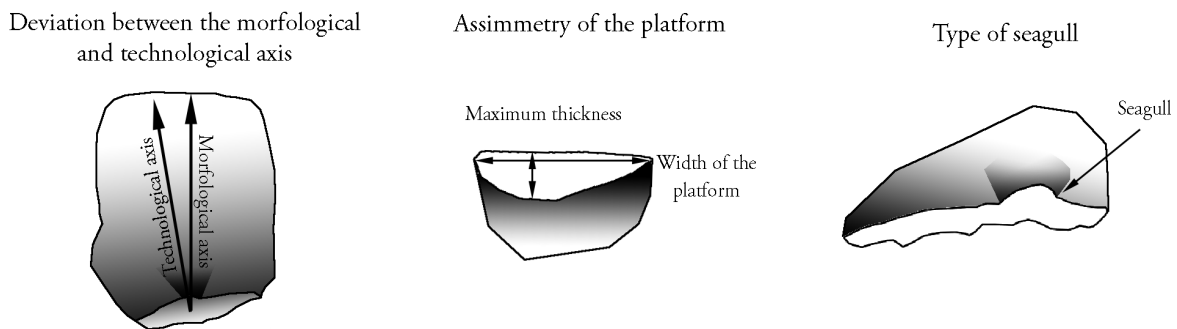

Figure 5.3 Other methods developed in this thesis.

any attribute of the flake that might be clearly related to the direction and angle of percussion, it would be in the butt.

Bargalló and Mosquera (2013) studied a series of flake characteristics, some of which were the same as the ones we analysed, as well as others, like the cone of percussion and parasite flakes, and they also reached the conclusion that the knapper's handedness could not be deduced with those characteristics alone. This included the orientation of the cone of percussion, which had been studied by Rugg and Mullane (2001). However, they developed a method to establish the knapper's handedness by combining all the characteristics. Unfortunately, as not all the flakes display all these attributes, to apply the method they needed several flakes produced by the same knapper. In the study of archaeological materials, this method would be restricted to the study of refits, if we assume that the refitted flakes were all removed by the same individual.

For this thesis, we have sought a method allowing the deduction of the knapper's han-

dedness from a single flake. This would make it possible to study larger archaeological assemblages, without needing to limit the study to refits. Through the observation of lithic reduction, we reached the conclusion that the further we move from the point of percussion of a flake, its structural elements were less and less related to the angle of percussion and, consequently, to the knapper's handedness. In this way, the general shape of the flake and the deviation of the morphological axis are partly related to the angle of percussion, but the shape of the butt is more closely related to it. However, in both cases the relationship is weak and, as remarked above, the initial shape of the core is of greater influence than the knapper's handedness. Therefore, in a second experimentation phase we concentrated on the point of percussion and the structures closest to it. One of these structures is the bulb of percussion, which, as noted above, had been studied by Rugg and Mullane (2001). These authors claim that the bulb of percussion is directly related to the angle of percussion and its direction, and in this way to the knapper's handedness. However, they themselves note the difficulty in measuring its orientation. The bulb of percussion is likely to be more closely connected with the angle of percussion than the other morphological attributes mentioned above. Nonetheless, Bargalló and Mosquera (2013) showed that the relationship is not strong enough to establish the knapper's handedness with it alone. Even nearer the point of impact of the hammerstone on the core, we detected, after numerous knapping sessions, the development of a series of fractures that we called parabolic cracks. Because of their proximity to the point of percussion, they were susceptible to be closely related to the angle and direction of percussion.

To test this relationship, experimentation was carried out at Liverpool University, during a stay of two months, in which a single knapper participated. The experiment consisted of striking a flint platform with a hammerstone in such a way that these cracks were produced, but without removing a flake. The platform was struck in two different directions and the fracture patterns were observed. At first sight, it was noted that the patterns were related to the direction of percussion. However, no individual is able to strike a platform repeatedly with the same direction and, additionally, the core can move during reduction. In this way, to determine whether a real relationship existed between the direction and angle of percus-

sion and the shape of the cracks, and to what extent they were related, a device had to be designed to be able to strike a completely flat flint surface repeatedly with a particular and pre-established direction.

This device was based on a previous design by Dibble and Whittaker (1981). In their research, these authors used a device capable of always striking with the same force, determined by the mass of the percussor and gravitational acceleration, and with a fixed angle, achieved by inclining the flat surface of a fragment of glass. For our experimentation as well as the force and angle, we needed to monitor the direction of percussion, so we had to design a device with a rotary turntable allowing the flat surface, in our case of flint, to be turned in a given direction. This device was used in a series of experiments in which a flint surface was struck with a direction that we established previously. In this way, we were able to determine whether the parabolic cracks were really oriented according to the direction of percussion. The design and functioning of this device is fully described in the Methodology chapter.

Flint was chosen instead of glass for the study of impacts in order to emulate Palaeolithic lithic reduction as closely as possible, as this is rarely in a glass-like material such as obsidian. Glass has often been used in experimentation on the fracturing of flint (e.g. Dibble and Pelcin, 1995; Dibble and Whittaker, 1981; Pelcin, 1997; Roux et al., 2011) as its behaviour is similar and both materials break with conchoidal fractures and glass is easy to obtain and work. However, as our access to flint was relatively good and we were able to work it correctly, we opted for that material. After it had been selected, it was cut to size, obtaining a flat surface where the impacts would be made.

To choose a percussor, we considered the elasticity of the materials. As explained in Chapter 3, we believe that the ability of a percussor to produce parabolic cracks is related to its elasticity; using a percussor made from a hard stone, like limestone or quartzite, it is more likely that these cracks will be produced and when they are, they tend to be larger. The hammerstone chosen for the experimentation was a limestone percussor, which was placed

in the device mentioned above and described in Chapter 3. When the percussor was fitted and the flint placed on the rotary plate, 75 impacts were made, each one with a known direction and angle of percussion.

### 5.3.1 Discussion on the method

Most of the impacts made with a hard hammerstone on a flint surface cause a system of fractures in the shape of a parabola, called parabolic cracks. After studying 75 impacts made with a device that can pre-determine the percussion direction (the percussion machine), it has been established that the axis of symmetry of these cracks coincides with the projection of the percussion direction, with a mean error of  $9.3^\circ$ . This error is due to the parabolic cracks not being completely symmetrical and the direction of their axis of symmetry not being clearly defined. Therefore, several possible lines may define the axis of symmetry of the same parabolic crack. The choice of one or another may cause a maximum error of  $26^\circ$ , with a mean of less than  $10^\circ$  although the error is usually no more than  $5^\circ$ .

These cracks are preserved in the flake butts and their axis of symmetry forms a certain angle with the vertical axis defined by the maximum width of the butt. Bearing in mind the above-mentioned error, it has been determined that the axis of the parabolic cracks skewed to the right of the vertical axis is associated with a right-handed knapper and those skewed to the left, with a left-handed knapper. This is because, in flint knapping, the percussion direction depends on the knapper's handedness. In the case of the two expert knappers who took part in the experimentation, the production of flakes in accordance with their handedness is over 94% (Table 5.2), with each of them producing around a hundred flakes (105 and 77). One of the novice knappers produced a smaller number of flakes (27), of which only 22.2% (six flakes) could be determined correctly. The inexperience of the knapper means that several impacts are often needed to extract a single flake. Consequently superimposed parabolic cracks form, hindering their interpretation. Similarly, as the force of the blow is not controlled well, many flakes break and the possible parabolic cracks are

frequently destroyed. This occurs to the expert knappers too, but less often. The proportion of determinable flakes produced by the experts is always over 25% (table 5.2).

	Expert left-handed		Novice left-handed		Expert right-handed		Novice right-handed	
	N	%	N	%	N	%	N	%
<b>L</b>	27	96,43	5	83,33	2	5,41	3	9,68
<b>R</b>	1	3,57	1	16,67	35	94,59	28	90,32
<b>Indeterminable</b>	77	73,33	21	77,78	40	51,95	60	65,93
<b>Total</b>	105	100	27	100	77	100	91	100

Table 5.5 List of types of flakes made by the knappers and their inferred handedness according to the analysis method.

Out of the total number of flakes, 34% were determinable, and of these only 6.8% were associated with the knapper's handedness wrongly. These flakes were later re-examined, and it was found that the errors were due to two different reasons. First, the flakes extracted by blows in which the knapper struck with the hammerstone facing ahead and not towards himself, or with the core placed frontally, were classed mistakenly as in these cases the percussion angle and direction are those that would normally correspond to a knapper with the opposite handedness. These types of impacts are very unusual in a normal knapping process and often cause knapping errors, which are most common amongst inexpert knappers. Second, the percussion platform may display irregularities when it is struck, and their inclination may modify the impact direction, which is recorded in the parabolic cracks. This is because, when striking with a certain direction on an inclined or very irregular surface, the impact direction depends not only on the angle and direction of the hammerstone, but also on the inclination and direction of the platform. In general, the knapper seeks a flat percussion platform which is placed with the right inclination to strike it comfortably. If this sometimes does not happen, it may be due to inexperience, but even so this phenomenon can be detected when the impact occurs on a rib on dihedral butts, and consequently these

flakes can be classed as indeterminable and eliminated.

### 5.3.2 Discussion on the application of the method

The choice of flakes as the element to be studied signified, a priori, certain advantages in its application. Flakes are abundant at Palaeolithic sites and found at numerous sites. As the method proposed in this thesis may be applied to a single flake, it allows any type of assemblage to be studied, with the sole condition that it contains flakes that conserve the butt and also, to analyse the knapper's handedness, that the fractures called parabolic cracks appear around the point of percussion. As explained in the Methodology chapter, these are found in about 80% of flakes that were removed by direct percussion with a hard hammerstone, without counting punctiform, linear and cortical butts (apart from some exceptions). In the case of punctiform and linear butts there is not sufficient physical space for this type of crack, which needs fairly large butts. In the case of cortical butts, the presence of cracks depends on the nature of the cortex, as in most case its rough texture hampers the appearance of parabolic cracks. Direct percussion was common in the Palaeolithic and the use of hard hammerstones was equally frequent. Even so, not all the cracks of this kind can be studied from the laterality point of view. As noted in the Methodology chapter, what we are measuring to determine the direction of percussion is the axis of symmetry formed by this type of crack. The knapper sometimes needs to strike the core more than once to remove a flake, which means that several generations of parabolic cracks may overlap each other and it is impossible to define their axis of symmetry. Despite displaying parabolic cracks, this type of flake cannot provide information about the knapper's handedness. In addition, as explained in Chapter 3, if the axis of symmetry of the parabola is vertical, taking the width of the butt as the reference for the horizontal plane, or forms an angle of less than  $9.36^\circ$  from the vertical, we cannot deduce whether the flake was removed by a left-handed or right-handed knapper. Thus, in such cases, no information can be deduced about the knapper's handedness.

All other flakes, with well-developed parabolic cracks, can be included in the laterality

study using the method proposed in this thesis. However, there are still some difficulties. First of all, an ideal parabola is completely symmetrical and defining its axis of symmetry is easy and mathematically precise. The axis of symmetry divides the parabola longitudinally in two equal halves. However, the parabola that forms the parabolic cracks is not perfectly symmetrical. Therefore, although the experimenter attempts to define an axis that divides the parabola in two halves as similar as possible, in the case of the parabolic cracks there is no single axis of symmetry, which can lead to a human error in measuring the axis. However, this is not a problem, as to define whether a flake was made by a left-handed or right-handed person, we only have to establish if the axis of symmetry is oriented towards the right or to the left, taking as the reference the vertical axis, which is perpendicular to the width of the butt. By taking the width of the butt as the horizontal axis, we can define a vertical axis that is perpendicular to it and take that as a reference. This vertical axis marks the direction of  $0^\circ$ . As described in Chapter 3, we have defined a shaded arc of  $18.72^\circ$  around this vertical axis ( $9.36^\circ$  on each side of the axis). In fact, this shaded area was defined through the results of the experimentation described in Chapter 3 and comes from the experimental and human error when defining a particular axis of symmetry. All the axes of symmetry forming an angle with the vertical axis on the right side, are considered positive and indicate that the flake was removed by a right-handed person. The axis of symmetry that forms an angle with the vertical axis on the left side are considered negative and indicate that the flake was removed by a left-handed knapper. Therefore, to define the knapper's handedness we only need to know whether the axis of asymmetry is in the positive or negative quadrant (and outside the shaded area around the vertical axis). In this way, although it is difficult to define a particular axis of symmetry, to place it in one of two quadrants is relatively straightforward. In general, as Chapter 3 explains, out of all the flakes removed by a knapper, except the ones with punctiform, linear or cortical butts, the proposed method can be applied in about 33% cases, with a percentage of correct attributions of over 90%. The percentage of remains with parabolic cracks suitable for the study that may be found in an archaeological assemblage is even less, of about 15%, due to processes of conservation, presence of patinas, etc.



5.3.3 Discussion of the results

Population-level laterality have been obtained for prehistoric farming and hunter-gatherer societies by studying archaeological artefacts produced by those societies. The following table compares the population-level laterality of these prehistoric societies with the levels obtained by other authors for modern societies (Table 5.6).

Left-handed %	Country	Task	Method used to measure laterality	References
3,4	Burkina Faso (Bobo-Dioulasso)	Use of machete	Task	Faurie et al. (2005)
5	JapAN	Throw	Questionnaire	Raymond and Pontier (2004)
7	U.S.A	Use of hammer	Task	Plato et al. (1984); Quinan (1930, 1922)
7,1	U.S.A.	Throw	Task	Raymond and Pontier (2004)
8,9	U.K.	Use of hammer	Task	Connolly and Bishop (1992)
10,2	GabOn (Baka)	Use of machete	Task	Faurie et al. (2005)
11,4	Algeria, Côte d'Ivoire, Sudan y U.K.	Use of hammer	Questionnaire	Raymond and Pontier (2004)
12,4	U.K.	Throw	Task	Raymond and Pontier (2004)
15	Papua New Guinea	Use of hammer	Task	Connolly and Bishop (1992)
15	France	Use of hammer	Questionnaire	Raymond and Pontier (2004)
15	Botswana (G /wi San)	Use of tools	Video	Marchant et al. (1995)
16	Venezuela (Yanomamo)	Use of tools	Video	Marchant et al. (1995)
19,6	Papua New Guinea	Throw	Task	Raymond and Pontier (2004)
21	Namibia (Himba tribe)	Use of tools	Video	Marchant et al. (1995)
22	Côte d'Ivoire	Throw	Questionnaire	Raymond and Pontier (2004)
26,8	Farming prehistoric societies (Bizkaia, Álava and Navarra)	Pulish an axe	Arquaeological remains	Dominguez-Ballesteros and Arrizabalaga (2015)
26,9	Indonesia (Eipo tribe)	Use of bow	Photography	Faurie et al. (2005)
30,4	hunter-gatherer prehistoric societies (Axlor, Le Moustier y Vaufrey)	Flint Knapping	Arquaeological remains	Dominguez-Ballesteros and Arrizabalaga

Table 5.6. Summary of the results obtained in the present study and by other authors for modern societies.

Table 5.6 shows that the percentage of left-handed individuals obtained for a prehistoric farming society (26.8%) is not very different from the percentages in modern non-

industrialised societies, such as the Eipo tribe in Indonesia (26.9%), the population of the Ivory Coast (22%), the Himba tribe in Namibia (21%) and the population of Papua New Guinea (19.6%). The percentage of left-handed individuals obtained for hunter-gatherer populations is 30.4%, or 3.6% more left-handed individuals than the farming populations that were studied through polished stone axes. The percentages of left-handed individuals in modern industrialised societies are very different: for example, in Japan (5%) and the USA (7.1%). The tasks used to study handedness are comparable, in our opinion. Throwing, hammering, firing an arrow, grinding an axe, knapping, using a machete or other tools, such as a stick, are not such complex tasks as writing, but they involve the use of some kind of tool.

#### **5.4 General discussion**

One of the most important topics debated in the study of laterality in human beings is whether there is a genetic or cultural influence in laterality and if those two factors affect the manual dominance of an individual and to what extent. It seems clear that there is a genetic factor, although the hereditary mechanisms are complex (Annett, 2009b, 2002, 1994, 1985, 1973, McManus, 1991, 1985; McManus et al., 2013; McManus and Bryden, 1991). Several authors have proposed genetic models for laterality (Annett, 1985; Levy and Nagylaki, 1972; McManus, 1985; Ramaley, 1913). As remarked in Chapter 2, the oldest models are generally characterised by associating an allele for each phenotype. In more recent models, one allele does not produce the specular effect of the other, and therefore the models are intrinsically asymmetric (McManus and Bryden, 1991). These models were proposed by Annett (1985), known as the “Right-Shift Theory”, and by McManus (1985). Both models reflect the biology of asymmetry and asymmetric fluctuation (McManus, 1991). Their differences lie in the conception of the phenotype of handedness (Annett, 1985; McManus, 1985). However, numerous studies also support the idea of an environmental-cultural factor. For example, as noted in Chapter 2, handedness varies depending on geographic origin and socioeconomic status of the population (Connolly and Bishop, 1992; Faurie et al., 2005; Marchant et al., 1995; Raymond and Pontier, 2004). Differences are also found ac-

ording to the task used to measure the handedness of an individual. In principle, the more complex the task, such as a task the involves the use of a tool, the greater the lateralisation of the individual (Healey et al., 1986; Hinckley et al., 1997; Marchant et al., 1995; Provins, 1997b; Steenhuis and Bryden, 1989) and in consequence, the population-level laterality will be more asymmetric.

One of the main objectives of this research has been to analyse the ways in which genetics, culture or environment influence population-level laterality. On the basis of the study of the literature in Chapter 2, archaeological artefacts made by Neolithic and Chalcolithic farming societies and Palaeolithic hunter-gatherer societies have been studied. The following table shows the populational laterality ratios thus obtained for those two societies and for modern non-industrialised societies.

<b>R/L</b>	<b>Country</b>	<b>Task</b>
9,7/0,3	Burkina Faso (Bobo-Dioulasso)	Use of machete
9/1	Gabón (Baka tribe)	Use of machete
8,5/1,5	Botswana (G /wi San tribe)	Use of tools
8,4/1,6	Venezuela (tribu Yanomamo)	Use of tools
8/2	Papua Nueva Guinea	Throw
7,9/2,1	Namibia (tribu Himba)	Use of tools
8,2/2,2	Costa de Marfil	Throw
7,3/2,7	Indonesia (tribu Eipo)	Use of bow
7,3/2,7	Sociedades productoras (Bizkaia, Álava y Navarra)	Polish an axe
7/3	Sociedades cazadoras-recolectoras (Axlor, Le Moustier y Vaufrey)	Flint knapping

Table 5.7 Population-level laterality for prehistoric societies and modern non-industrialised societies.

This table shows that the population-level laterality vary greatly between societies formed by individuals of the same species, such as modern humans. It can also be seen that the prehistoric farming societies resemble the laterality levels in some modern tribes (Eipo tribe). Between these and hunter-gatherer population-level laterality there is a difference, but it is small ( $\pm 0.3$ , with the levels in the prehistoric farming society). In other words,

among populations formed by individuals of the same species (i.e. *Homo sapiens*), such as modern societies and the prehistoric farming society, there is a variation in population-level laterality that is not caused by genetic factors. The levels range from a ratio of 9.7/0.3 (Bobo-Dioulasso) and 9/1 (Baka tribe) to ratios of 7.3/2.7 (prehistoric farming societies and Eipo tribe). In the case of the hunter-gatherer societies studied in this research, formed by individuals of a different human species (*Homo neanderthalensis*), the ratio obtained is slightly different: 7/3. However, this may be a result of the influence of the genetic factor or caused by the cultural difference between farming and hunter-gatherer ways of life.

**Chapter 6:**

# **Conclusions**



This research has concentrated on two main aspects: to develop the methods with which the population-level laterality of prehistoric societies can be inferred, and to use these methods to analyse laterality levels in those societies. Therefore, out of all this work, two types of conclusions can be reached: first, conclusions about the methods proposed and their application to the archaeological record; and, second, conclusions about the results obtained by studying archaeological artefacts with those methods. Additionally, two different methods were developed: one to study Neolithic and Chalcolithic farming societies, based on the analysis of the cutting edge of polished stone axes; and the other to study Palaeolithic hunter-gatherer societies using the butts on lithic flakes. The artefacts that have been studied can also be divided into two groups. First of all, archaeological remains from Neolithic and Chalcolithic sites in Biscay, Álava and Navarre were studied to establish the population-level laterality in prehistoric farming societies, formed by individuals of our own species. Second, archaeological artefacts from the Palaeolithic sites of Le Moustier, Vaufrey and Axlor were studied to determine the population-level laterality in prehistoric hunter-gatherer societies, formed by individuals of a different human species.

## **6.1 Conclusions regarding the polished stone axe method**

The chaîne opératoire involved in making a polished stone axe is well known as some tribes still make these tools today (Toth et al., 1992). The way of making these axes includes a phase in which, to shape the cutting edge, the preform is ground on a static grindstone. As explained in Chapter 3, the maker crouches with the grindstone between his legs and, normally using both hands, begins to grind the preform on the surface of the stone to sharpen one of its edges. To understand the way of making a polished stone axe, we carried out experimentation in which several axes were made, and it was precisely the grinding phase that was reproduced. Based on the observations made on our experimentation with a right-handed individual, due to the centrifugal force generated when the axe is ground on the static stone, as the arm pivots from the shoulder, the axe is ground more on the right-hand side of the plane of the cutting edge being shaped, as seen by the grinder. The inverse effect is produced if the grinder is left-handed and a deviation in the edge of the axe is caused.

The method developed for polished stone axes consists of measuring this deviation of the edge from a horizontal reference axis. According to our experimental results, the morphology of the cutting edge and its deviation depend on the handedness of the maker of the axe (Dominguez-Ballesteros and Arrizabalaga, 2014).

Certainly, other factors can influence the final shape of the cutting edge. A preform with a particular morphology can influence the deviation of the cutting edge considerably. However, the grinding phase is usually effective enough to eliminate that influence. Most of the axes in the archaeological record display a straight cutting edge, and we believe that they deliberately sought that type of edge. Therefore, it can be concluded that, as observed in our experimentation, axes with a deviated edge were generally the result of an effect that was sometimes hard to control when the axe was being made: differential abrasion caused by centrifugal force. Because of this, the method allows laterality in the prehistoric societies that made these tools to be studied satisfactorily.

## **6.2 Conclusions about the lithic flake method**

During the process of lithic reduction, the hammerstone strikes the percussion platform violently. As a result of the impact, a series of cracks usually form around the point of percussion and these are preserved in the flake butt. These fractures, called parabolic cracks, are in the shape of a parabola whose axis of symmetry is aligned depending on the percussion direction. Since left-handed and right-handed people striking the same point in a core hit from opposite directions, and the cracks are recorded in the flake butt, the knapper's handedness can be determined with a high degree of reliability. This method bases its observations on a physical process related to the behaviour of the raw material and, therefore, the results are subject to the physical behaviour of the most usual material in the lithic assemblages of prehistoric hunter-gatherer groups. In addition, the knapper's handedness can be determined in every flake produced, without needing several flakes that are definitely known to have been extracted by the same individual. These circumstances mean that a larger number of remains are susceptible to being studied, and the sizes of the samples can be increased to



reach quantifiable and statistically significant numbers. This method can be applied to any flake, independent of the technique that has been used to remove it (Dominguez-Ballesteros and Arrizabalaga, 2015). Although it may be similar, the production of parabolic cracks in blades and bladelets has not been tested in this work. Since the precision of the method and its great potential for application have been proved experimentally, the handedness index can be calculated quantitatively and statistically for prehistoric communities, both for our own species and for previous human species, such as Neanderthals, based on the observation of this variable in lithic assemblages made from flint.

### **6.3 Conclusions about the results**

As commented in Chapter 2, there are two different concepts within the laterality of a species and they should not be confused. First, individual laterality is the capacity of an individual to carry out a certain task by assigning a different role to each part of the body. Some modern non-human species, such as chimpanzees, display an individual preference for one side of their bodies; that is, they usually prefer to carry out a task using the same side of the body as the dominant side. Second, the concept of population-level laterality is when most of the individuals in a population display the same tendency to assign a given role to one side of the body. Therefore, the individuals of all the groups that display population-level laterality must be lateralised. However, the opposite need not be true: populations whose members display marked individual laterality may not display populational laterality. At the present time, human beings are not the only species displaying individual laterality. However, we are the only species with clear population-level laterality. In this research, we inferred the individual handedness of some members of a society, through the study of archaeological remains, in order to establish the population-level laterality in that society. To detect the population-level laterality of a prehistoric society, an appropriate sample size must be studied. The artefacts chosen in this research fulfil that condition as they formed samples with over 21.85 artefacts, which, as explained in Chapter 4, is the minimum number of elements to be representative of a population.

The following table summarises the results obtained through the application of the two methods developed in this research for prehistoric archaeological remains.

	<b>Sample</b>	<b>L</b>	<b>R</b>	<b>L/R</b>
<b>Farming societies</b>	41	11	30	2,68/7,32
<b>Hunter-gatherer societies</b>	690		480	3,04/6,96

Table 6.1 Sample size, number of elements classed as R and L, and the right-handed/left-handed ratio deduced for each type of prehistoric society.

The handedness ratios for prehistoric farming and hunter-gatherer societies are given in Table 6.1. For the farming society, the sample size was 41 tools, polished stone axes in this case, and for the hunter-gatherer society it was 690 flakes; in both cases the sample size is larger than the minimum representative size. It can therefore be assumed that the handedness ratios in the table correspond to the population-level laterality in the two types of population.

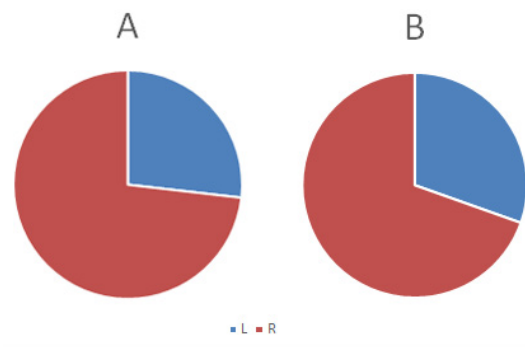

Figure 6.1 Proportion of right-handed (red) and left-handed (blue) individuals in prehistoric farming (A) and hunter-gatherer (B) societies.

Figure 6.1 presents the laterality ratios for farming (A) and hunter-gatherer (B) societies. The proportion of left-handed individuals in Palaeolithic societies is slightly higher than in the farming societies. This result may indicate the influence of the genetic factor, so that the *Homo neanderthalensis* individuals who presumably created the archaeological assemblages that have been studied had a different genetic structure and therefore display a lower lateralisation level. However, it should be recalled that handedness levels measured through two different tasks are being compared: polishing stone axes and lithic reduction. In principle they seem to be equivalent, as they are tasks that involve the use of tools: a static grindstone in the case of grinding axes, and a hammerstone for lithic reduction. Therefore, we believe that the small difference in the proportion of left-handed individuals in the two populations falls within a reasonable fluctuation that will depend more on cultural than genetic differences. If we observe the differences between the Palaeolithic levels that were studied, shown in Table 6.2, it can be seen that the same fluctuations can occur between different hunter-gatherer populations. The results presented in this thesis are absolutely preliminary and above all are able to determine that our methods are applicable to the archaeological record. Future research and studies of more archaeological levels using the methods developed in this thesis will contribute further information that will help to understand the phenomenon of laterality in prehistory better.

Site	Level	Sample	R%	L %
Le Moustier	I	228	70,5	29,5
Le Moustier	J	184	65,2	34,8
Axlor	IV	127	70,9	29,1
Axlor	III	44	77,3	22,7
Axlor	V	32	78,1	21,9
Axlor	VI	29	65,5	34,5
Vaufrey	VII	28	71,4	28,6
Axlor	VII	13	46,2	53,8
Axlor	VIII	5	100	0

Table 6.2 Analysed sample size and proportion of left-handed and right-handed individuals in each archaeological level that has been studied.

As Table 6.2 shows, the Palaeolithic levels are studied one by one and, excluding the levels that do not reach the threshold of 22 specimens fixed as the minimum representative sample size, some variability is seen in the proportion of left-handed individuals. Some levels have given a relatively high proportion of left-handed individuals, such as Level J at Le Moustier and Level VI at Axlor, whereas in others the proportions are relatively low, as in Levels V and II at Axlor. In addition, it should be highlighted that high population-level laterality have been detected among quite old populations, as in Level VII at Vaufrey, which dates to about 200,000 BP, and where the proportion of left-handed individuals is only 28.5%.

The results obtained in this research are what might be expected. The levels detected are slightly lower than recorded by studies on modern industrialised societies and similar to those of non-industrialised societies. Therefore, according to the handedness levels detected in the prehistoric societies formed by *Homo neanderthalensis* individuals, we can deduce that their brain organisation was suitable for the production of articulated language. Although a relationship is known to exist between laterality and language, as described in several chapters of this thesis, it cannot be affirmed that the individuals in the populations studied here possessed language, only that they display evidence of a brain organisation capable of it: laterality.

#### **6.4 Importance of the research for future studies on laterality in Pre-history**

Prehistoric tools are a valuable source of information to learn about the life of our ancestors, and also to understand their behaviour and thoughts. As it is the mind that creates the tool, we can attempt to obtain information about human cognition through the study of lithic assemblages. In this way, the study of prehistoric tools can be completed with an analysis that includes etological and cognitive approaches enabling information to be extracted that is additional to a purely typological study. Following this reasoning, in recent decades, studies analysing handedness in prehistoric populations through lithic assemblages have increased in number. As remarked above, laterality reflects brain asymmetry and is

related, clearly but in a complex way, with language. Based on this premise, our research attempts to contribute information to the study of brain asymmetries and the development of language during our evolution, through the study of laterality.

In this research, in the first place we developed a method to infer handedness with polished stone axes and thus determine laterality in farming societies. In this respect, it is a pioneering study, as no previous attempts have been made to infer laterality through this type of archaeological remains. This method has allowed us to establish laterality levels of prehistoric farming societies satisfactorily. Most research carried out to determine laterality of prehistoric societies has focused on analysing the products of lithic reduction. The first study of handedness with lithic remains was by Semenov (1964), who performed experimental research on manual dominance, but the first full study was by Toth (1985). He claimed that a right-handed knapper turns the core, as flakes are removed, towards the right. In removing the cortex, this habit would tend to produce flakes with the cortex on their right side, whereas a left-handed knapper would result in the opposite effect. However, some years later, Patterson and Sollberger (1986) showed that the original geometry of the core is more important than the direction in which the core is turned after removing a flake and that a left-handed knapper may produce a certain number of right-handed flakes, and vice versa. Later, Pobiner (1999) showed that as the number of flakes increased, the ratio of right-handed/left-handed flakes, according to Toth's nomenclature, approached 50:50. In other words, Toth's method can only be applied to a specific reduction strategy, in which flakes are removed from a single platform following a particular sequence. This means that, if we wish to determine handedness using flakes, the method should not be based on the knapper's working habits. Following this line of reasoning, Rugg and Mullane (2011) later studied the orientation of the cone of percussion on the flake, which is conditioned by the direction of the angle of percussion. They claimed they were able to determine handedness correctly in 75% of the specimens. However, Bargalló et al. (2013) showed that this method alone was not able to determine the knapper's handedness and, by analysing attributes of the flakes, developed another system that was capable of determining handedness with several flakes produced by the same individual. This method is not applicable to each isolated

flake and is restricted to the study of archaeological levels with refitted pieces. To determine the population-level laterality in a society using their lithic remains, the method should be applicable to elements that appear in the archaeological record in large numbers so that the sample is statistically significant. In this research, we have developed a method that is capable of establishing the knapper's handedness with a single flake, through the analysis of some fractures that sometimes form around the point of percussion, called parabolic cracks (Dominguez-Ballesteros and Arrizabalaga, 2015). In this way, it is possible to study an archaeological level with a large enough number of flakes. Using this method, we have examined the Mousterian levels in Le Moustier rock-shelter, Level VII at Grotte Vaufrey and the full sequence from J. M. de Barandiaran's excavation at Axlor. In the future, by studying more archaeological assemblages, this method will allow a better understanding of laterality among past populations and its evolution during the Palaeolithic. It will thus help to understand how brain asymmetries have evolved and contribute information about the origin and development of language in our genus.

## **6.5 Other contributions**

The study of the deviation of cutting edges on polished stone axes can provide little information apart from the handedness of the maker. However, understanding the functioning of centrifugal force while grinding an axe can contribute data to traceological studies of these axes and explain differential abrasion on the cutting edges produced during manufacture, or detect polishing patterns on the static grindstones. This aspect has not been studied in depth in the course of the present research but may be an interesting starting point for future investigations.

The main information parabolic cracks can contribute refers to the knapper's handedness. However, what is really being measured when parabolic cracks are studied is the direction and angle of the impact of a hammerstone on the percussion platform. Therefore, this information may be useful for a better appreciation of the management of raw materials based on the analysis of the mode of percussion, or for a technological study of flake pro-

duction. Knowing the direction and angle with which a flake has been removed can help to understand the process of lithic reduction. Additionally, as explained in Chapter 3, parabolic cracks develop more often and more clearly in flakes removed with a hard, non-elastic, hammerstone than when deer antler is used. If boxwood, a relatively more elastic material, is used, parabolic cracks rarely appear. Therefore, these types of cracks can also help to determine which type of percussor was used to remove a flake.





# Bibliografía



Acosta García, E., 2008. Hacha pulimentada procedente de Suiza: la vida sobre el agua hace 6.000 años. Mus. Cerralbo.

Akelaitis, A.J., 1941. Studies on the corpus callosum II: Higher visual functions in each homonymous visual field following complete section of the corpus callosum. Arch. Neurol. Psychiatry 45, 788–796.

Akelaitis, A.J., 1942. Studies on the corpus callosum V: Homonymous defects for color object and letter recognition (homonymous hemiambyopia) before and after section of the corpus callosum. Arch. Neurol. Psychiatry 48, 108–118.

Akelaitis, A.J., 1943. Studies on the corpus callosum VII: Study of language functions (Tactile and Visual Lexia and Graphia) unilaterally following section of corpus callosum. J. Neuropathol. Exp. Neurol. 2, 226–262.

Akelaitis, A.J., 1944. A study of Gnosis, Praxis and Language Following Section of the Corpus Callosum and Anterior Commissure. J. Neurosurg. 1, 94–102.

Akelaitis, A.J., 1945. Studies on the Corpus Callosum: IV Diagnostic Dyspraxia in epileptics Following Partial and Completion Section of the Corpus Callosum. Am. J. Psychiatry 101, 594–599.

Akelaitis, A.J., Risteen, W.A., Herren, R.Y., Van Wagenen, W.P., 1942. Studies on the Corpus Callosum III: A contribution to the study of dyspraxia and apraxia following partial and complete section of the corpus callosum. Arch. Neurol. Psychiatry 47, 971–1008.

Altuna, J., 1972. Fauna de los mamíferos de los yacimientos de Guipúzcoa. Munibe 24, 1–464.

Altuna, J., 1989. Subsistance d'origine animale pendant le Mousterien dans la region can-

tabrique (Espagne), in: L'Homme de Neandertal. Centenaire de La Découverte de L'homme de Spy. Actes Du Colloque International de Liège. Liège, pp. 41–43.

Andrew, R.J., 1966. Precocious adult behaviour in the young chick. *Anim. Behav.* 14, 256–272.

Andrew, R.J., 1988. The development of visual lateralization in the domestic chick. *Behav. Brain Res.* 14, 201–209.

Andrew, R.J., Rogers, L.J., 2002. *Comparative vertebrate lateralization*. Cambridge University Press, Cambridge.

Annett, M., 1964. A model of the inheritance of handedness and cerebral dominance. *Nature* 204, 59–60.

Annett, M., 1967. The binomial distribution of right, mixed and left handedness. *Q. J. Exp. Physiol.* 19, 327–333.

Annett, M., 1970. Classification of hand preference by association analysis. *Br. J. Psychol.* 61, 303–321.

Annett, M., 1972. The distribution of manual asymmetry. *Br. J. Psychol.* 63, 343–358.

Annett, M., 1973. Handedness in families. *Ann. Hum. Genet.* 37, 93–105.

Annett, M., 1985. *Left, Right, Hand and Brain: the Right Shift Theory*. Lawrence Erlbaum, London.

Annett, M., 1986. *Handedness in Twins : the right shift theory*. Social Statistics Research Unit. London.

Annett, M., 1994. Handedness as a continuous variable with dextral shift: sex, generation, and family handedness in subgroups of left- and right-handers. *Behav. Genet.* 24, 51–63.

Annett, M., 1999. Eye dominance in families predicted by the right shift theory. *Laterality* 4, 37–49.

Annett, M., 2002. *Handedness and brain asymmetry: The right shift theory*. Psychology Press, Hove.

Annett, M., 2009a. Patterns of hand preference for pairs of actions and the classification of handedness. *Br. J. Psychol.* 100, 491–500. doi:10.1348/000712608X357867

Annett, M., 2009b. The Genetic Basis of Lateralization, in: Sommer, C., Kahn, R.S. (Eds.), *Language Lateralization and Psychosis*. Cambridge University Press, Cambridge, pp. 73–86. doi:10.1017/CBO9781107415324.004

Annett, M., Annett, J., 1991. Handedness for eating in gorillas. *Cortex* 27, 269–275.

Annett, M., Kilshaw, D., 1983. Right- and left-hand skill II: Estimating the parameters of the distribution of L-R differences in males and females. *Br. J. Psychol.* 74, 269–283.

Apellániz, J.M., 1965. Monumentos megalíticos de Vizcaya y Álava. *Munibe* 17, 72–86.

Apellániz, J.M., 1971. Los enfermos de la necrópolis de la cueva de Ereñu'ko Arizti (Ereño, Vizcaya). *Kobie* 3, 67–70.

Apellániz, J.M., Nolte y Aramburu, E., 1965. Excavación, estudio y datación por el C 14 de la cueva sepulcral de « Kobeaga » (Ispaster , Vizcaya ). *Munibe* 18, 37–62.

Armour, J.A., Davison, A., McManus, I.C., 2014. Genome-wide association study of handedness excludes simple genetic models. *Heredity (Edinb)*. 112, 221–225.

Arribas, J.L., Berganza, E., 1984. Algunos útiles pulimentados del País Vasco. *Munibe* 36, 59–66.

Auerbach, B.M., Ruff, C.B., 2006. Limb bone bilateral asymmetry: Variability and commonality among modern humans. *J. Hum. Evol.* 50, 203–218.

Aydinlioglu, A.A., Arslanirli, K.A., Ragbetli, M.A., Keles, P., Diyarbakirli, S., 2000. The relationship of callosal anatomy to paw preference in dogs. *Eur. J. Morphol.* 38, 128–133.

Ayuntamiento Abanto-Zierbena, 2013. Del Territorio al Concejo. <http://www.abantozierbena.eus/es-ES/Ayuntamiento/RegistroConvenios/Paginas/concejo.aspx>

Backwell, P.R.Y., Matsumasa, M., Double, M., Roberts, A., Murai, M., Keogh, J.S., Jennions, M.D., 2007. What are the consequences of being left-clawed in a predominantly right-clawed fiddler crab? *Proc. R. Soc. London. Ser. B Biol. Sci.* 274, 2723–2729.

Balari, S., Benítez-Burraco, A., Camps, M., Longa, V.M., Lorenzo, G., Uriagereka, J., 2008. ¿*Homo loquens neanderthalensis*? En torno a las capacidades simbólicas y lingüísticas del Neandertal. *Munibe* 59, 3–24.

Baldeón, A., 1999. El abrigo de Axlor (Bizkaia, País Vasco). Las industrias líticas de sus niveles Musterienses Axlor. *Munibe* 51, 9–121.

Barandiaran, J.M., 1980. Obras Completas. La Gran Enciclopedia Vasca, Bilbao.

Barbeito, R., 1979. Ocular dominance: An explanation based on sighting behavior. York University, Toronto.

Bargalló, A., Mosquera, M., 2013. Can hand laterality be identified through lithic technology? *Laterality* 19, 37–63. doi:10.1080/1357650X.2013.769559

Barth, K.A., Miklosi, A., Watkins, J., Bianco, I.H., Wilson, S.W., Andrew, R.J., 2005. Fsi zebrafish show concordant reversal of laterality of viscera, neuroanatomy, and a subset of behavioral responses. *Curr. Biol.* 15, 844–850.

Basabe, J.M., 1973. Dientes humanos del Musteriense de Axlor. *Trab. Antropol.* 16, 187–207.

Basabe, J.M., 1984. Restos fósiles humanos de la región vasco-cantábrica. *Cuad. Sección. Antropol. Prehistoria-Arqueología.* 1, 67–83.

Beaton, A., 1985. *Left Side Right Side.* Yale University Press, United Kingdom.

Beaton, A., 1997. The relation of planum temporale asymmetry and morphology of the corpus callosum to handedness, gender and dyslexia: a review of the evidence. *Brain Lang* 60, 255–322.

Beck, C.H., Barton, R.L., 1972. Deviation and laterality of hand preference in monkeys. *Cortex* 8, 339–363.

Bermúdez de Castro, J.M., Bromage, T.G., Fernández-Jalvo, Y., 1988. Buccal striations on fossil human anterior teeth: evidence of handedness in the middle and early Upper Pleistocene. *J. Hum. Evol.* 17, 403–412.

Bernal, B., Ardila, A., 2009. The role of the arcuate fasciculus in conduction aphasia.

Brain 132, 2309–2316. doi:10.1093/brain/awp206

Bisazza, A., Rogers, L.J., Vallortigara, G., 1998. The origins of cerebral asymmetry: A review of evidence of behavioural and brain lateralization in fishes, reptiles and amphibians. *Neurosci. Biobehav. Rev.* 22, 411–426.

Bisazza, A., Dadda, M., Facchin, L., Vigo, F., 2007. Artificial selection on laterality in the teleost fish *Girardinus falcatus*. *Behav. Brain Res.* 178, 29–38.

Bisazza, A., Cantalupo, C., Robins, A., Rogers, L.J., Vallortigara, G., 1997. Pawedness and motor asymmetries in toads. *Laterality* 2, 49–64.

Bishop, A., 1964. Use of the hand in lower primates, in: Buettner-Janush, J. (Ed.), *Evolutionary and Genetic Behavior of Primates*. Academic Press.

Blair, B.E., 1955. Physical properties of mine rocks. U. S. Bureau of Mines, U.S.

Bordes, F., 1947. Étude comparative des différentes techniques de taille du silex et des roches dures. *L'Anthropologie* 51, 1–29.

Bordes, F., 1959. Le contexte archéologique des Hommes du Moustier et de Spy. *L'Anthropologie* 63, 154–156.

Bourhis, E. Le, 2008. *Glass: Mechanics and Technology*. Wiley-VCH, Winheim.

Box, H.O., 1977. Observations on spontaneous hand use in the common marmoset (*Callithrix jacchus*). *Primates* 18, 395–400.

Bradshaw, J.L., 1991. Animal asymmetry and human heredity: dextrality, tool use and language in evolution--10 years after Walker (1980). *Br. J. Psychol.* 82, 39–59.



Bradshaw, J.L., Rogers, L.J., 1993. The evolution of lateral asymmetries, language, tool use, and intellect. Academic Press, San Diego.

Bramwell, B., 1899. On “crossed” aphasia and the factors which go to determine whether the “leading” or “driving” speech-centres shall be located in the left right hemisphere of the brain with notes of case of “crossed” aphasia (aphasia with right sided hemiplegia) in a left . *Lancet* 1, 1473–1479.

Brandler, W.M., Morris, A.P., Evans, D.M., Scerri, T.S., Kemp, J.P., Timpson, N.J., Pourcain, B.S., Smith, G.D., Ring, S.M., Stein, J., Talcott, J.B., Fisher, S.E., Webber, C., Paracchini, S., 2013. Common Variants in Left/Right Asymmetry Genes and Pathways Are Associated with Relative Hand Skill. *PLoS Genet.* 9, 1–11. doi:10.1371/journal.pgen.1003751

Brinder, J., 2000. The new neuroanatomy of speech perception. *Brain* 123, 2371–2372.

Brito, G.N., Brito, L.S., Paumgarten, F.J., Lins, M.F., 1989. Lateral preferences in Brazilian adults: an analysis with the Edinburgh Inventory. *Cortex* 25, 403–415.

Broca, P., 1861. Remarques sur le siège de la faculté du langage articulé, suivies d’une observation d’aphémie (perte de la parole). *Bull. la Société d’Anthropologie Paris* 6, 330–357.

Brodman, K., 1909. *Localisation in the Cerebral Cortex*. Springer, Berlin.

Bromage, T.G., Bermúdez de Castro, J.M., Fernández-Jalvo, Y., 1991. The SEM in taphonomic research and its application to studies of cutmarks generally and the determination of handedness specifically. *Anthropol. Brno* 29, 163–169.

Bromage, T.G., Boyde, A., 1984. Microscopic criteria for the determination of directionality cutmarks on bone. *Am. J. Phys. Anthropol.* 65, 359–366.

Brown, J.W., 1975. On the neural organization of language: thalamic and cortical relationships. *BRAIN Lang.* 2, 18–30.

Bryden, M.P., 1977. Measuring handedness with questionnaires. *Neuropsychologia* 15, 617–624.

Bryden, M.P., Ardila, A., Ardila, O., 1993. Handedness in native Amazonians. *Neuropsychologia* 31, 301–308.

Buckner, R.L., Krienen, F.M., Castellanos, A., Diaz, J.C., Yeo, B.T.T., 2011. The organization of the human cerebellum estimated by intrinsic functional connectivity. *J. Physiol.* 106, 2322–2345.

Byrne, R.W., Byrne, J.M., 1991. Hand preference in the skilled gathering tasks of mountain gorillas (*Gorilla g. berengei*). *Cortex* 27, 521–546.

Byrne, R.W., Corp, N., 2003. Acquisition of skilled gathering techniques in Mahale chimpanzees. *Pan Africa News* 10, 4–7.

Byrne, R.W., Corp, N., Byrne, J.M.E., 2001. Manual dexterity in the gorilla: Bimanual and digit role differentiation in a natural task. *Anim. Cogn.* 4, 347–361.

Calhim, S., Birkhead, T.R., 2009. Intraspecific variation in testis asymmetry in birds: Evidence for naturally occurring compensation. *Proc. R. Soc. London. Ser. B Biol. Sci.* 276, 2279–2284.

Calvin, W.H., 1983. *The throwing madonna: essays on the brain.* McGraw-Hill, New York.

Carrière, S., Raymond, M., 2000. Handedness and aggressive behavior in an Ntumu village in southern Cameroon. *Acta Ethol.* 2.

Cashmore, L., Uomini, N.T., Chapelain, A., 2008. The evolution of handedness in humans and great apes: a review and current issues. *J. Anthropol. Sci.* 86, 7–35.

Castañares, L.M., Robles, S., Vicente Bravo, J.C., 1997. Distribución estratigráfica de los episodios volcánicos submarinos del Albiense-Santoniense en la Cuenca Vasca (sector Gernika-Plentzia, Bizkaia). *Geogaceta* 22, 43–46.

Chamberlain, H.D., 1928. The inheritance of left handedness. *J. Hered.* 19, 557–559.

Chen, J.N., van Bebber, F., Goldstein, A.M., Serluca, F.C., Jackson, D., Childs, S., Serbedzija, G., Warren, K.S., Mably, J.D., Lindahl, P., Mayer, A., Haffter, P., Fishman, M.C., 2001. Genetic steps to organ laterality in zebrafish. *Comp. Funct. Genomics* 2, 60–68.

Clapham, P., 2004. Right whales: natural history and conservation. Baxter Press, United Kingdom.

Clark, B., Warren, N., 1938. A consideration of the use of the term ocular dominance. *Psychol. Bull.* 35, 298–304.

Clark, M.M., 1957. Left-handedness. University of London Press, London.

Clarkson, C., 2007. Lithics in the Land of the Lightning Brothers: The Archaeology of Wardaman Country, Northern Territory. Australian National University E Press, Canberra.

Coates, D.F., Parsons, R.C., 1966. Experimental criteria for classification of rock substances. *Int. J. Rock Mech. Min. Sci.* 3, 181–189.

Cole, J., 1955. Paw preference in cats related to hand preference in animals and man. *J. Comp. Physiol. Psychol.* 48, 137–140.

Colell, M., Segarra, M.D., Pi, J.S., 1995. Hand preferences in chimpanzees (*Pan troglodytes*), bonobos (*Pan paniscus*), and orangutans (*Pongo pygmaeus*) in food-reaching and other daily activities. *Int. J. Primatol.* 16, 413–434.

Connolly, K.J., Bishop, D. V, 1992. The measurement of handedness: a cross-cultural comparison of samples from England and Papua New Guinea. *Neuropsychologia* 27, 893–897. doi:10.1016/0028-3932(92)90010-J

Coons, J.C., Mathias, R.J., 1928. Eye and hand preferences tendencies. *J. Genet. Psychol.* 35, 629–632.

Corballis, M.C., 2005. From mouth to hand: Gesture, speech, and the evolution of right-handedness. *Behav. Brain Sci.* 26, 199–260.

Corballis, M.C., 2003. From mouth to hand: gesture, speech, and the evolution of right-handedness. *Behav. Brain Sci.* 26, 199–260.

Coren, S., 1992. *The Left-Hander Syndrome: the Causes and Consequences of Left-Handedness*. Free Press, New York.

Coren, S., Kaplan, C.P., 1973. Patterns of ocular dominance. *Am. J. Optom. Physiol. Opt.* 50, 283–292.

Coren, S., Porac, C., 1975. Ocular dominance: An annotated bibliography. *J. Suppl. Abstr. Serv. Cat. Sel. Doc. Psychol.* 5, 229–230.

Coren, S., Porac, C., Duncan, P., 1979. A behaviorally-validated self-report inventory to

assess four types of lateral preference. *Clin. Neurophysiol.* 1, 55–64.

Corey, D.M., Hurley, M.M., Foundas, A.L., 2001. Right and left handedness defined: a multivariate approach using hand preference and hand performance measures. *Neuropsychiatry. Neuropsychol. Behav. Neurol.* 14, 144–152.

Coriolis, G.G., 1835. Sur les équations du mouvement relatif des systèmes de corps. *J. l'Ecole R. Polytech.* 15, 144–154.

Corp, N., Byrne, R.W., 2004. Sex difference in chimpanzee handedness. *Am. J. Phys. Anthropol.* 123, 62–68.

Cotterell, B., Kamminga, J., 1987. Society for American Archaeology The Formation of Flakes. *Am. Antiq.* 52, 675–708.

Cotterell, B., Kamminga, J., Dickson, F.P., 1985. The essential mechanics of conchoidal flaking. *Int. J. Fract.* 29, 205–221.

Cowan, W.M., Adamson, L., Powell, T.P., 1961. An experimental study of the avian visual system. *J. Anat.* 95, 545–563.

Crovitz, H.F., 1961. Differential acuity of the two eyes and the problem of ocular dominance. *Science.* 134, 614.

Crovitz, H.F., Zener, K., 1962. A group-test for assessing hand and eye dominances. *Am. J. Psychol.* 75, 271–276.

Cuff, N., 1931. A study of eyedness and handedness. *J. Exp. Psychol.* 14, 164–175.

Currey, J.D., Landete-Castillejos, T., Estevez, J.A., Olguin, A., Garcia, A.J., Gallego, L.,

2009. The Young's Modulus and Impact Energy Absorption of Wet and Dry Deer Cortical Bone. *Open Bone J.* 1, 38–45.

Dadda, M., Bisazza, A., 2006. Does brain asymmetry allow efficient performance of simultaneous tasks? *Anim. Behav.* 72, 523–529.

Danforth, M.E., Thomson, A., 2008. An evaluation of determination of handedness using standard osteological measurements. *J. Forensic Sci.* 53, 777–781.

Dapretto, M., Bookheimer, S.Y., 1999. From and content: dissociating syntax and semantics in sentence comprehension. *Neuron* 24, 427–432.

Dax, M., 1836. Lésions de la moitié gauche de l'encephale coincident avec l'oubli des signes de la pensée, in: Dax, G. (Ed.), *L'aphasie*. Montpellier.

De Agostini, M., Khamis, A.H., Ahui, A.M., Dellatolas, G., 1997. Environmental influences in hand preference: an African point of view. *Brain Cogn.* 35, 151–67. doi:10.1006/brcg.1997.0935

Dejerine, J., 1892. Contribution a l'étude anatomo-pathologique et clinique des différentes variétés de cécité verbale. *Mem. la société Biol.* 4, 61–90.

Dellatolas, G., De Agostini, M., Jallon, P., Poncet, M., Rey, M., Lellouch, J., 1988. Mesure de la préférence manuelle par autoquestionnaire dans la population française adulte. *Rev. Psychol. Appliquée* 38, 117–136.

Delpech, F., 1988. Les Grandes Mammifères, à l'Exception des Ursides, in: Rigaud, J.-P. (Ed.), *La Grotte Vaufréy: Paléoenvironnements, Chronologie, Activités Humanies*. *Mémoires de la Société Préhistorique Française* 19, pp. 213–289.

Desmond, J.E., Sum, J.M., Wagner, A.D., Demb, J.B., Shear, P.K., Glover, G.H., Gabrieli, J.D., Morrell, M.J., 1995. Functional MRI measurement of language lateralization in Wada-tested patients. *Brain* 118, 1411–1419.

Deuel, R.K., Dunlop, N.L., 1980. Hand preference in the rhesus monkey: Implications for the study of cerebral dominance. *Arch. Neurol.* 37, 217–221.

Deutsch, G., Bourbon, W.T., Papanicolaou, A.C., Eisenberg, H.M., 1988. Visuospatial task compared via activation of regional cerebral blood flow. *Neuropsychologia* 26, 445–452.

Dibble, H.L., Pelcin, A., 1995. The Effect of Hammer Mass and Velocity on Flake Mass. *J. Archaeol. Sci.* 22, 429–439.

Dibble, H.L., Whittaker, J.C., 1981. New experimental evidence on the relation between percussion flaking and flake variation. *J. Archaeol. Sci.* 8, 283–296.

Dominguez-Ballesteros, E., Arrizabalaga, A., 2015. Flint knapping and determination of human handedness. Methodological proposal with quantifiable results. *J. Archaeol. Sci. Reports* 3, 313–320. doi:10.1016/j.jasrep.2015.06.026

Dominguez-Ballesteros, E., Arrizabalaga, A., 2014. Laterality in the first Neolithic and Chalcolithic farming communities in northern Iberia. *Laterality* 20, 371–387. doi:10.1080/1357650X.2014.982130

Donald, M., 1991. *Origins of the Modern Mind: Three Stage in the Evolution of Culture and Cognition*. Harvard University Press, Cambridge (Massachusetts).

Downey, J.E., 1933. Laterality of function. *Psychol. Bull.* 30, 109–142.

Driscoll, K., 2010. Understanding quartz technology in early prehistoric Ireland. University College Dublin.

Driscoll, K., García-Rojas, M., 2014. Their lips are sealed: identifying hard stone, soft stone, and antler hammer direct percussion in Palaeolithic prismatic blade production. *J. Archaeol. Sci.* 47, 134–141.

Dunbar, R., 1996. *Grooming, Gossip, and the Evolution of Language*. Harvard University Press, Cambridge (Massachusetts).

Eberstaller, O., 1884. Zür Oberflächen Anatomie der Grosshirn Hemisphaeren. *Wiener Medizinische Blätter* 7, 642–647.

Estavillo, D., 1975. Contribución a la prehistoria del País Vasco. Los hallazgos líticos de la zona de Araico; un poblado protohistórico en Portilla la Alta y otros datos de arqueología treviñesa. *Estud. Arqueol. Álavesa* 8, 11–85.

Ettlinger, G., 1961. Lateral preferences in monkeys. *Behaviour* 17, 275–287.

Ettlinger, G., Moffett, A., 1964. Lateral preferences in the monkey. *Nature* 204, 606.

Evarts, E. V., Thach, W.T., 1969. Motor mechanisms of the CNS: Cerebrocerebellar interrelations. *Annu. Rev. Physiol.* 31, 451–498.

Fabre-Thorpe, M., Fagot, J., Levesque, E., Vauclair, J., 1993. Laterality in cats: Paw preference and performance in a visuomotor activity. *Cortex* 29, 15–24.

Fagot, J., Vauclair, J., 1991. Manual laterality in nonhuman primates: A distinction between handedness and manual specialization. *Psychol. Bull.* 109, 76–89.



Fagot, J., Vauclair, J., 1988. Handedness and bimanual coordination in the lowland gorilla. *Brain. Behav. Evol.* 32, 89–95.

Falk, D., 1987. Brain lateralization in primates and its evolution in hominids. *Yearb. Phys. Anthropol.* 30, 107–125.

Falk, D., Pyne, L., Helmkamp, R.C., DeRousseau, C.J., 1988. Directional asymmetry in the forelimb of *Macaca mulatta*. *Am. J. Phys. Anthropol.* 77, 1–6.

Fandos, A.J., 1973. Nota preliminar para una tipología analítica de las hachas pulimentadas. *Munibe.* 2-4, 203–208.

Farmer, I.W., 1968. *Engineering Properties of Rocks*. E. and FN Spon Ltd., London.

Faurie, C., Raymond, M., 2004. Handedness frequency over more than ten thousand years. *Proc. R. Soc. London B* 271, S43–S45.

Faurie, C., Raymond, M., 2013. The fighting hypothesis as an evolutionary explanation for the handedness polymorphism in humans: Where are we? *Ann. N. Y. Acad. Sci.* 1288, 110–113.

Faurie, C., Schiefenhövel, W., Le Bomin, S., Billiard, S., Raymond, M., 2005. Variation in the Frequency of Left-handedness in Traditional Societies. *Curr. Anthropol.* 46, 142–147.

Fernández Eraso, J., Eguiluz Alarcón, L., Tarrío, A., 2003. Nuevos instrumentos pulimentados procedentes de conjuntos de superficie en el territorio de Álava. *Estud. Arqueol. Alavesa* 20, 10–41.

Finch, G., 1941. Chimpanzee handedness. *Science.* 94, 117–118.

Fink, W.H., 1938. The dominant eye: Its clinical significance. *Arch. Ophthalmol.* 19, 555–582.

Fischer, R.B., Meunier, G.F., White, P.J., 1982. Evidence of laterality in the lowland gorilla. *Percept. Mot. Skills* 54, 1093–1094.

Flourens, P., 1824. Recherches expérimentales sur les propriétés et les fonctions du système nerveux dans les animaux vertébrés, in: Clarke, E., O'Malley, C. (Eds.), *The Human Brain and Spinal Cord*. University of California Press, Berkeley.

Frank, F.C., Lawn, B.R., 1967. On the theory of Hertzian fracture. *Proc. R. Soc. London* 299, 291–306.

Fruyer, D.W., Lozano, M., Bermúdez de Castro, J.M., Carbonell, E., Arsuaga, J.L., Radovicic, J., Fiore, I., Bondioli, L., 2011. More than 500,000 years of right-handedness in Europe. *Laterality* 17, 51–69. doi:10.1080/1357650X.2010.529451

Fruyer, D.W., Clarke, R.J., Fiore, I., Blumenschine, R.J., Erez-P Erez, A.P., Martinez, L.M., Estebananz, F., Holloway, R., Bondioli, L., 2016. OH-65: The earliest evidence for right-handedness in the fossil record 100, 65–72. doi:10.1016/j.jhevol.2016.07.002

Friedlander, W.J., 1971. Some aspects of eyedness. *Cortex* 7, 357–371.

Friedman, M., 2008. The evolutionary origin of flatfish asymmetry. *Nature* 454, 209–212.

Frost, G.T., 1980. Tool behavior and the origins of laterality. *J. Hum. Evol.* 9, 447–459.

Gahagan, L., 1933. Visual dominance-acuity relationship. *J. Gen. Psychol.* 9, 455–459.

Gall, O. Le, 1988. Les Poissons, in: Rigaud, J.-P. (Ed.), *La Grotte Vaufray: Paléoenvironnements, Chronologie, Activités Humaines*. *Memoires de la Societe Prehistorique Française*. 19, pp. 351–356.

Gardner, M., 2005. *The new ambidestrous universe: Symmetry and asymmetry from mirror reflections to superstrings*. Dover, Mineola.

Gautrin, D., Ettlinger, G., 1970. Lateral preferences in the monkey. *Cortex* 6, 287–292.

Gazzaniga, M.S., Bogen, J.E., Sperry, R.W., 1965. Observations on visual perception after disconnexion of the cerebral hemispheres in man. *Brain* 88, 221–236.

Geschwind, D.H., Miller, B.L., DeCarli, C., Carmelli, D., 2002. Heritability of lobar brain volumes in twins supports genetic models of cerebral laterality and handedness. *Proc. Natl. Acad. Sci. U. S. A.* 99, 3176–3181. doi:10.1073/pnas.052494999

Geschwind, N., 1974. The anatomical basis of hemispheric differentiation, in: Dimond, S.J., Beaumont, J.G. (Eds.), *Hemisphere Function in the Human Brain*. Elek, London.

Geschwind, N., 1970. The organization of language and the brain. *Science*. 170, 940–944.

Geschwind, N., Levitsky, W., 1968. Human brain: left-right asymmetries in temporal speech region. *Science*. 161, 186–187.

Gilbert, A.N., Wysocki, C.J., 1992. Hand preference and age in the United States. *Neuropsychologia* 30, 601–608.

Glickstein, M., 2007. What does the cerebellum really do? *Curr. Biol.* 17.

Goodall, J., 1964. Tool-using and aimed throwing in a community of free-living chimpanzees. *Nature* 201, 1264–1266.

Grayson, D.K., Delpech, F., 1994. The Evidence for Middle Palaeolithic Scavenging from Couche VIII, Grotte Vaufray (Dordogne, France). *J. Archaeol. Sci.* 21, 359-375. doi:10.1006/jasc.1994.1035

Griffith, A.A., 1920. The Phenomena of Rupture and Flow in Solids. *Philos. Trans. R. Soc. London* 221, 163–198.

Groënen, M., 1988. Les representations de mains negative dans le grottes de Gargas et de Tibiran. *Bull. la Société R. Belge d'Anthropologie Prehistoire.* 99, 81–113.

Gronwall, D.M.A., Sampson, H., 1971. Ocular dominance: a test of two hypotheses. *Br. J. Psychol.* 62, 175–185.

Guiard, Y., 1987. Asymmetric division of labor in human skilled bimanual action: The kinematic chain as a model. *J. Mot. Behaviour.* 19, 486–517.

Gursoy, R., 2009. Effects of left- or right-hand preference on the success of boxers in Turkey. *Br. J. Sports Med.* 43, 142–144.

Güven, M., Elalmis, D., Binokay, S., Tan, U., 2003. Population-level right-paw preference in rats assessed by a new computerized food-reaching test. *Int. J. Neurosci.* 113, 1675–1689.

Häberling, I.S., Corballis, M.C., 2015. Cerebellar asymmetry, cortical asymmetry and handedness: Two independent networks. *Laterality* 1–18. doi:10.1080/1357650X.2015.1110161

Halliday, D., Resnick, R., Walker, J., 2010. *Fundamentals of physics extended*. John Wiley & Sons.

Halpern, M.E., Liang, J.O., Gamse, J.T., 2003. Leaning to the left: Laterality in the zebrafish forebrain. *Trends Neurosci.* 26, 308–313.

Harding, P., 1983. An experiment to produce a ground flint axe, in: Sieveking, G. de G., Newcomer, M.H. (Eds.), *The Human Uses of Flint and Chert*. Cambridge University Press, Cambridge, pp. 37–42.

Hardyck, C., Goldman, R., Petrinovich, L., 1975. Handedness and sex, race and age. *Hum. Biol.* 47, 369–375.

Harris, L.J., 1992. Left-handedness, in: Rapin, I., Segalowitz, S.J. (Eds.), *Handbook of Neuropsychology*. Elsevier, Amsterdam, pp. 145–208.

Harrison, R.M., Nystrom, P., 2010. Handedness in captive gorillas (*Gorilla gorilla*). *Primates* 51, 251–261.

Harrison, R.M., Nystrom, P., 2008. Handedness in captive bonobos (*Pan paniscus*). *Folia Primatol.* 79, 253–268.

Hauser, O., 1909. Découverte d'un squelette du type du Néandertal sous l'abri inférieur du Moustier. *L'Homme Préhistorique* 7, 1–19.

Healey, J.M., Liederman, J., Geschwind, N., 1986. Handedness is not a unidimensional trait. *Cortex* 22, 33–53.

Heestand, J.E., 1986. Behavioral lateralization in four species of apes? Washington University.

Heidari, M., Khanlari, G.R., Momeni, A.A., 2010. Prediction of Elastic Modulus of Intact Rocks Using Artificial Neural Networks and non-Linear Regression Methods. *Aust. J. Basic Appl. Sci.* 4, 5869–5878.

Helmkamp, R.C., Falk, D., 1990. Age- and sex-associated variations in the directional asymmetry of rhesus macaque forelimb bones. *Am. J. Phys. Anthropol.* 83, 211–218.

Herculano-Houzel, S., 2012. The remarkable, yet not extraordinary, human brain as a scaled-up primate brain and its associated cost. *Proc. Natl. Acad. Sci. United States Am.* 109, 10661–10668.

Hernandez, M., Mercier, N., Rigaud, J.-P., Texier, J.-P., Delpech, F., 2014. A revised chronology for the Grotte Vaufray (Dordogne, France) based on TT-OSL dating of sedimentary quartz. *J. Hum. Evol.* 75, 53–63.

Hertz, H., 1882. *Verhandlungen des Vereins zur Beförderung des Gewerbefleisses*. Leipzig.

Hildreth, G.J., 1949. The development and training of hand dominance. *J. Genet. Psychol.* 75, 221–275.

Hinckley, K., Pausch, R., Proffitt, D., Patten, J., Kasselli, N., 1997. Cooperative bi-manual action, in: *ACM CHI'97 Conference on Human Factors in Computing Systems*. ACM New York, Atlanta, pp. 27–34.

Hinkovska, V.T., Dimitrov, G.P., Koumanov, K.S., 1986. Phospholipid composition and phospholipid asymmetry of ram spermatozoa plasma membranes. *Int. J. Biochem.* 18,

331–339.

Holder, M.K., Kateeba, D., 2004. Hand preference survey of 5,136 school children in Western Uganda. *Laterality* 9, 201–207.

Hopkins, W.D., 2013. Comparing Human and Nonhuman Primate Handedness: Challenges and a Modest Proposal for Consensus. *Dev. Psychobiol.* 55, 621–636. doi:10.1002/dev.21139

Hopkins, W.D., 1995. Hand preferences for a coordinated bimanual task in 110 chimpanzees (*Pan troglodytes*): cross-sectional analysis. *J. Comp. Psychol.* 109, 291–297. doi:10.1037/0735-7036.109.3.291

Hopkins, W.D., 1994. Hand preferences for bimanual feeding in 140 captive chimpanzees (*Pan troglodytes*): Rearing and ontogenetic determinants. *Dev. Psychobiol.* 27, 395–407.

Hopkins, W.D., 1993. Posture and reaching in chimpanzees (*Pan Troglodytes*) and orangutans (*Pongo pygmaeus*). *J. Comp. Psychol.* 107, 162–168.

Hopkins, W.D., Bennett, A.J., Bales, S.L., Lee, J., Ward, J.P., 1993. Behavioral laterality in captive bonobos (*Pan paniscus*). *J. Comp. Psychol.* 107, 403–410.

Hopkins, W.D., DeWaal, F.B.M., 1995. Behavioral laterality in captive bonobos (*Pan paniscus*): replication and extension. *Int. J. Primatol.* 16, 261–276.

Hopkins, W.D., Pearson, K., 2000. Chimpanzee (*Pan Troglodytes*) handedness: Variability across multiple measures of hand-use. *J. Comp. Psychol.* 114, 126–135.

Hopkins, W.D., Phillips, K.A., Bania, A., Calcutt, S.E., Gardner, M., Russell, J., Schaeffer, J., Lonsdorf, E. V, Ross, S.R., Schapiro, S.J., 2011. Hand preferences for coordinated

bimanual actions in 777 great apes: Implications for the evolution of handedness in Hominins. *J. Hum. Evol.* 60, 605–611. doi:10.1016/j.jhevol.2010.12.008

Hopkins, W.D., Russell, J.L., Hostetter, A., Pilcher, D., Dahl, J.F., 2005. Grip preference, dermatoglyphics, and hand use in captive chimpanzees (*Pan troglodytes*). *Am. J. Phys. Anthropol.* 128, 57–62.

Hopkins, W.D., Russell, J.L., Schaeffer, J.A., Gardner, M., Schapiro, S.J., 2009. Handedness for tool use in captive chimpanzees (*Pan troglodytes*): sex differences, performance, heritability and comparison to the wild. *Behaviour* 146, 1463–1483.

Hopkins, W.D., Stoinski, T.S., Lukas, K.E., Ross, S.R., Wesley, M.J., 2003. Comparative assessment of handedness for a coordinated bimanual task in chimpanzees (*Pan troglodytes*), gorillas (*Gorilla gorilla*) and orangutans (*Pongo pygmaeus*). *J. Comp. Psychol.* 117, 302–308. doi:10.1021/ja8019214.Optimization

Horn, G., Johnson, M.H., 1989. Memory systems in the chick: Dissociations and neuronal analysis. *Neuropsychologia* 27, 1–22.

Horn, G., Rose, S.P., Bateson, P.P., 1973. Monocular imprinting and regional incorporation of tritiated uracil into the brains of intact and “slip-brain” chicks. *Brain Res.* 56, 227–237.

Hosking, J.R., 1955. A comparison of the diametral tensile strength, the flexural strength, and the compressive strength of two new core materials to a silver alloy-reinforced glass-ionomer material. *Quarr. Manag. J.* 39, 200–212.

Howard, I.P., 2002. Seeing in depth: Vol. 1. Basic mechanism. I. Porteous, Toronto.

Howard, I.P., Rogers, B.J., 2012. Perceiving in depth: Vol. 2. Stereoscopic vision. Oxford



University Press, New York.

Itani, J., 1957. Personality of Japanese monkeys. *Iden* 11, 29–33.

Itani, J., Tokuda, K., Furuya, Y., Kano, K., Shin, Y., 1963. The social construction of natural troops of Japanese monkeys in Takasakyama. *Primates* 4, 1–42.

Jackson, J.H., 1868. Defect of intellectual expression (aphasia) and left hemiplegia. *Lancet* 457.

Jimenez-Guijarro, J., 2010. *Cazadores y campesinos. La neolitización del interior de la Península Ibérica*. Real Academia de la Historia, Madrid.

Jordan, H.E., 1911. The inheritance of left-handedness. *Am. Breeders Mag.* 2, 19–29.

Kertesz, A., Black, S.E., Polk, M., Howell, J., 1986. Cerebral asymmetries on magnetic resonance imaging. *Cortex* 22, 117–127.

Kervazo, B., Laville, H., 1988. Etude Stratigraphique et Analyse Physico-chimique des Depots de la Grotte Vaufrey, in: Rigaud, J.-P. (Ed.), *La Grotte Vaufrey: Paléoenvironnements, Chronologie, Activités Humaines*. Mémoires de la Société préhistorique française 19, pp. 89–153.

Kimura, D., 1979. *Neuromotor mechanisms in the evolution of human communication*. Academic Press.

Kitterle, F.L., 1991. *Cerebral laterality: Theory and research: The Toledo symposium*. Lawrence Erlbaum Associates, Hillsdale.

Klingenberg, C.P., McIntyre, G.S., Zaklan, S.D., 1998. Left-right asymmetry of fly wings

and the evolution of body axes. *Proc. R. Soc. London. Ser. B Biol. Sci.* 265, 1255–1259.

Knecht, S., Deppe, M., Dräger, B., Bobe, L., Lohmann, H., Ringelstein, E.-B., Henningsen, H., 2000a. Language lateralization in healthy right-handers. *Brain* 123, 74–81.

Knecht, S., Deppe, M., Ringelstein, E.B., Wirtz, M., Lohmann, H., Dräger, B., Huber, T., Henningsen, H., 1998. Reproducibility of functional transcranial Doppler sonography in determining hemispheric language lateralization. *Stroke*. 29, 1155–1159. doi:10.1161/01.STR.29.6.1155

Knecht, S., Deppe, M., Dräger, B., Bobe, L., Lohmann, H., Ringelstein, E.B., Henningsen, H., 2000a. Language lateralization in healthy right-handers. *Brain* 123, 74–81.

Knecht, S., Dräger, B., Deppe, M., Bobe, L., Lohmann, H., Floel, A., Ringelstein, E.B., Henningsen, H., 2000b. Handedness and hemispheric language dominance in healthy humans. *Brain* 123, 2512–2518. doi:10.1093/brain/123.12.2512

Kolb, B., Sutherland, R.J., Noneman, A.J., Whishaw, I.Q., 1982. Asymmetry in the cerebral hemispheres of the rat, mouse, rabbit, and cat: The right hemisphere is larger. *Exp. Neurol.* 78, 348–359.

Komai, T., Fukuoka, G., 1934. A study on frequency of left-handedness and left-footedness among the Japanese school children. *Hum. Biol.* 6, 33–42.

Kounin, J.S., 1938. Laterality in monkeys. *J. Genet. Psychol.* 52, 375–393.

Kozak, V., Baxter, D., Williamson, L., Carneiro, R.L., 1979. The Heta Indians: Fish in a dry pond. *Anthropol. Pap. Am. Mus. Nat. Hist.* 55, 349–434.

Kretschmann, D.E., 2010. Mechanical Properties of Wood, in: *Wood Handbook: Wood*

as an Engineering Material. General Technical Report FPL-GTR-190. US Department of Agriculture.

Krutch, J.W., 1952. *The desert year*. Sloane, New York.

Laville, H., Rigaud, J.-P., 1973. L'abri inférieur du Moustier (Dordogne): précisions stratigraphiques et chronologiques. *Comptes Rendus l'Académie des Sci.* 276, 3097–3100.

Lawn, B., Wilshaw, T.R., 1975. *Fracture of Brittle Solids*. Cambridge University Press, Cambridge.

Lazenby, R.A., 2002. Skeletal Biology, Functional Asymmetry and the Origins of “Handedness.” *J. Theor. Biol.* 218, 129–138. doi:10.1006/yjtbi.3052

Lehman, R.A., 1980. Distribution and changes in strength of hand preference of cynomolgus monkeys. *Brain. Behav. Evol.* 17, 209–217.

Leiber, L., Axelrod, S., 1981. Intra-familial learning is only a minor factor in manifest handedness. *Neuropsychologia* 19, 273–288.

LeMay, M., Kido, D.K., 1978. Asymmetries of the cerebral hemispheres on computed tomograms. *J. Comput. Assist. Tomogr.* 2, 471–476.

Levander, M., Schalling, D., 1988. Hand preference in a population of Swedish college students. *Cortex* 24, 149–156.

Levy, J., 1969. Possible basis for the evolution of lateral specialization of the human brain. *Nature* 224, 614–615.

Levy, J., Nagylaki, T., 1972. A model for the genetics of handedness. *Genetics* 72, 117–

128.

Lieberman, P., 1984. *The biology and Evolution of language*. Harvard University Press, Cambridge.

Lieberman, P., Crelin, E.S., 1971. On the speech of Neanderthal man. *Linguist. Inq.* 2, 203–222.

Lieberman, P., Crelin, E.S., Klatt, D.H., 1972. Phonetic ability and related anatomy of the newborn and adult human, Neanderthal Man, and the chimpanzee. *Am. Anthropol.* 74, 287–307.

Lieberman, P., Laitman, J.T., Reidenberg, J.S., Gannon, P.J., 1992. The anatomy, physiology, acoustics and perception of speech: essential elements in analysis of the evolution of human speech. *J. Hum. Evol.* 23, 447–467.

Llaurens, V., Raymond, M., Faurie, C., 2009. Why are some people left-handed? An evolutionary perspective. *Philos. Trans. R. Soc. B Biol. Sci.* 364, 881–894. doi:10.1098/rstb.2008.0235

Llorente, M., Fabr , M., Mosquera, M., 2008. Lateralizaci  cerebral en chimpanc s: una aproximaci  filogen tica al estudio del cerebro humano. *Estud. Psicol.* 29, 147–161.

Lonsdorf, E. V., Hopkins, W.D., 2005. Wild chimpanzees show population-level handedness for tool use. *Proc. Natl. Acad. Sci. United States Am.* 102, 12634–12638.

L pez Quintana, J.C., 2015. Proyecto de ampliaci  de la zona a explotar de la C.E. Cantera Zubiondo promovido por la empresa Canteras Zubiondo S.L.

Lorincz, E., Fabre-Thorpe, M., 1994. Effect of practice on paw preference in a reaching

task in cats. *Comptes Rendus l'Académie des Sci. - Ser. III- Sci. la Vie* 317, 1081–1088.

Loring, D.W., Meador, K.J., Lee, G. P., Murro, A.M., Smith, J.R., Flanigin, H.F., Gallagher, B.B., King, D.W., 1990. Cerebral language lateralization: evidence from intracarotid amobarbital testing. *Neuropsychologia* 28, 831–838.

Lozano, M., Bermúdez de Castro, J.M., Martínón-Torres, M., Sarmiento, S., 2004. Cutmarks on fossil human anterior teeth of the Sima de los Huesos site (Atapuerca, Spain). *J. Archaeol. Sci.* 31, 1127–1135.

Lozano, M., Mosquera, M., Bermúdez de Castro, J.M., Arsuaga, J.L., Carbonell, E., 2009. Right handedness of *Homo heidelbergensis* from Sima de los Huesos (Atapuerca, Spain) 500,000 years ago. *Evol. Hum. Behav.* 30, 369–376. doi:10.1016/j.evolhumbehav.2009.03.001

Luria, A.R., 1976. *Basic problems in neurolinguistics*. Mouton, The Hague.

MacNeilage, P.F., Rogers, L.J., Vallortigara, G., 2009. Origins of the Left & Right Brain. *Sci. Am.* 301, 60–67.

MacNeilage, P.F., Studdert-Kennedy, M.G., Lindblom, B., 1987. Primate handedness reconsidered. *Behav. Brain Sci.* 10, 247–303.

Nolte y Aramburu, E., 1963. Algunos de los nuevos yacimientos prehistóricos descubiertos en la provincia de Vizcaya y puesta al día del Catálogo general de los mismos con la inclusión de la fauna cavernícola y Bibliografía General. Grupo Espeleológico Vizcaíno de la Diputación de Vizcaya, Bilbao.

Mapp, A.P., Ono, H., Barbeito, R., 2003. What does the dominant eye dominate? A brief and somewhat contentious review. *Percept. Psychophys.* 65, 310–7. doi:10.3758/

BF03194802

Marchant, L.F., McGrew, W.C., 2013. Handedness is more than laterality: lessons from chimpanzees. *Ann. N. Y. Acad. Sci.* 1288, 1–8. doi:10.1111/nyas.12062

Marchant, L.F., McGrew, W.C., 1996. Laterality of limb function in wild chimpanzees of Gombe national park: Comprehensive study of spontaneous activities. *J. Hum. Evol.* 30, 427–443.

Marchant, L.F., McGrew, W.C., Eibl-Eibesfeldt, I., 1995. Is human handedness universal? Ethological analyses from three traditional cultures. *Ethology* 101, 239–258.

Marchant, L.F., Steklis, H.D., 1986. Hand preference in a captive island group of chimpanzees. *Am. J. Primatol.* 10, 301–313.

Marcos Muñoz, J.L., 1982. Carta Arqueológica de Vizcaya. Diputación Foral de Vizcaya, Bilbao.

Marcos Muñoz, J.L., Muñoz Salvatierra, M., 1984. Excavaciones en la cueva de Lacilla. *Munibe* 36, 55–58.

Marquet, J.-C., 1988. Paleoecologie, Paleoclimatologie et Chronologie de la Grotte Vaufray D'Après les Rongeurs, in: Rigaud, J.-P. (Ed.), *La Grotte Vaufray: Paléoenvironnements, Chronologie, Activités Humaines*. *Memoires de la Societe Prehistorique Française* 19, pp. 323–356.

Martín, I., Zubizarreta, A., 1990. Actuaciones arqueológicas en el municipio de Bilbao, 1989. *Cuad. Sección. Prehist. Arqueol.* 4, 157–195.

Martínez, I., Arsuaga, J.L., 2009. El origen del lenguaje: la evidencia paleontológica.

Munibe 60, 5–16.

Martínez, I., Arsuaga, J.L., Quam, R., Carretero, J.M., Gracia, A., L., R., 2008a. Human hyoid bones from the middle Pleistocene site of the Sima de los Huesos (Sierra de Atapuerca, Spain). *J. Hum. Evol.* 54, 118–124.

Martínez, I., Quam, R.M., Rosa, M., Jarabo, P., Lorenzo, C., Arsuaga, J.L., 2008b. Auditory capacities of human fossils: a new approach to the origin of speech, in: *Proceedings of the 2nd ASA-EAA Joint Conference Acoustics*. pp. 4177–4182.

Martínez, I., Quam, R., Arsuaga, J.L., Lorenzo, C., Gracia, A., Carretero, J., Rosa, M., Jarabo, P., 2009. Paleontological approaches to the evolution of language: the state of the art. *Anthropologie*. 113, 255–264.

Martínez, I., Rosa, M., Arsuaga, J.L., Jarabo, P., Quam, R., Lorenzo, C., Gracia, A., Carretero, J.M., Bermúdez de Castro, J.M., Carbonell, E., 2004. Auditory capacities in Middle Pleistocene humans from the Sierra de Atapuerca in Spain. *Proc. Natl. Acad. Sci. U. S. A.* 101, 9976–9981.

Maureille, B., 2002. La redécouverte du nouveau-né néandertalien Le Moustier 2. *Paléo* 14, 2–21.

Masataka, N., 1990. Handedness of capuchin monkeys. *Folia Primatol.* 55, 189–192.

Matoba, M., Masataka, N., Tanioka, Y., 1991. Cross-generational continuity of hand-use preferences in marmosets. *Behaviour* 117, 281–286.

Mazo, C., Rodanés, V., 1986. Corpus de útiles pulimentados de la comarca de Monzón (Huesca). *Inst. Estud. Altoaragoneses* 11, 1–141.

McGrew, W.C., Marchant, L.F., 1999. Laterality of hand use pays off in foraging success for wild chimpanzees. *Primates* 40, 509–513.

McGrew, W.C., Marchant, L.F., 1992. Chimpanzees, tools and termites: Hand preference or handedness? *Curr. Anthropol.* 33, 114–119.

McKeever, W.F., 1986. The influences of handedness, sex, familial sinistrality and androgyny on language laterality, verbal ability, and spatial ability. *Cortex* 22, 521–537.

McManus, I.C., 2009. The history and geography of human handedness, in: Sommer, I.E.C., Kahn, R.S. (Eds.), *Language Lateralization and Psychosis*. Cambridge University Press, Cambridge, pp. 37–57.

McManus, I.C., 1982. The distribution of skull asymmetry in man. *Ann. Hum. Biol.* 9, 167–170.

McManus, I.C., 1985. Handedness, language dominance and aphasia: A genetic model. *Psychol. Med. Monogr. Suppl.* 8, 1–40.

McManus, I.C., 1991. The inheritance of left-handedness, in: Bock, G.R., Marsh, J. (Eds.), *Biological Asymmetry and Handedness*. Wiley-VCH, Chichester, pp. 251–281.

McManus, I.C., Bryden, M.P., 1991. The genetics of handedness, cerebral dominance, and lateralization, in: Rapin, I., Segalowitz, S.J. (Eds.), *Handbook of Neuropsychology, Section 10: Developmental Neuropsychology*. Elsevier, Amsterdam, pp. 115–144.

McManus, I.C., Davison, A., Armour, J.A., 2013. Multilocus genetic models of handedness closely resemble single-locus models in explaining family data and are compatible with genome-wide association studies. *Ann. N. Y. Acad. Sci.* 1288, 48–58. doi:10.1111/nvas.12102



McManus, I.C., Porac, C., Bryden, M.P., Boucher, R., 1999. Eye-dominance, writing hand, and throwing hand. *Laterality* 4, 173–192.

Megirian, D., Weller, L., Martin, G.F., Watson, C.R., 1977. Aspects of laterality in the marsupial *Trichosorus vulpecula* (Brush-tailed possum). *Ann. N. Y. Acad. Sci.* 299, 197–212.

Mellars, P., Gibson, K., 1996. *Modelling the Early Human Mind Symbolism*. McDonald Institute for Archaeological Research, Cambridge (United Kingdom).

Mellars, P., Grün, R., 1991. A comparison of the electron spin resonance and thermoluminescence dating methods : the results of ESR dating at Le Moustier (France). *Cambridge Archaeol. J.* 1, 269–276.

Menon, R.S., Ogawa, S., Strupp, J.P., Ugurbil, K., 1997. Ocular dominance in human V1 demonstrated by functional magnetic resonance imaging. *J. Neurophysiol.* 77, 2780–2787.

Merrell, D.J., 1957. Dominance of eye and hand. *Hum. Biol.* 29, 314–328.

Miller, E., 1971. Handedness and the pattern of human ability. *Br. J. Psychol.* 103, 262–268.

Mills, L., 1925. Eyedness and handedness. *Am. J. Ophthalmol.* 8, 933–941.

Milner, A.D., 1969. Distribution of hand preferences in monkeys. *Neuropsychologia* 7, 375–377.

Mithen, S., 1996a. *The Prehistory of the Mind: A Search for the Origins of Art, Religion*

and Science. Pheonix paperback edition, Pheonix.

Mithen, S., 1996b. *The Prehistory of the Mind: A Search for the Origins of Art, Religion and Science*. Thames and Hudson.

Money, J., 1972. Studies on the function of sighting dominance. *J. Exp. Psychol.* 24, 454–464.

Mukhametov, L.M., 1987. Unihemispheric slow-wave sleep in the Amazonian dolphin, *Inia geoffrensis*. *Neurosci. Lett.* 79, 128–132.

Myers, R., Sperry, R.W., 1953. Interocular transfer of a visual from discrimination habit in cats after section of the corpus callosum and optic chiasm. *Anat. Rec.* 115, 351–352.

Myers, R.E., 1965. The neocortical commissures and interhemispheric transmission of information, in: Ettliger, G. (Ed.), *CIBA Foundation Study Group No. 20: Functions of the Corpus Callosum*. London, pp. 1–17.

Myers, R.E., 1962. Transmission of visual information within and between the hemispheres: a behavioural study, in: Mountcastle, V.B. (Ed.), *Interhemispheric Relations and Cerebral Dominance*. The Johns Hopkins University Press, Baltimore, pp. 51–74.

Myers, R.E., 1960. Failure of intermanual transfer in corpus callosum - sectioned chimpanzees. *Anat. Rec.* 136, 358.

Napier, J.R., 1962. The evolution of the hand. *Sci. Am.* 207, 56–62.

Narang, H.K., 1977. Right-left asymmetry of myelin development in epiretinal portion of rabbit optic nerve. *Nature* 266, 855–856.

Nedjar, T., Touari, M., Mesbah, M., Lellouch, J., Dellatolas, G., 1989. La préférence manuelle dans une population d'étudiants algériens francophones et comparaison avec la population française. *Annee. Psychol.* 89, 239–253.

Nicholls, H.R., 1961. In situ determination of the dynamic elastic constants of rock.

Nishida, W.A., Hiraiwa, M., 1982. Natural history of a tool-using behaviour by wild chimpanzees. *J. Hum. Evol.* 11, 73–99.

Nolte y Aramburu, E., 1963. Algunos de los nuevos yacimientos prehistóricos descubiertos en la provincia de Vizcaya y puesta al día del Catálogo general de los mismos con la inclusión de la fauna cavernícola y Bibliografía General. Grupo Espeleológico Vizcaíno de la Diputación de Vizcaya, Bilbao.

Nolte y Aramburu, E., 1985. *Miscelanea Arqueológica (VIII)*. *Kobie* 15, 233–244.

O'Malley, R.C., McGrew, W.C., 2006. Hand preferences in captive orangutans (*Pongo pygmaeus*). *Primates* 47, 279–283.

Ojemann, G.A., Mateer, C., 1979. Cortical and subcortical organization of human communication: evidence from stimulation studies, in: Steklis, H.D., Raleigh, M.J. (Eds.), *Neurobiology of Social Communication in Primates*. Academic Press, London.

Oldfield, R.C., 1971. The assessment and analysis of handedness: the Edinburgh Inventory. *Neuropsychologia* 9, 97–103.

Ollé, A., 2003. Variabilitat i patrons funcionals en els Sistemes Tècnics de Mode 2. Anàlisi de les deformacions d'us en els conjunts lítics del Riparo Esterno de Grotta Paglicci (Rignano Garganico, Foggia), 'Aridos (Arganda, Madrid) i Galería-TN (Sierra de Atapuerca, Bu. Universitat Rovira i Virgili.

Olson, D.A., Ellis, J.E., Nadler, R.D., 1990. Hand preferences in captive gorillas, orangutans and gibbons. *Am. J. Primatol.* 20, 83–94.

Ormazabal, A., Pastor, B., Urigoitia, T., 1994. Ensayo de estudio analítico del instrumental lítico pulimentado. Su aplicación al conjunto de superficie de Urrunaga (Álava). *Munibe* 46, 87–110.

Papadatou-Pastou, M., 2011. Handedness and language lateralization: Why are we right-handed and left-brained? *Hell. J. Psychol.* 8, 248–265.

Papousek, I., Schulter, G., 1999. Quantitative assessment of five behavioural laterality measures: Distributions of scores and intercorrelations among right-handers. *Laterality* 4, 345–362.

Parnell, R.J., 2001. Hand preference for food processing in wild western lowland gorillas (*Gorilla gorilla gorilla*). *J. Comp. Psychol.* 115, 365–375.

Patterson, L.W., Sollberger, J.B., 1986. Comments on Toth's Right-Handedness Study. *Lithic Technol.* 15, 109–111.

Pedersen, P.M., Jorgensen, H.S., Nakayama, H., Raaschou, H.O., Olsen, T.S., 1995. Aphasia in acute stroke: Incidence, determinants, and recovery. *Ann. Neurol.* 38, 659–666. doi:10.1002/ana.410380416

Pelcin, A., 1997. The effect of indenter type on flake attributes: evidence from a controlled experiment. *J. Archaeol. Sci.* 24, 613–621.

Pelegrin, J., 1995. Technologie lithique: le Châtelperronien de Roc-de-Combe (Lot) et de LaCôte (Dordogne), Cahiers du Quaternaire. Éditions du CNRS, Paris.

Pelegrin, J., 2000. Les techniques de débitage laminaire au Tardiglaciaire: critères de diagnose et quelques réflexions, in: B., V., Bodu, P., Christensen, M. (Eds.), L'Europe Centrale et Septentrionale Au Tardiglaciaire. Actes de La Table-Ronde Internationale de Nemours. Mémoires du Musée de Préhistoire de France, Nemours, pp. 73–86.

Pence, S., 2002. Paw preference in rats. *J. Basic Clin. Physiol. Pharmacol.* 13, 475–483.

Perelle, I.B., Ehrman, L., 1994. An international study of human handedness: The data. *Behav. Genet.* 24, 217–227.

Peters, H.H., Rogers, L.J., 2008. Limb use and preferences in wild orang-utans during feeding and locomotor behavior. *Am. J. Primatol.* 70, 261–270.

Petersen, M.R., Beecher, M.D., Zoloth, S.R., Moody, D.B., Stebbins, W.C., 1978. Neural lateralization of species-specific vocalizations by Japanese macaques (*Macaca fuscata*). *Science* (80-. ). 202, 324–327.

Petrova, L.P., Markovskikh, E.P., 1986. Bilateral imprinting in the chicks of precocial birds in response to monocular presentation of an object. *Zh Vyss. Nerv Deiat Im I P Pavlov.* 36, 324–327.

Peyrony, D., 1921. Les mousteriens inhumèrent-ils leurs morts? Ribes et Cie, Périgueux.

Peyrony, D., 1930. Le Moustier, ses gisements, ses industries, ses couches géologiques. *Rev. Anthropologique* 40, 155–176.

Plato, C.C., Fox, K.M., Garruto, R.M., 1984. Measures of lateral functional dominance: Hand dominance. *Hum. Biol.* 56, 259–275.

Plotkin, H.C., 1982. Evolutionary epistemology and evolutionary theory, in: Plotkin (Ed.), *Learning, Development and Culture: Essays in Evolutionary Epistemology*. Wiley, Chichester.

Pobiner, B.L., 1999. The use of stone tools to determine handedness in hominids. *Curr. Anthropol.* 40, 90–92.

Pointer, J.S., 2001. Sighting dominance, handedness, and visual acuity preference: Three mutually exclusive modalities? *Ophthalmic Physiol. Opt.* 21, 117–126.

Pollet, T. V., Stulp, G., Groothuis, T.G.G., 2013. Born to win? Testing the fighting hypothesis in realistic fights: Left-handedness in the ultimate fighting championship. *Anim. Behav.* 86, 839–843. doi:10.1016/j.anbehav.2013.07.026

Porac, C., Coren, S., 1981. *Lateral preferences and human behavior*. Springer-Verlag, New York.

Porac, C., Coren, S., 1976. The dominant eye. *Psychol. Bull.* 83, 880–897.

Porac, C., Coren, S., 1975. Is eye dominance a part of generalized laterality? *Percept. Mot. Skills* 40, 763–769.

Porac, C., Whitford, F.W., Coren, S., 1976. The relationship between eye dominance and monocular acuity: An additional consideration. *Am. J. Optom. Physiol. Opt.* 53, 803–806.

Porta, J.B., 1593. *De refractione optics parte: Libri novem*. Carlinum & Pacem, Naples.

Portal, J.M., Romano, P.E., 1998. Ocular sighting dominance: a review and a study of athletic proficiency and eye-hand dominance in a collegiate baseball team. *Binocul. Vis. Strabism Q.* 13, 125–132.

Poyser, F., Caldwell, C., Cobb, M., 2006. Dog paw preference shows lability and sex differences. *Behav. Processes* 73, 216–221.

Price, C.J., 2000. The anatomy of language: contributions from functional neuroimaging. *J. Anat.* 197, 335–359.

Provins, K.A., 1997a. Handedness and speech: A critical reappraisal of the role of genetic and environmental factors in the cerebral lateralization of function. *Psychol. Rev.* 104, 554–571.

Provins, K.A., 1997b. The specificity of motor skill and manual asymmetry: a review of the evidence and its implications. *J. Mot. Behaviour* 29, 183–192.

Pujol, J., Deus, J., Losilla, J.M., Capdevila, A., 1999. Cerebral lateralization of language in normal left-handed people studied by functional MRI. *Neurology* 52, 1038–1043.

Quinan, C., 1930. Principal sinistral types. *Arch. Neurol. Psychiatry* 24.

Quinan, C., 1922. A study of sinistrality and muscle coordination in musicians, iron-workers and others. *Arch. Neurol. Psychiatry* 7, 352–360.

Ramaley, F., 1913. The inheritance of left-handedness. *Am. Nat.* 47, 730–739.

Rasmussen, T., Milner, B., 1977. The role of early left-brain injury in determining lateralization of cerebral speech functions. *Ann. N. Y. Acad. Sci.* 299, 355–369.

Raymond, M., Pontier, D., 2004. Is there geographical variation in human handedness? *Laterality* 9, 35–51.

Raymond, M., Pontier, D., Dufour, A.B., Moller, A.P., 1996. Frequency-dependent maintenance of left handedness in humans. *Proc. R. Soc. London* 263, 1627–1633.

Regalado Bueno, E., 2011. Prospección y estudio de patrimonio arqueológico en la comarca de Uribe Kosta. *Isturitz* 12, 115–134.

Rein, R., Bril, B., Nonaka, T., 2013. Coordination Strategies Used in Stone Knapping. *Am. J. Phys. Anthropol.* 150, 539–550.

Renfrew, C., 2007. *Prehistory: The Making of the Human Mind*. Weidenfeld & Nicolson.

Renfrew, C., Zubrow, E.B.W., 1993. *The Ancient Mind: Elements of Cognitive Archeology*. Cambridge University Press, Cambridge (United Kingdom).

Rife, D.C., 1950. An application of gene frequency analysis to the interpretation of data from twins. *Hum. Biol.* 22, 136–145.

Rigaud, J.-P., 1988a. La grotte Vaufréy a Cenac et Saint-Julien (Dordogne): Paléoenvironnements, Chronologie et Activités Humaines. *Memoires de la Societe Prehistorique Française* 19.

Rigaud, J.-P., 1988b. Analyse Typologique des Industries de la Grotte Vaufréy, in: Rigaud, J.-P. (Ed.), *La Grotte Vaufréy: Paléoenvironnements, Chronologie, Activités Humaines*. *Memoires de la Societe Prehistorique Française* 19, pp. 389–439.

Ríos Garaizar, J., González Urquijo, J.E., Ibáñez Estévez, J.J., 2003. La excavación en Axlor. Las formas de vida de los últimos neandertales. *Boletín la S.E.D.E.C.K.* 5, 62–63.

Roesler, F.C., 1956. Brittle Fractures near Equilibrium. *Proc. Phys. Soc.* 69, 981–992.



Roffman, I., Savage-Rumbaugh, S., Rubert-Pugh, E., Ronen, A., Nevo, E., 2012. Stone tool production and utilization by bonobo-chimpanzees (*Pan paniscus*). PNAS 109, 14500–14503.

Rogers, L.J., 2009. Hand and paw preferences in relation to the lateralized brain. Philos. Trans. R. Soc. B Biol. Sci. 364, 943–954. doi:10.1098/rstb.2008.0225

Rogers, L.J., 1993. The evolution and development of brain asymmetry, and its relevance to language, tool use and consciousness. Inaugural public lecture. University of New England-Armidale, New South Wales.

Rogers, L.J., 1982. Light experience and asymmetry of brain function in chickens. Nature 297, 223–225.

Rogers, L.J., Kaplan, G., 1996. Hand preferences and other lateral biases in rehabilitated orang-utans (*Pongo pygmaeus pygmaeus*). Anim. Behav. 51, 13–25.

Rogers, L.J., Vallortigara, G., Andrew, R.J., 2013. Divided brains: The biology and behaviour of brain asymmetries. Cambridge University Press, Cambridge.

Rombouts, S.A., Barkhof, F., Sprenger, M., Valk, J., Scheltens, P., 1996. The functional basis of ocular dominance: Functional MRI (fMRI) finding. Neurosci. Lett. 221, 1–4.

Rostain, S., 1990. Etude d'une chaîne opératoire: Les haches en pierre polie D'amazone. Arq. do Mus. Hist. Nat. da UFMG 11, 11–240.

Rothe, H., 1973. Handedness in the common marmoset (*Callithrix jacchus*). Am. J. Phys. Anthropol. 38, 561–566.

Roux, V., Bril, B., Dietrich, G., 2011. Skills and learning difficulties involved in stone knapping: the case of stone-bead knapping in Khambhat, India. *World Archaeol.* 27, 63–87.

Rugg, G., Mullane, M., 2011. Inferring handedness from lithic evidence. *Laterality* 6, 247–259. doi:10.1080/713754411

Sainburg, R., 2002. Evidence for a dynamic-dominance hypothesis of handedness. *Exp. Brain Res.* 142, 241–258. doi:10.1007/s00221-001-0913-8

Sainburg, R.L., Kalakanis, D., 2000. Differences in control of limb dynamics during dominant and nondominant arm reaching. *J. Neurophysiol.* 83, 2661–2675.

Sánchez, A., Calvo, A., Prieto, A., Sánchez-Dehesa, S., Abrunhosa, A., Fernández, A.Á., De Resende Machado, J., Dominguez-Ballesteros, E., Perales, U., 2015. Mesa Redonda 4: El estudio de la industria lítica en el siglo XXI. Preguntas pasadas, inercias heredadas, visiones renovadas, in: *Arqueologías Sociales. Arqueología En Sociedad*. Vitoria-Gasteiz, pp. 386–414.

Sanford, C., Guin, K., Ward, J.P.P., Stanford, C., Guin, K., Ward, J.P.P., 1984. Posture and Laterality in the Bushbaby (*Galago senegalensis*). *Brain Behav. Evol.* 25, 217–224.

Savage-Rumbaugh, S., McDonald, K., Sevcik, R.A., Hopkins, W.D., Rubert, E., 1986. Spontaneous symbol acquisition and communicative use by pygmy chimpanzees (*Pan paniscus*). *J. Exp. Psychol.* 115, 211–235.

Schaeffel, F., Howland, H.C., Frakas, L., 1986. Natural accommodation in the growing chicken. *Vision Res.* 26, 1977–1993.

Scheumann, M., Joly-Radko, M., Leliveld, L., Zimmermann, E., 2011. Does body pos-

ture influence hand preference in an ancestral primate model? *BMC Evol. Biol.* 11, 52. doi:10.1186/1471-2148-11-52

Schindler, D.L., Hatch, J.W., Hay, C.A., Bradt, R.C., 1982. Aboriginal Thermal Alteration of a Central Pennsylvanian Jasper: Analytical and Behavioral Implications. *Am. Antiq.* 47, 526–544.

Schoen, Z.J., Scofield, C.F., 1935. A study of the relative neuromuscular efficiency of the dominant and non-dominant eye in binocular vision. *J. Gen. Psychol.* 11, 156–181.

Semenov, S.A., 1964. Prehistoric technology. Barnes & Noble, London.

Shafer, D.D., 1997. Hand preferences behaviors shared by two groups of captive bonobos. *Primates* 38, 303–313.

Smith, M., 1979. Behaviour of the koala, *Phascolarctos cinereus* (Goldfuss), in captivity. Non-social behaviour. *Aust. Wildl. Res.* 6, 117–128.

Snyder, A.M., Snyder, M.A., 1928. Eye preference tendencies. *J. Educ. Psychol.* 19, 431–433.

Soressi, M., 1999. Variabilité technologique au Moustérien. Analyse comparée du débitage Levallois MTA A du Moustier (Dordogne, France). *Paléo* 11, 111–134.

Sperry, R.W., 1958. Corpus callosum and interhemispheric transfer in the monkey (*Macaca Mulatta*). *Anat. Rec.* 131, 297.

Sperry, R.W., 1974. Lateral specialization in the surgically separated hemispheres, in: Schmitt, F., Worden, F. (Eds.), *Third Neurosciences Study Program*. MIT Press, Cambridge, pp. 5–19.

Sperry, R.W., Stamm, J.S., Miner, N., 1956. Relearning tests for interocular transfer following division of optic chiasma and corpus callosum in cats. *J. Comp. Physiol. Psychol.* 49, 529–533.

Stafne, G.M., 2004. Predominance of clockwise swimming during rest in southern hemisphere dolphins. *Physiol. Behav.* 82, 919–926.

Stamm, J.S., Sperry, R.W., 1957. Functions of corpus callosum in contralateral transfer of somesthetic discrimination in cats. *J. Comp. Physiol. Psychol.* 50, 138–143.

Steele, J., Uomini, N.T., 2005. Humans, tools and handedness, in: Roux, V., Bril, B. (Eds.), *Stone Knapping: The Necessary Conditions for a Uniquely Hominin Behaviour*. McDonald Institute for Archaeological Research, Cambridge, pp. 217–239.

Steenhuis, R.E., Bryden, M.P., 1989. Different dimensions of hand preference that relate to skilled and unskilled activities. *Cortex* 25, 289–304.

Stellar, E., 1960. The marmoset as a laboratory animal: Maintenance, general observations of behavior, and simple learning. *J. Comp. Physiol. Psychol.* 53, 1–10.

Stochl, J., 2012. *Five Essays on Laterality*. LAP LAMBERT Academic Publishing GmbH & Co. KG, Saarbrücken.

Stoodley, C.J., 2012. The cerebellum and cognition: Evidence from functional imaging studies. *Cerebellum* 11, 352–365.

Stout, D., 2002. Skill and Cognition in Stone Tool Production: An Ethnographic Case Study from Irian Jaya. *Curr. Anthropol.* 43, 693–722.

Stout, D., Toth, N., Schick, K., Stout, J., Hutchins, G., 2000. Stone tool-making and brain activation: Positron Emission Tomography (PET) studies. *J. Archaeol. Sci.* 27, 1215–1223. doi:10.1006/jasc.2000.0595

Tan, U., Caliskan, S., 1987. Allometry and asymmetry in the dog brain: The right hemisphere is heavier regardless of paw preference. *Int. J. Neurosci.* 35, 189–194.

Tan, U., Yaprak, M., Kutlu, N., 1990. Paw preference in cats: Distribution and sex differences. *Int. J. Neurosci.* 50, 195–208.

Texier, J.-P., 2009. Histoire géologique de sites préhistoriques classiques du Périgord : une vision actualisée. La Micoque, la grotte Vaufray, le Pech de l'Azé I et II, La Ferrassie, l'abri Castanet, le Flageolet, Laugerie Haute. Éditions du Comité des travaux historiques et scientifiques, Paris.

Thornton, C., 2012. Renewing the link between cognitive archeology and cognitive science. *J. Archaeol. Sci.* 39, 2036–2041. doi:10.1016/j.jas.2012.01.037

Tobias, P.V., 1983. Recent advances in the evolution of the hominids with especial references to brain and speech. *Pontif. Acad. Sci. Scr. Varia* 50, 85–140.

Toga, A.W., Thompson, P.M., 2003. Mapping brain asymmetry. *Nat. Rev. Neurosci.* 4, 37–48. doi:10.1038/nrn1009

Tokuda, K., 1969. On the handedness of Japanese monkeys. *Primates* 10, 41–46.

Toth, N., 1985. Archaeological evidence for preferential right-handedness in the lower and middle Pleistocene, and its possible implications. *J. Hum. Evol.* doi:10.1016/S0047-2484(85)80087-7

Toth, N., Clark, D., Ligabue, G., 1992. The Last Stone Ax- Makers. *Sci. Am.* 267, 88–93.

Trankell, A., 1955. Aspects of genetics in psychology. *Am. J. Hum. Genet.* 7, 264–276.

Trinkaus, E., Churchill, S.E., Ruff, C.B., 1994. Postcranial robusticity in *Homo II*: humeral Bilateral Asymmetry and Bone Plasticity. *Am. J. Phys. Anthropol.* 93, 1–34.

Turq, A., 2000. Les bases stratigraphiques régionales. *Paléo supplément*, 45–74.

Turq, A., Maureille, B., 2005. Excavations at the Le Moustier sites and their importance in French archaeology, in: Ullrich, H. (Ed.), *The Neanderthal Adolescent Le Moustier 1 - New Aspects, New Results*. Museum für Vor- und Frühgeschichte, Berlin, pp. 21–31.

Uomini, N.T., 2011. Handedness in Neanderthals, in: Conard, N.J., Richter, J. (Eds.), *Neanderthal Lifeways, Subsistence and Technology: One Hundred Fifty Year of Neanderthal Study*. Springer, London, pp. 139–154. doi:10.1007/978-94-007-0415-2

Valdés, L.G., 1981. Informe sobre talleres de útiles pulimentados en la comarca de L'Alt Urgell (I. Peramola). *Pyrenae* 17-18, 83–102.

Valladas, H., Geneste, J.M., Joron, J.L., Chadelle, J.P., 1986. Thermoluminescence dating of Le Moustier (Dordogne, France). *Nature* 322, 452–454. doi:10.1038/322452a0

Vandermeersch, B., 1971. *Catalogue of fossil Hominids, part II: Europe*. Trustees of the British Museum, London.

Van Wagenen, W.P., Herren, R.Y., 1940. Surgical division of commissural pathways in the corpus callosum: relation to spread of an epileptic attack. *Arch. Neurol. Psychiatry* 44, 740.

Vargha-Khadem, F., O’Gorman, A.M., Watters, G. V., 1985. Aphasia and handedness in relation to hemispheric side, age at injury and severity of cerebral lesion during childhood. *Brain* 108, 677–696.

Vegas, J.I., 1978. Yacimiento postpaleolítico de la Llosa. Leciñana de la Oca, Alava. *Estud. Arqueol. Alavesa* 9, 46–63.

Vegas, J.I., 1981. Yacimiento al aire libre de la finca Maroto (Cucho). *Estud. Arqueol. Alavesa* 10, 177.

Ventura, R.L., 2003. El síndrome de desconexión interhemisférica cerebral. *Rev. Psiquiatr. y salud Ment. Hermilio Vald.* 4, 29–42.

Veres, I., 1968. Electronmicroscopical investigations on bull sperm: The movement of the spermatozoa, their swimming stability and the double asymmetry of material dispersion in the head. *Mikroskopie* 22, 269–273.

Videan, E.N., McGrew, W.C., 2002. Bipedality in chimpanzee (*Pan Troglodytes*) and bonobo (*Pan paniscus*): Testing hypotheses on the evolution of bipedality. *Am. J. Phys. Anthropol.* 118, 184–190.

Vleeschouwer, K. De, Van Elsacker, L., Verheyem, R.F., 1995. Effect of posture on hand preferences during experimental food reaching in bonobos. *J. Comp. Psychol.* 109, 203–207.

Wade, N.J., 1998. Early studies of eye dominances. *Laterality* 3, 97–108.

Walls, G.L., 1951. A theory of ocular dominance. *Arch. Ophthalmol.* 45, 387–412.

Washburn, M.F., Faison, C., Scott, R., 1934. A comparison between the Miles A-B-C method and retinal rivalry as test of ocular dominance. *Am. J. Psychol.* 46, 633–636.

Wernicke, C., 1874. *Der aphasische symptom-complex*. Max Cohn and Weigert, Breslau.

Westergaard, G.C., Kuhn, H.E., Suomi, S.J., 1998. Bipedal posture and hand preference in humans and other primates. *J. Comp. Psychol.* 112, 55–64.

Westergaard, G.C., Lussier, I.D., 1999. Left-handedness and longevity in primates. *Int. J. Neurosci.* 99, 79–87.

White, M.J., 1969. Laterality differences in perception: A review. *Psychol. Bull.* 72, 387–405.

Williams, E.M., Gordon, A. D., R.B.G., 2010. Upper Limb Kinematics and the Role of the Wrist during Stone Tool Production. *Am. J. Phys. Anthropol.* 143, 134–154.

Wilson, P.T., Jones, H.E., 1932. Left-handedness in twins. *Genetics* 17, 560–571.

Windes, S., 1950. Physical properties of mine rocks.

Witelson, S.F., Kigar, D.L., 1992. Sylvian fissure morphology and asymmetry in men and women: bilateral differences in relation to handedness. *J. Comp. Neurol.* 323, 326–340.

Wittenborn, J.R., 1946. Correlates of handedness among college freshmen. *J. Educ. Psychol.* 37, 161–170.

Woods, R.P., Dodrill, C.B., Ojemann, G.A., 1988. Brain injury, handedness, and speech lateralization in a series of amobarbital studies. *Ann. Neurol.* 23, 510–518.



Wynn, T., 1985. Piaget, stone tools and the evolution of human intelligence. *World Archaeol.* 17, 32–43.

Zapata, L., 1995. La excavación del depósito sepulcral calcolítico de la cueva Pico Ramos (Muskiz, Bizkaia) La industria ósea y los elementos de adorno. *Munibe* 47, 35–90.

Zappia, J. V., Rogers, L.J., 1983. Light experience during development affects asymmetry of forebrain function in chickens. *Brain Res.* 313, 93–106.

Zhao, D., Wang, Y., Wei, X., 2016. Hand preference during bimanual coordinated task in northern pig-tailed macaques *Macaca leonina*. *Curr. Zool.* 1–16.

Zilles, K., Dabringhaus, A., Geyer, S., Amunts, K., Qü, M., Schleicher, A., Gilissen, E., Schlaug, G., Steinmetz, H., 1996. Structural asymmetries in the human forebrain and the forebrain of non-human primates and rats. *Neurosci. Biobehav. Rev.* 20, 593–605.

Zubizarreta, A., 1995. La estación megalítica de Artxanda (Bilbao, Bizkaia). Excavación del dolmen Hirimugarrieta 2. *Cuad. Sección. Prehist. Arqueol.* 6, 259–276.

Zverev, Y.P., 2006. Cultural and environmental pressure against left-hand preference in urban and semi-urban Malawi. *Brain Cogn.* 60, 295–303. doi:10.1016/j.bandc.2005.07.008



# **Anexo I**



Annex I:

Annex I shows in detail the experimental and archaeological polished axes. All measurements of length, width and thickness, as well as the amplitudes are taken in millimeters.

In the experimental axes the minutes of polishing for each one of the phases that have been photographed have been detailed. In each phase all the faces of the experimental axes have been photographed and an outline of each one of them has been drawn. The measures for this moment of polishing have also been detailed.

In the archeological axes the frontal face (face C) has been photographed and a schematic of that face has been made, representing the cut. The measures of each archaeological axe and its type of cut have also been detailed.



# Hachas experimentales





**E0**

Longitud: 122 mm  
Anchura: 76 mm  
Espesor máximo: 53 mm  
Anchura del corte: 56 mm  
Materia prima: Ofita

**Fase final**  
(200 minutos)

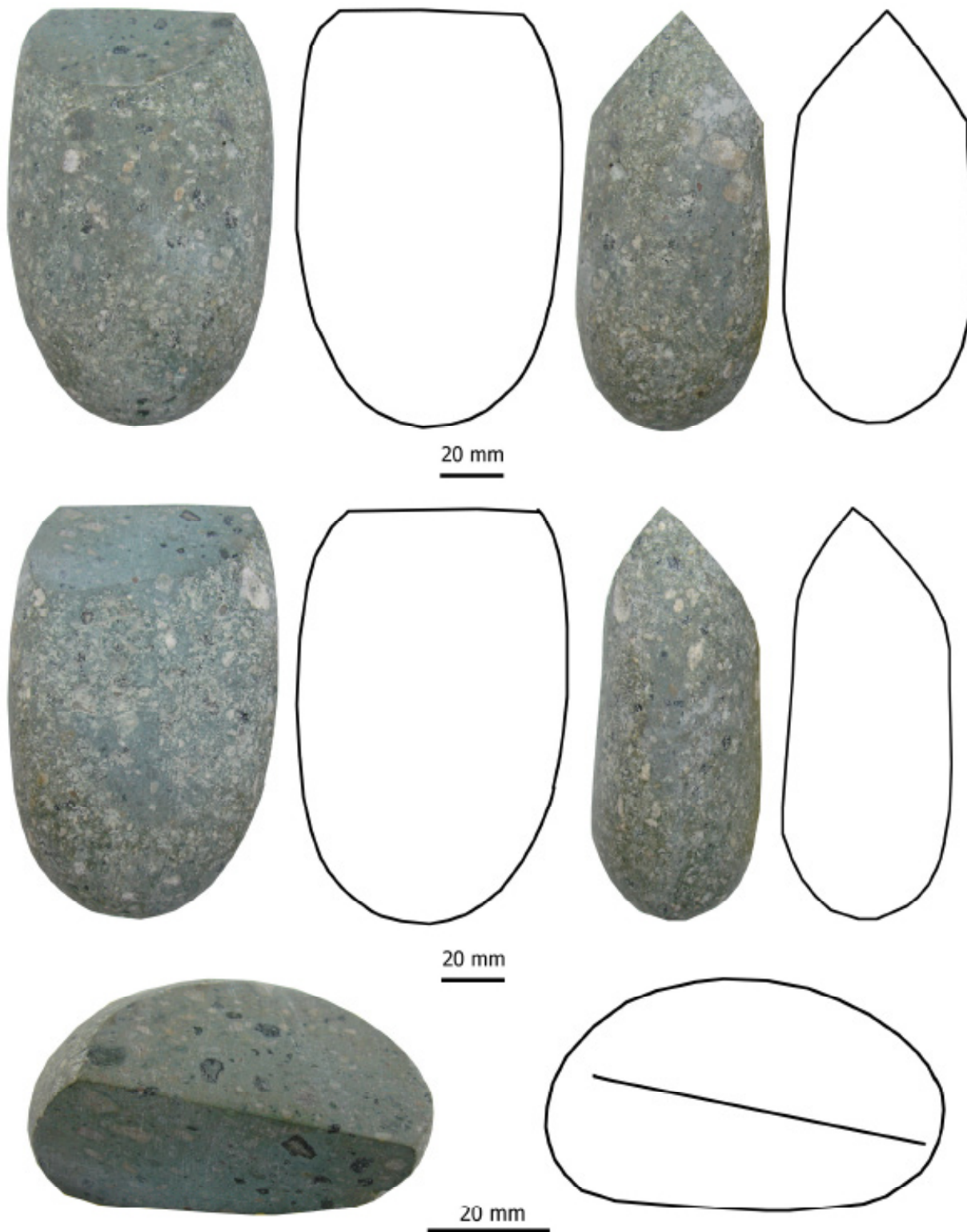

**E1**

Longitud: 90 mm  
Anchura: 62 mm  
Espesor máximo: 34 mm  
Anchura del corte:  
Materia prima: Ofita

**Fase 0**

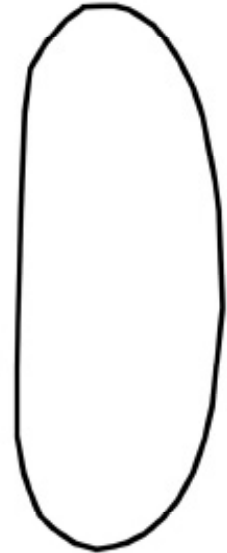
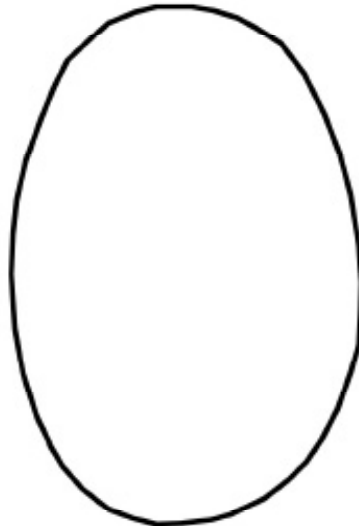

20 mm

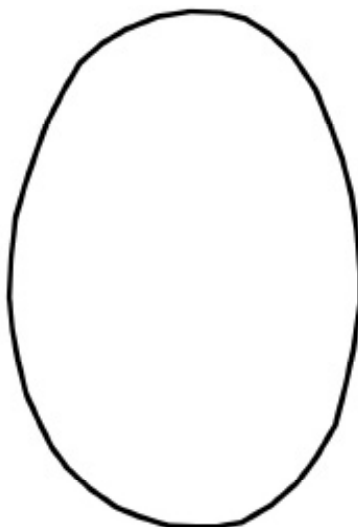

20 mm



20 mm

**E1**

Longitud: 90 mm  
Anchura: 62 mm  
Espesor máximo: 34 mm  
Anchura del corte: --  
Materia prima: Ofita

**Fase 1**  
(20 minutos)

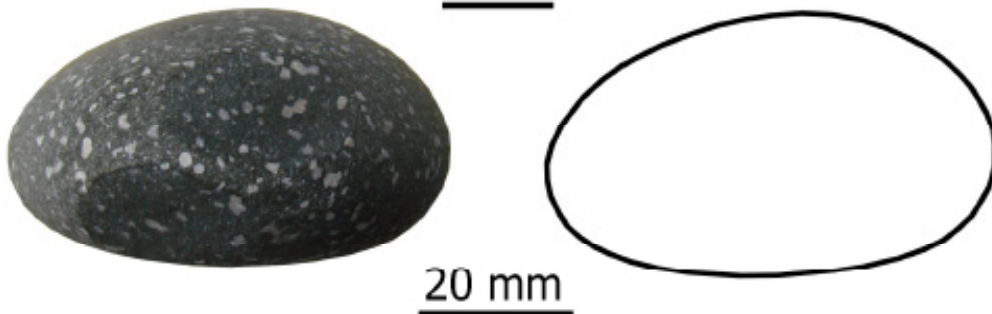
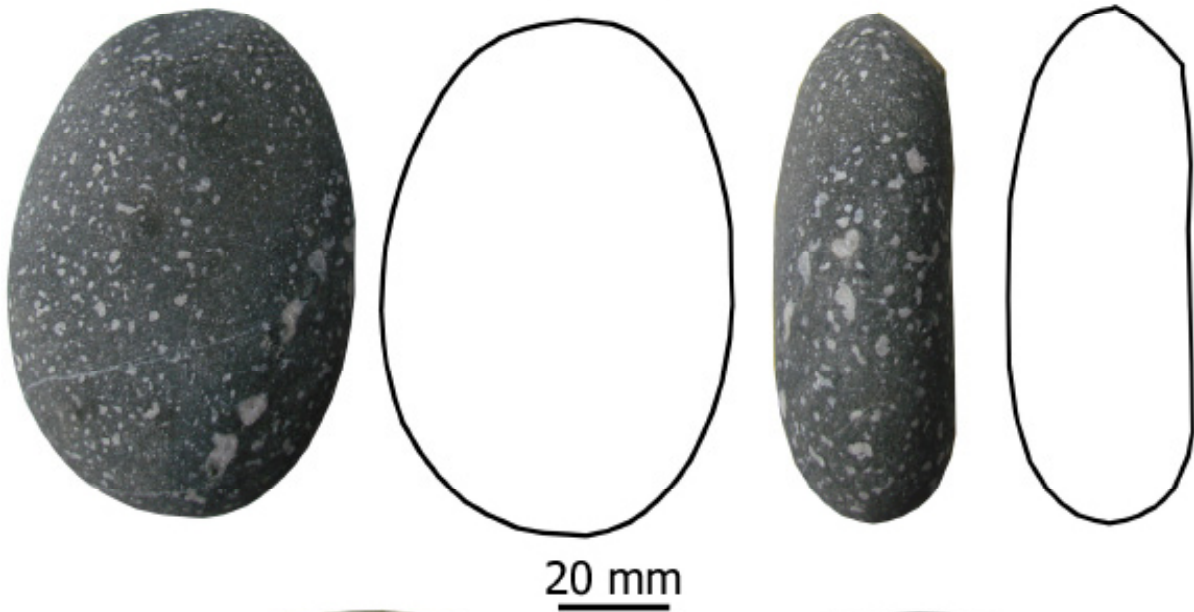
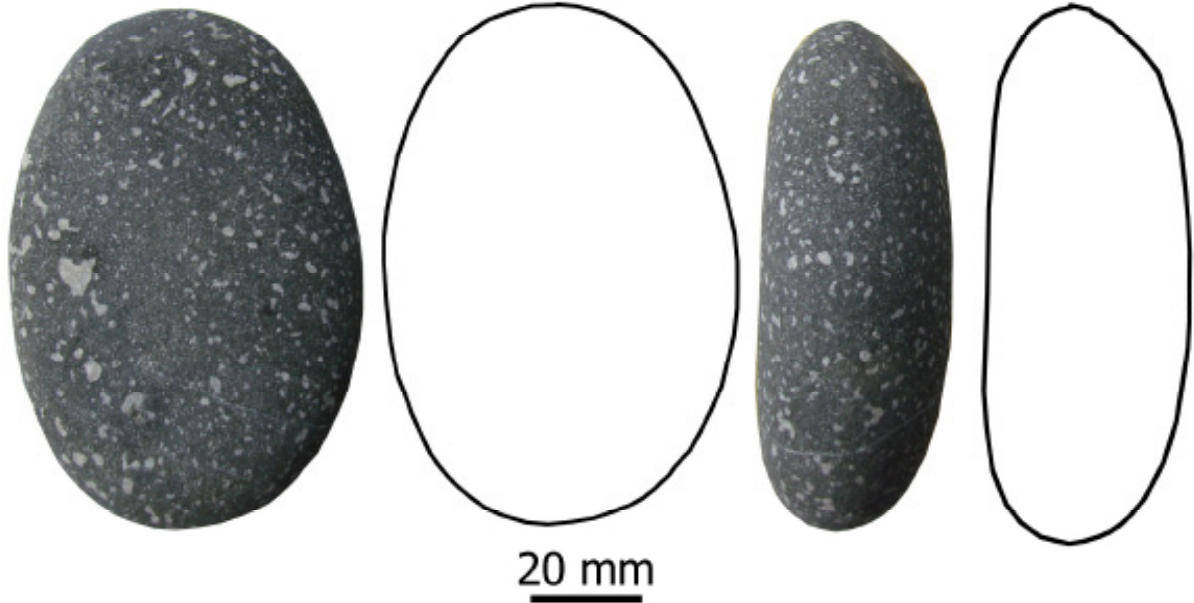



**E1**

Longitud: 90 mm  
Anchura: 62 mm  
Espesor máximo: 34 mm  
Anchura del corte: 5 mm  
Materia prima: Ofita

**Fase 2**  
(30 minutos)

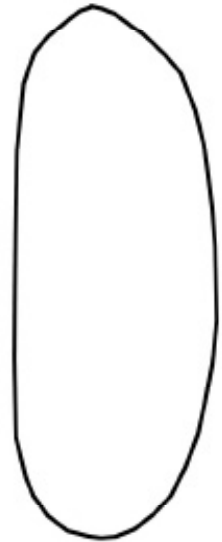
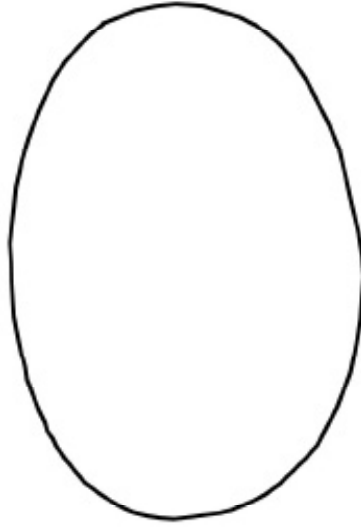

20 mm

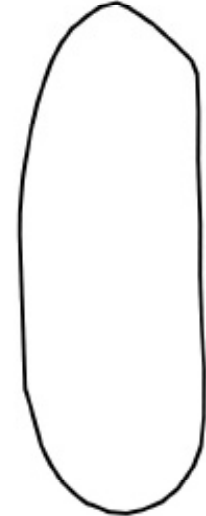
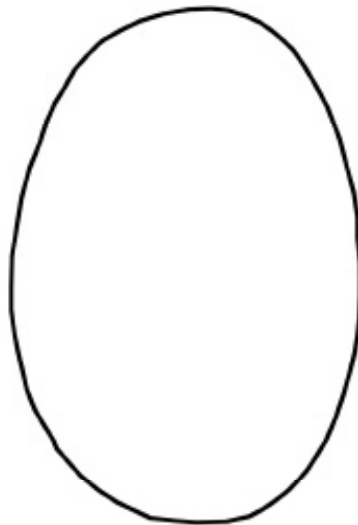

20 mm



20 mm

**E1**

Longitud: 90 mm  
Anchura: 62 mm  
Espesor máximo: 34 mm  
Anchura del corte: 20 mm  
Materia prima: Ofita

**Fase 3**  
(50 minutos)

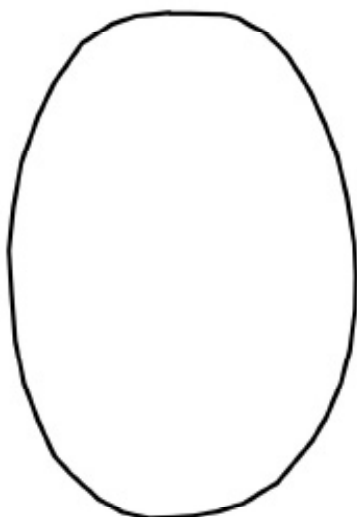

20 mm

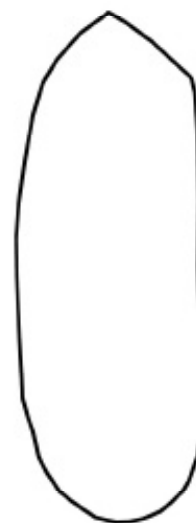
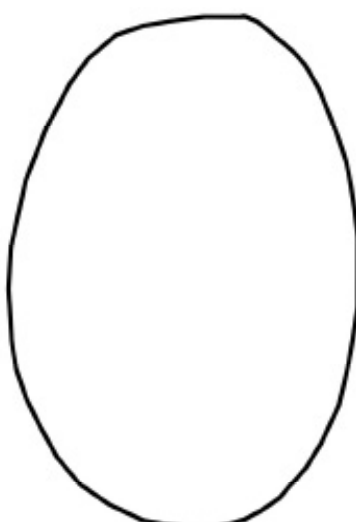

20 mm



20 mm

**E1**

Longitud: 88 mm  
Anchura: 62 mm  
Espesor máximo: 34 mm  
Anchura del corte: 25 mm  
Materia prima: Ofita

**Fase 4**  
(80 minutos)

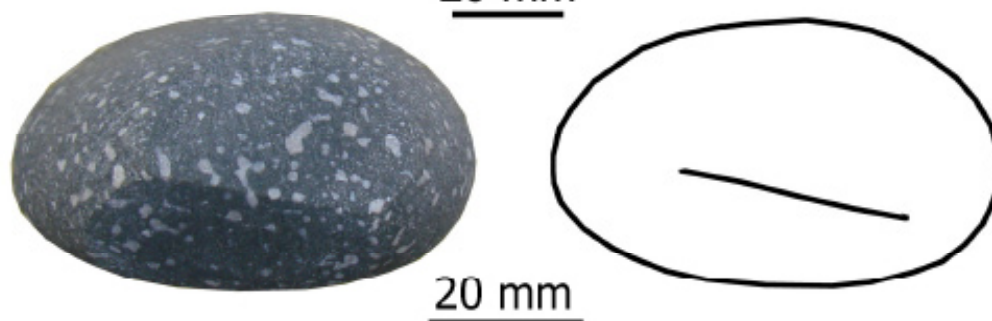



**E1**

Longitud: 86 mm  
Anchura: 62 mm  
Espesor máximo: 34 mm  
Anchura del corte: 29 mm  
Materia prima: Ofita

**Fase 5**  
(110 minutos)

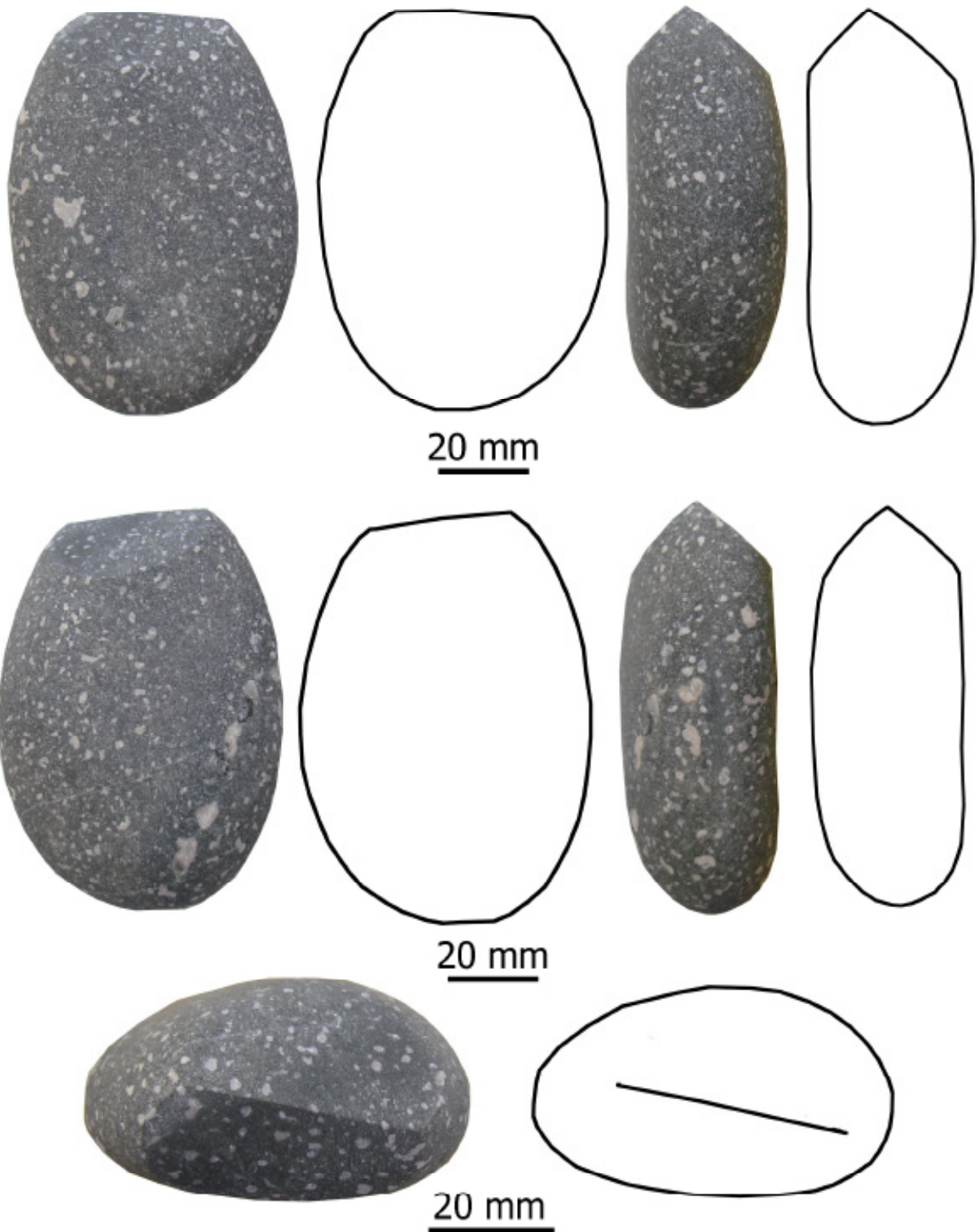

**E1**

Longitud: 85 mm  
Anchura: 62 mm  
Espesor máximo: 34 mm  
Anchura del corte: 33 mm  
Materia prima: Ofita

**Fase 6**  
(140 minutos)

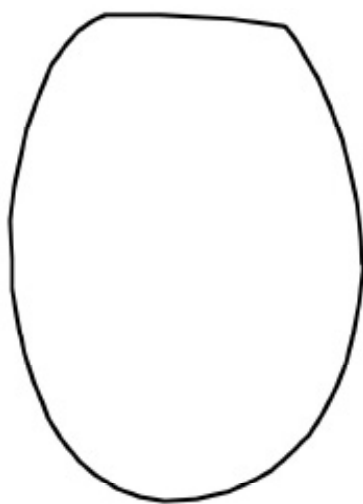

20 mm

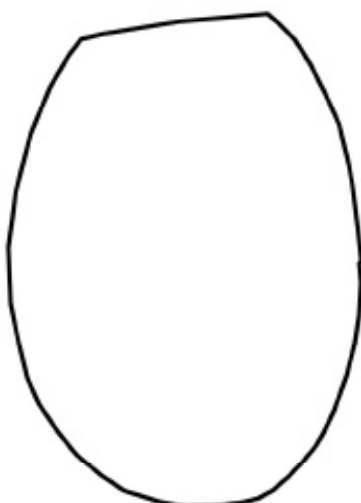

20 mm

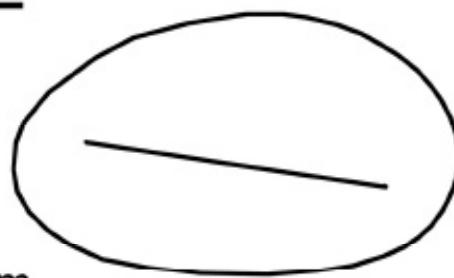

20 mm



**E1**

Longitud: 84 mm  
Anchura: 62 mm  
Espesor máximo: 34 mm  
Anchura del corte: 36 mm  
Materia prima: Ofita

**Fase 6**  
(170 minutos)

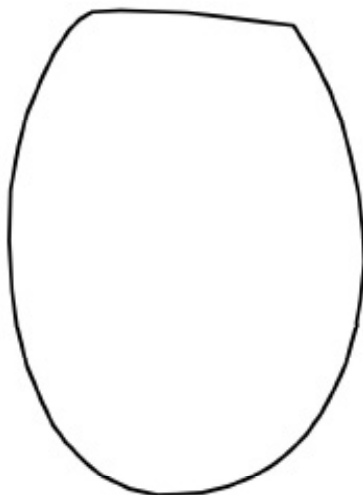

20 mm

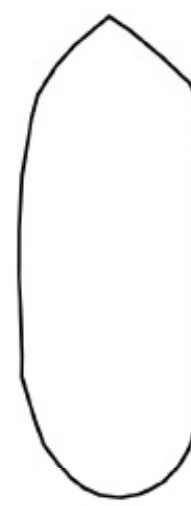
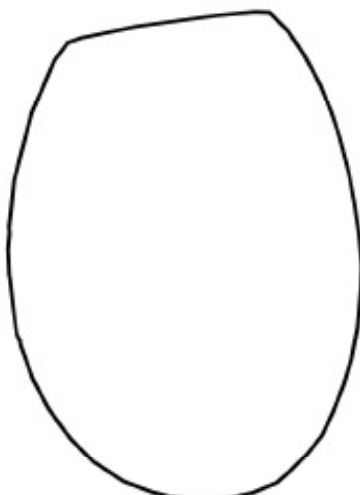

20 mm



20 mm

**E1**

Longitud: 84 mm  
Anchura: 62 mm  
Espesor máximo: 34 mm  
Anchura del corte: 37 mm  
Materia prima: Ofita

**Fase final**  
(200 minutos)

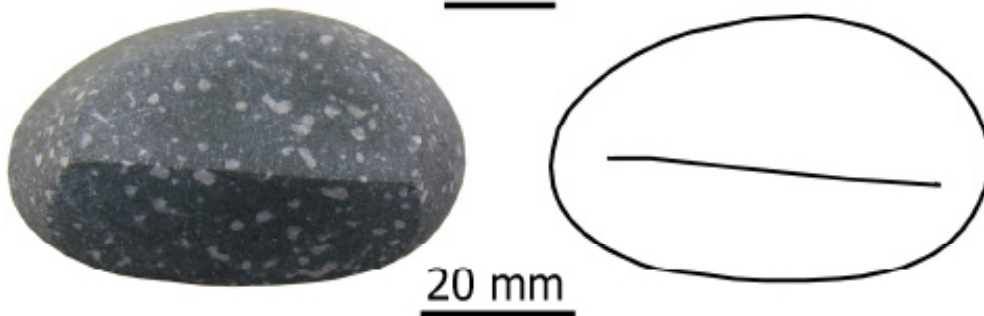
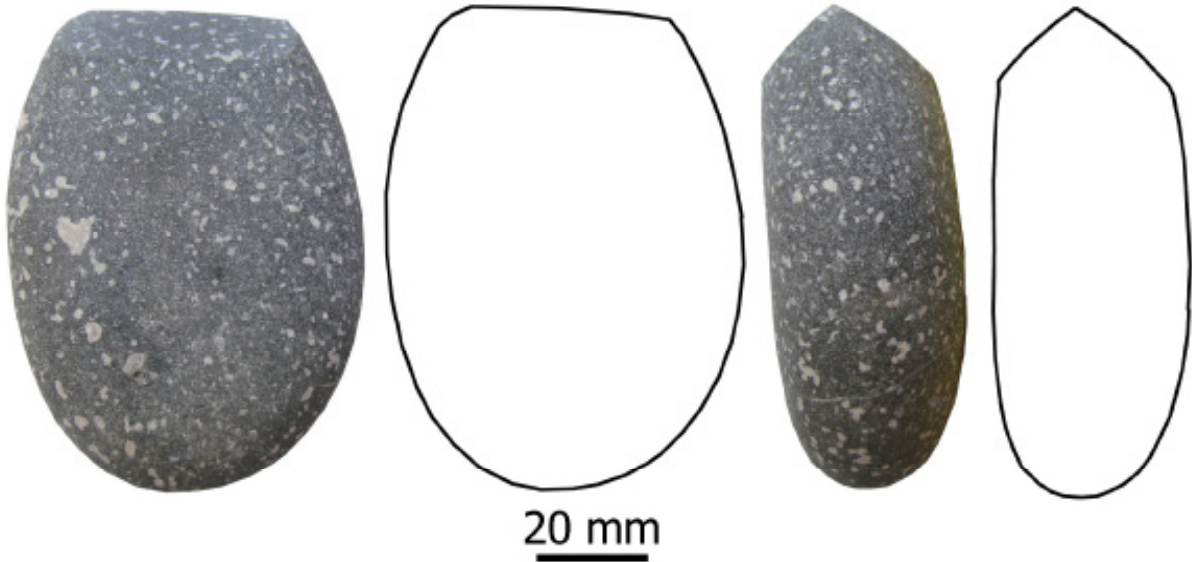

# Ed3

Longitud: 142 mm  
Anchura: 60 mm  
Espesor máximo: 24 mm  
Anchura del corte: 37 mm  
Materia prima: Ofita

Fase final  
(200 minutos)



20 mm

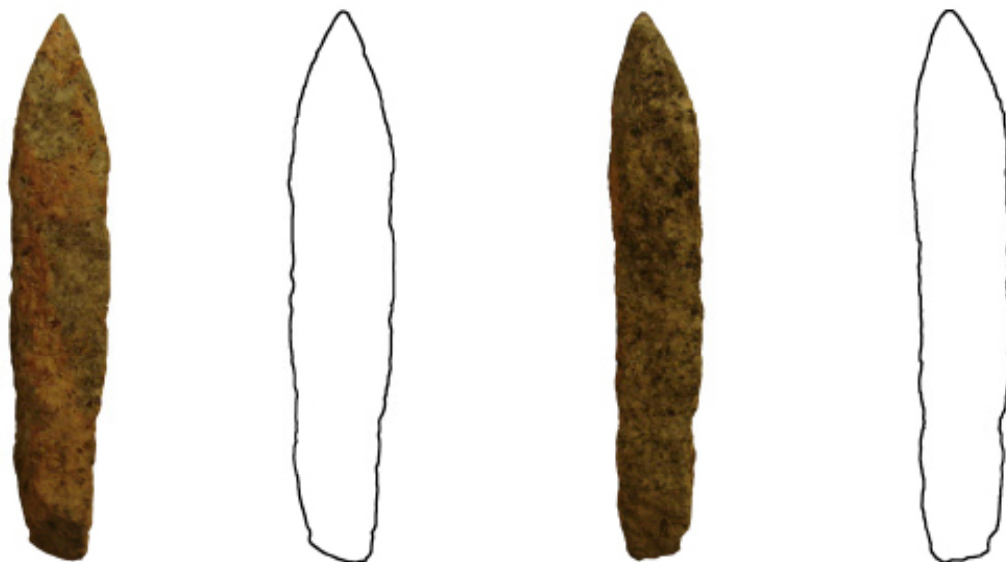

20 mm



60 mm

**As1**

**As2**

Longitud: 99 mm  
Anchura: 76 mm  
Espesor máximo: 46 mm  
Anchura del corte: 29 mm / 20 mm  
Materia prima: Basalto

**Fase final**  
(200 minutos)

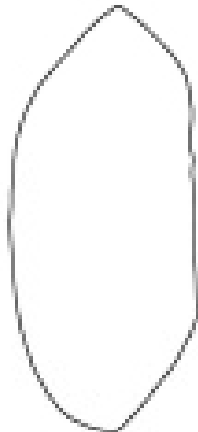

20 mm

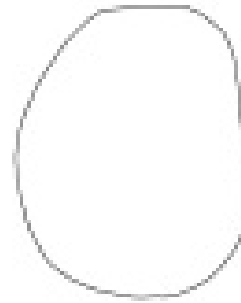
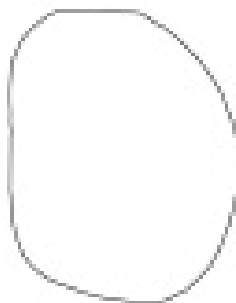

20 mm



20 mm



**B1**

Longitud: 100 mm  
Anchura: 43 mm  
Espesor máximo: 20 mm  
Anchura del corte: --  
Materia prima: Esquisto

Fase 0

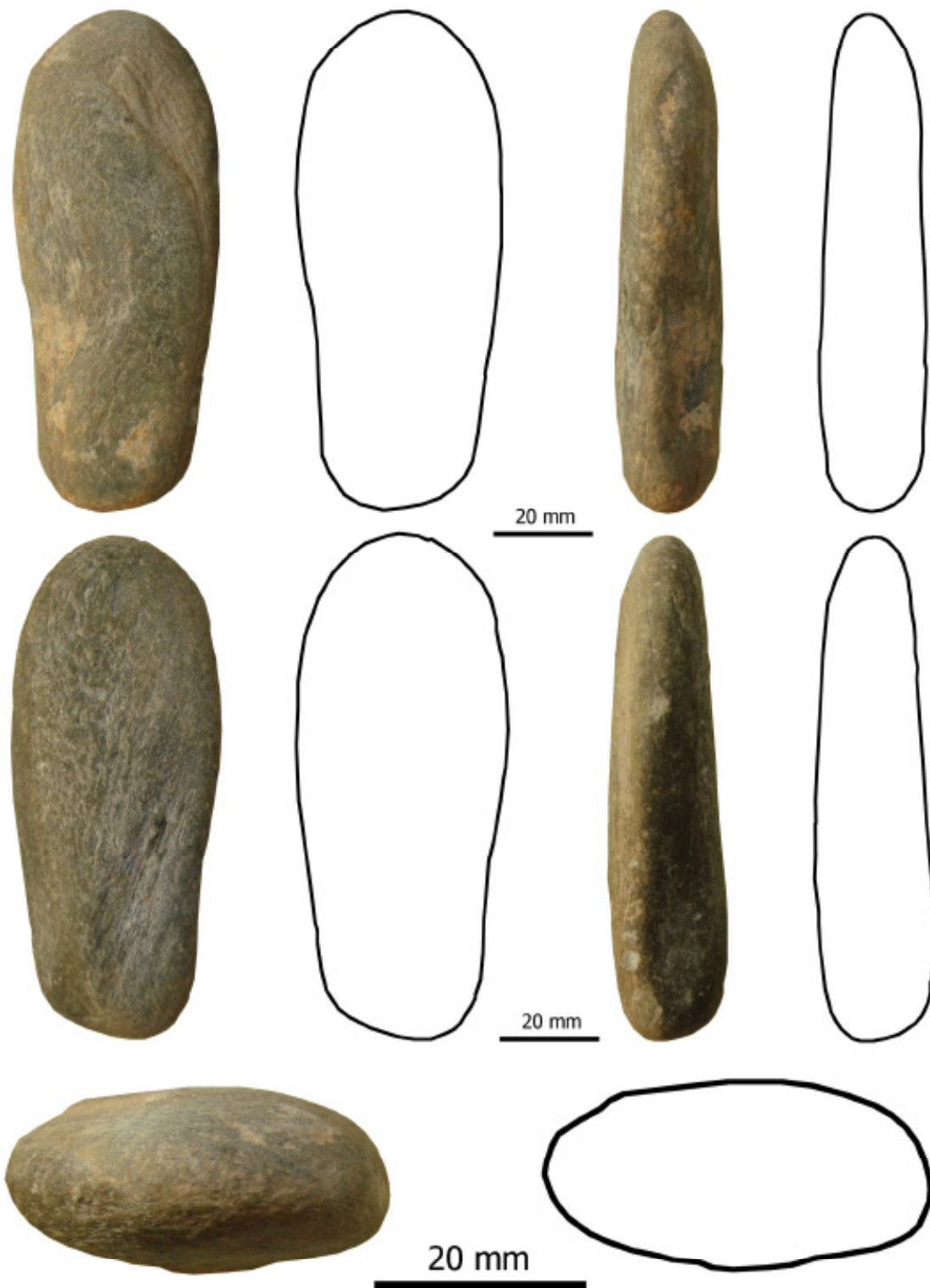

**B1**

Longitud: 99 mm  
Anchura: 43 mm  
Espesor máximo: 20 mm  
Anchura del corte: 13 mm  
Materia prima: Esquisto

**Fase final**  
(200 minutos)

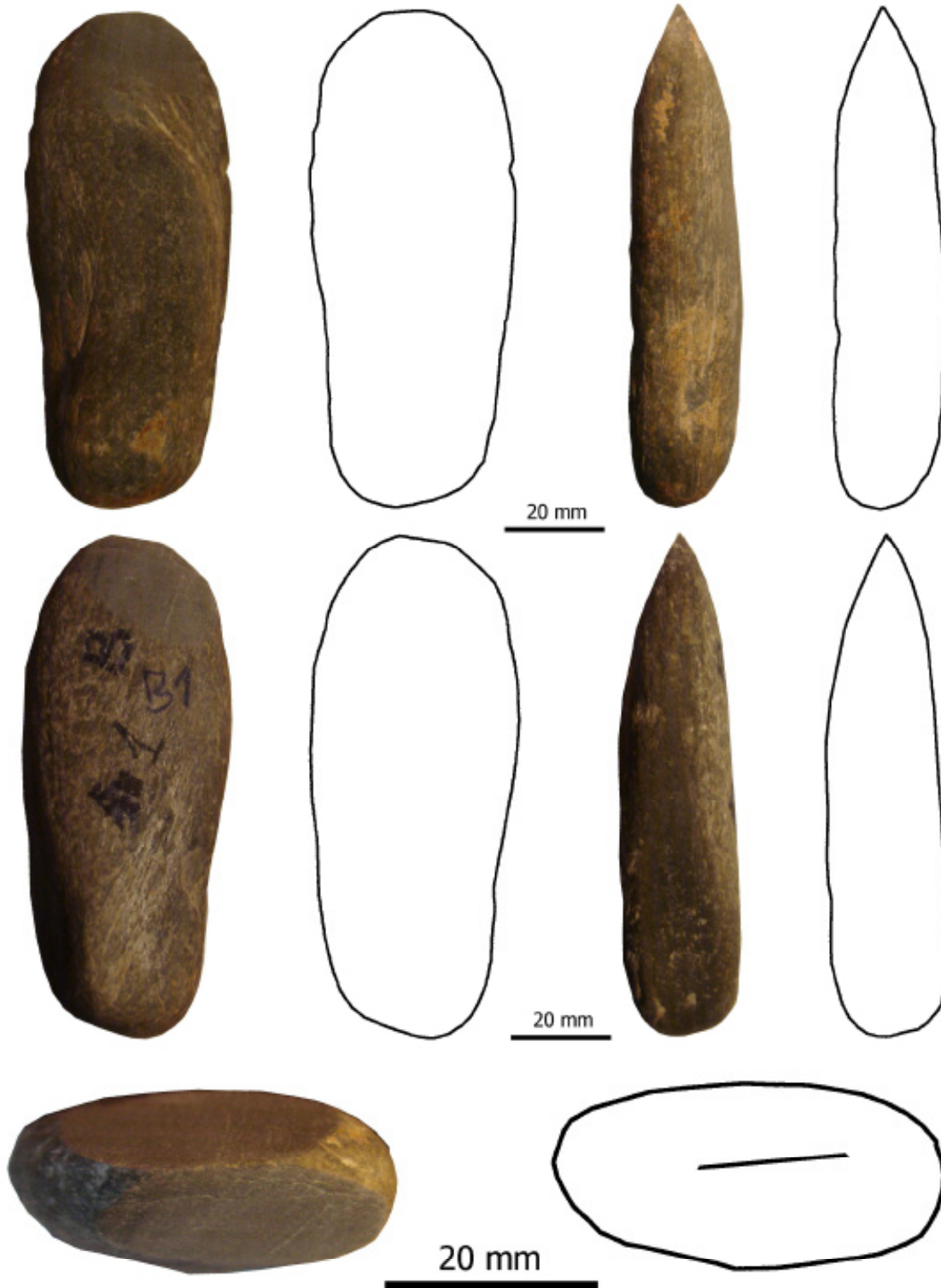

# Archaeological axes





Reference: EU-14-1984

Characteristics of the polished axe:

Length: 109,3

Edge width: 56,5

Archaeological site: Embalse de Urrunaga

Characteristics of the edge:

Amp1: 2,52

Amp2: 0,00

Type of edge: R



50 mm

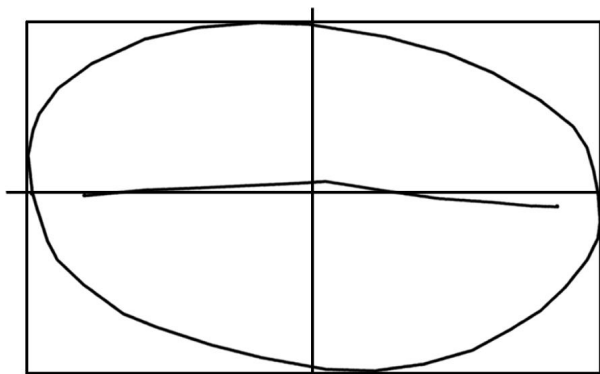

50 mm

Reference: EU-23-144

Characteristics of the polished axe:

Length: 142,5

Edge width: 67,3

Archaeological site: Embalse de Urrunaga

Characteristics of the edge:

Amp1: 0,00

Amp2: 0,00

Type of edge: D

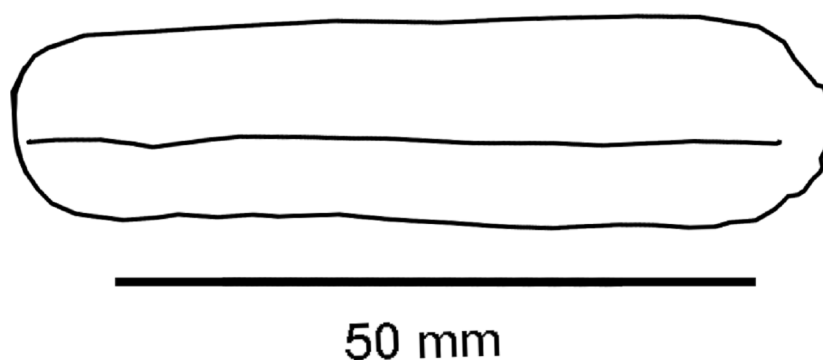

Reference: EU-31-160

Characteristics of the polished axe:

Length: 59,2

Edge width: 31,5

Archaeological site: Embalse de Urrunaga

Characteristics of the edge:

Amp1: 1,53                  Amp2: -2,56

Type of edge: R

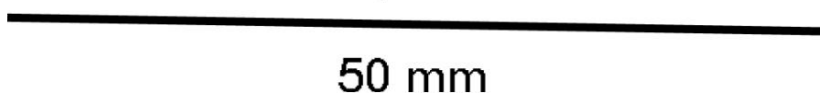
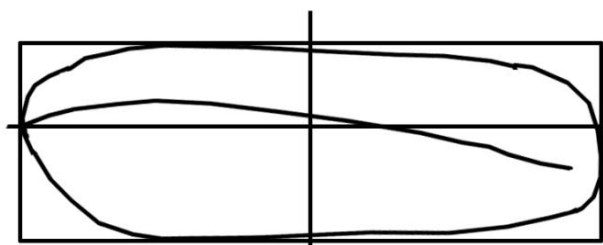
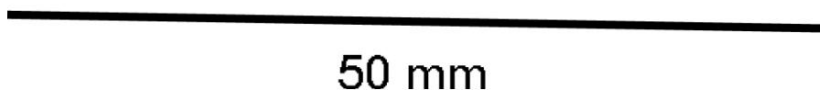

Reference: EU-21-60

Characteristics of the polished axe:

Length: 97,5

Edge width: 27,9

Archaeological site: Embalse de Urrunaga

Characteristics of the edge:

Amp1: 3,38

Amp2: 0,00

Type of edge: R



---

50 mm

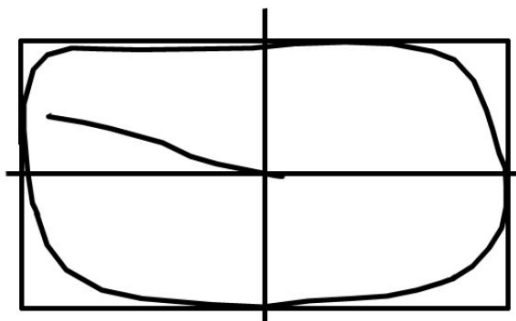

---

50 mm

Reference: EU-32-34

Characteristics of the polished axe:

Length: 38,72

Edge width: 32,8

Archaeological site: Embalse de Urrunaga

Characteristics of the edge:

Amp1: -0,53

Amp2: 0,60

Type of edge: R

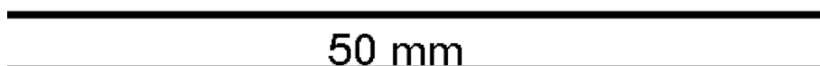
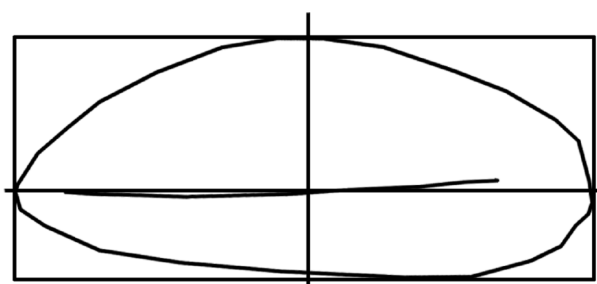

Reference: EU-32-33

Characteristics of the polished axe:

Length: 90,6

Edge width: 40,4

Archaeological site: Embalse de Urrunaga

Characteristics of the edge:

Amp1: 0,00

Amp2: 0,00

Type of edge: D

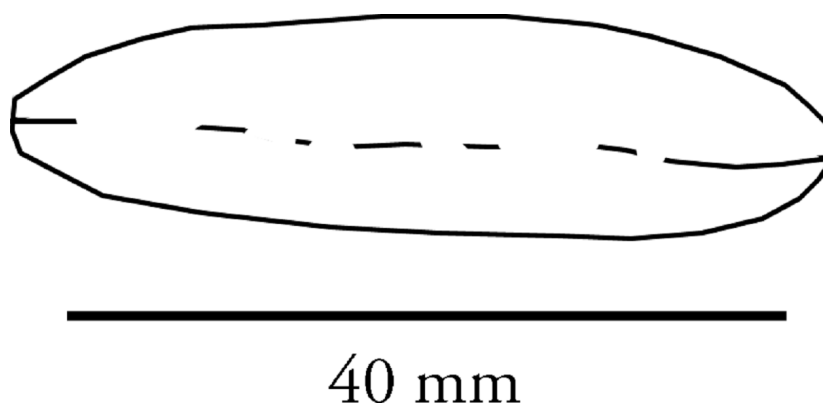
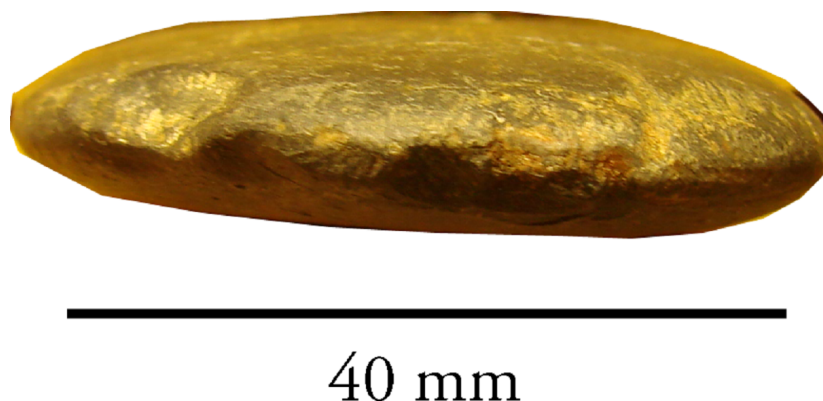

Reference: EU-29-14

Characteristics of the polished axe:

Length: 80,12

Edge width: 47,8

Archaeological site: Embalse de Urrunaga

Characteristics of the edge:

Amp1: 0,95

Amp2: -0,57

Type of edge: R

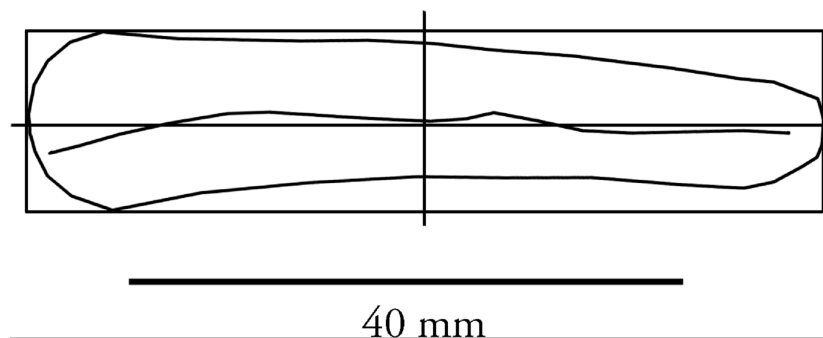
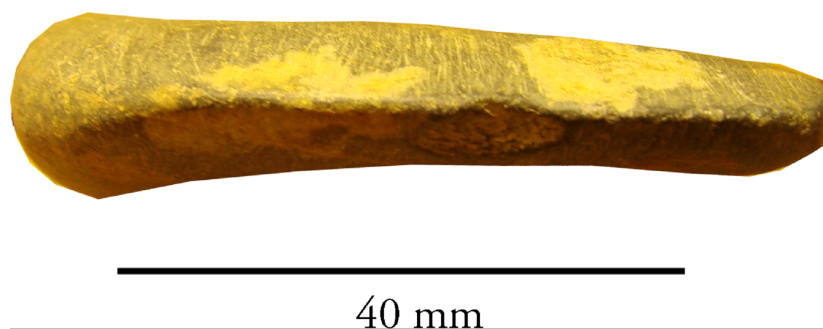

Reference: EU-4-41

Characteristics of the polished axe:

Length: 79,2

Edge width: 32,6

Archaeological site: Embalse de Urrunaga

Characteristics of the edge:

Amp1: 1,02                      Amp2: -1,26

Type of edge: R



50 mm

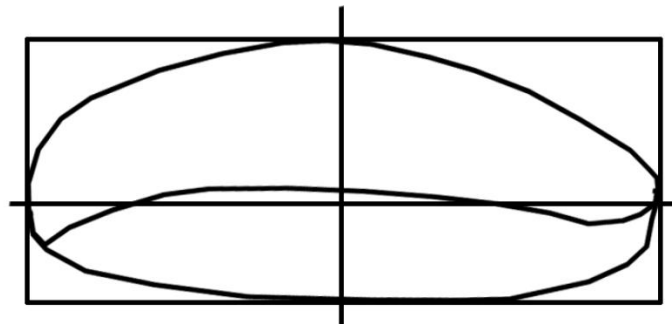

50 mm



Reference: EU-23-44

Characteristics of the polished axe:

Length: 77,5

Edge width: 48,9

Archaeological site: Embalse de Urrunaga

Characteristics of the edge:

Amp1: 0,00

Amp2: 0,00

Type of edge: D

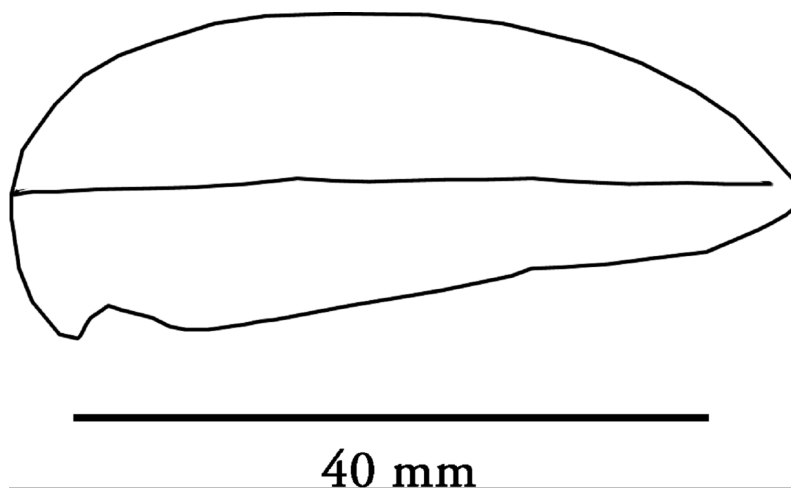
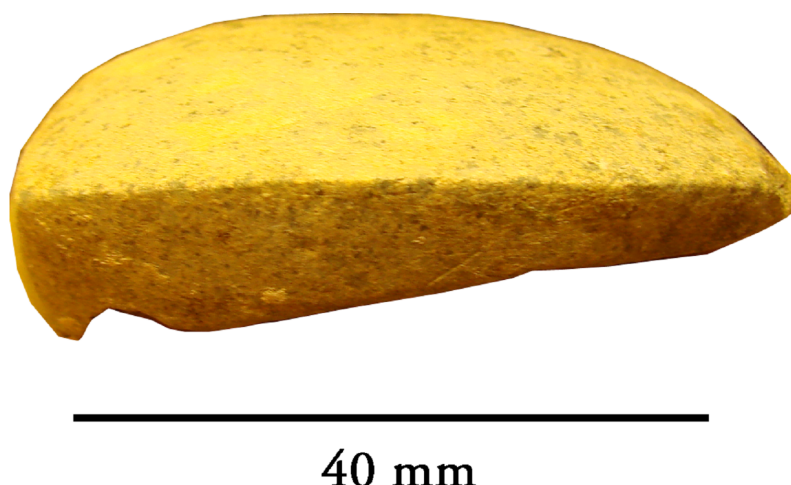

Reference: EU-24-76

Characteristics of the polished axe:

Length: 96,7

Edge width: 43,6

Archaeological site: Embalse de Urrunaga

Characteristics of the edge:

Amp1: 0,00

Amp2: 0,00

Type of edge: D

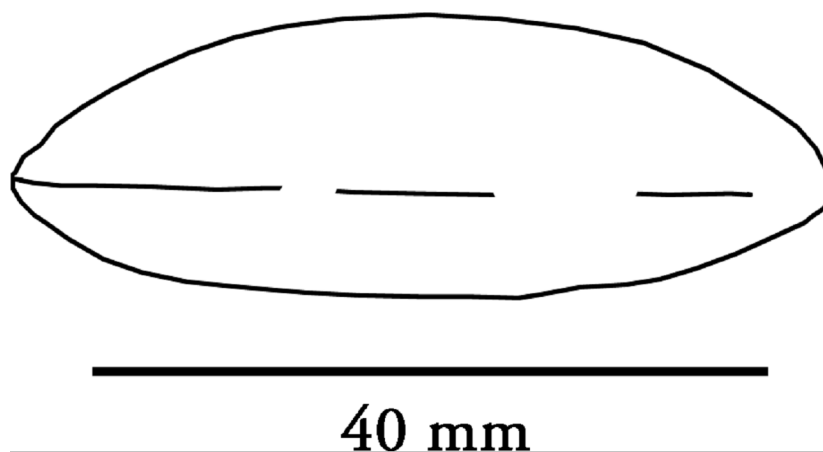
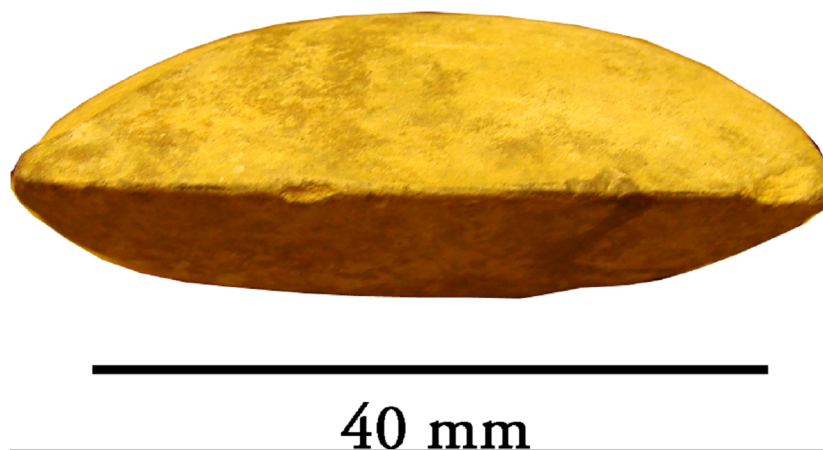

Reference: EU-24-45

Characteristics of the polished axe:

Length: 42,6

Edge width: 38,7

Archaeological site: Embalse de Urrunaga

Characteristics of the edge:

Amp1: 0,54

Amp2: -1,66

Type of edge: R

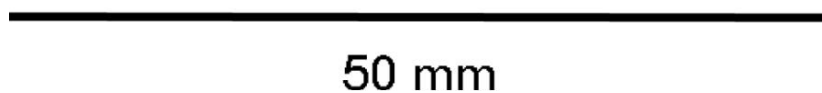
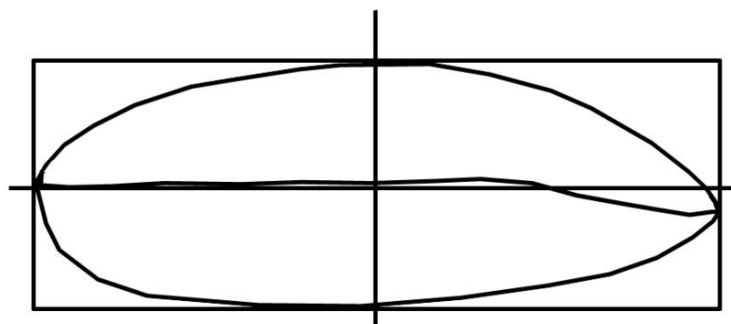
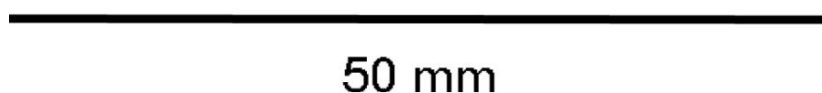

Reference: EU-24-46

Characteristics of the polished axe:

Length: 29

Edge width: 11,4

Archaeological site: Embalse de Urrunaga

Characteristics of the edge:

Amp1: 0,59

Amp2: -0,26

Type of edge: R



---

20 mm

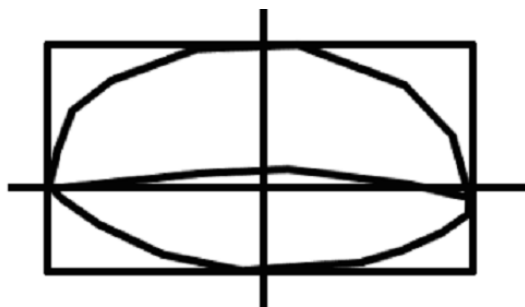

20 mm

Reference: EU-11-147

Characteristics of the polished axe:

Length: 118,5

Edge width: 58

Archaeological site: Embalse de Urrunaga

Characteristics of the edge:

Amp1: 0,00

Amp2: -2,70

Type of edge: R

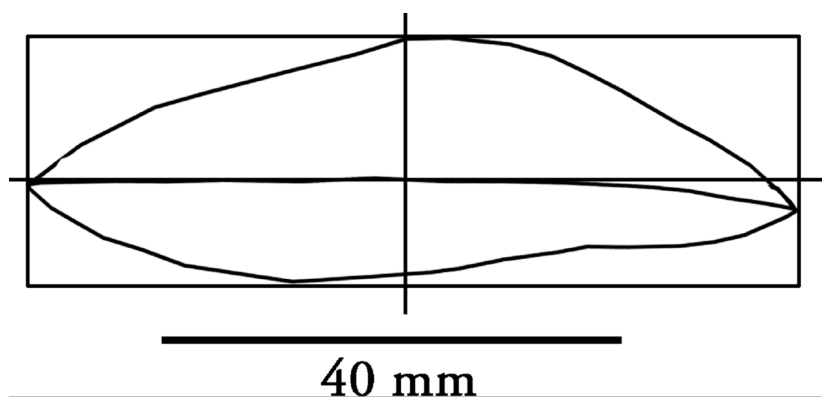
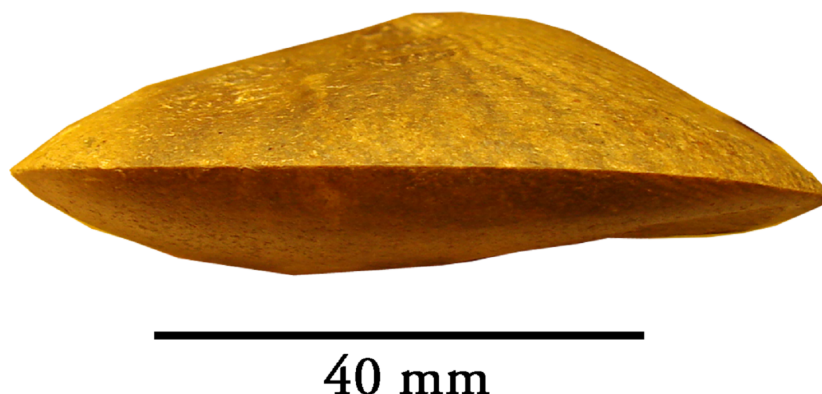

Reference: EU-A2-152

Characteristics of the polished axe:

Length: 59,1

Edge width: 39,1

Archaeological site: Embalse de Urrunaga

Characteristics of the edge:

Amp1: 2,54                      Amp2: -0,43

Type of edge: R



50 mm

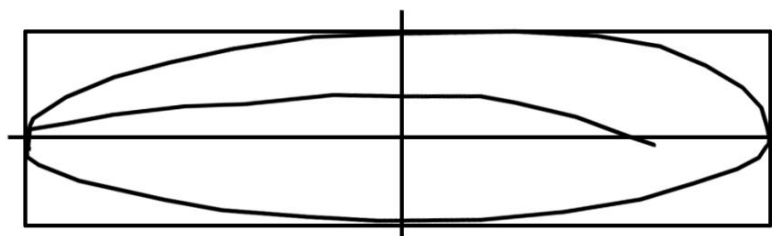

50 mm

Reference: EU-5-150

Characteristics of the polished axe:

Length: 32,5

Edge width: 23

Archaeological site: Embalse de Urrunaga

Characteristics of the edge:

Amp1: -1,35                  Amp2: 0,00

Type of edge: L

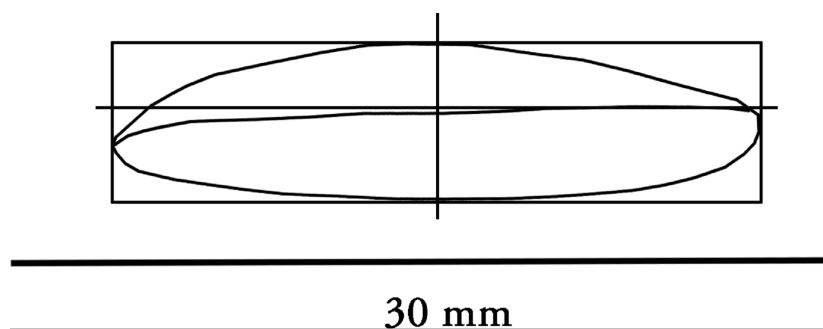
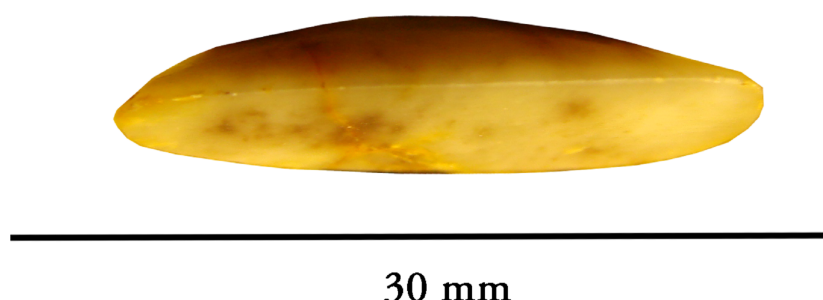

Reference: EU-A1-39

Characteristics of the polished axe:

Length: 125,6

Edge width: 58,1

Archaeological site: Embalse de Urrunaga

Characteristics of the edge:

Amp1: 0,00

Amp2: 0,00

Type of edge: D

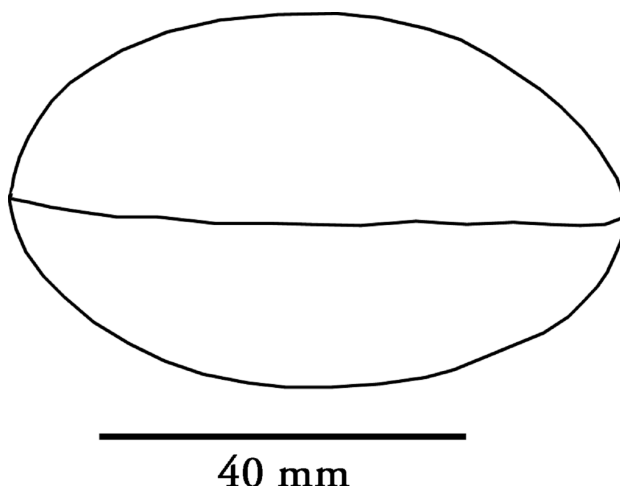



Reference: EU-39-70

Characteristics of the polished axe:

Length: 57,9

Edge width: 44,1

Archaeological site: Embalse de Urrunaga

Characteristics of the edge:

Amp1: 0,00

Amp2: 0,00

Type of edge: D



50 mm

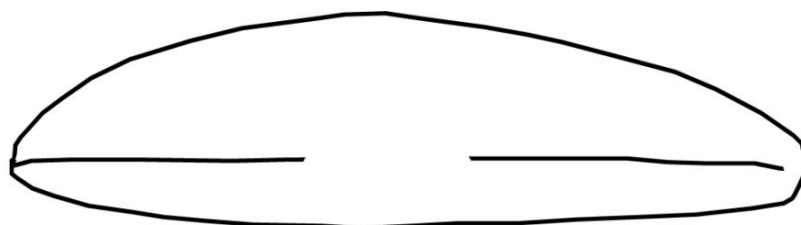

50 mm

Reference: EU-39-72

Characteristics of the polished axe:

Length: 56,7

Edge width: 21

Archaeological site: Embalse de Urrunaga

Characteristics of the edge:

Amp1: -0,83

Amp2: 0,83

Type of edge: L

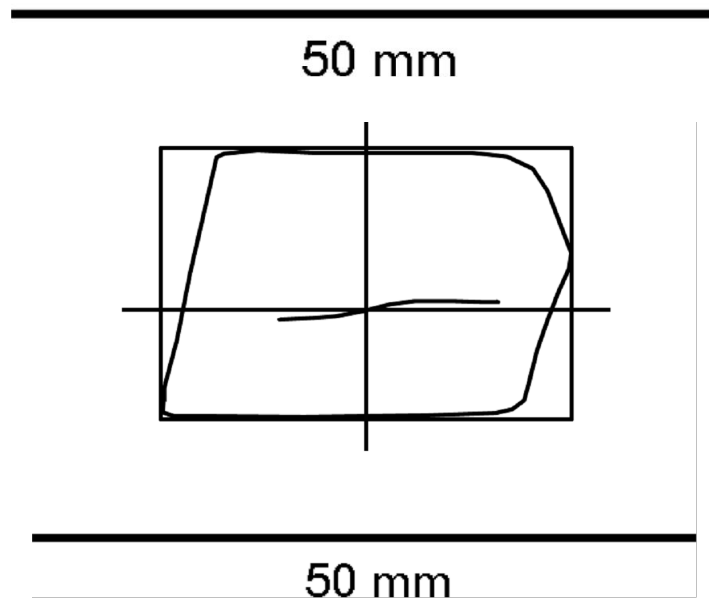

Reference: EU-39-71

Characteristics of the polished axe:

Length: 34,9

Edge width: 11,5

Archaeological site: Embalse de Urrunaga

Characteristics of the edge:

Amp1: 0,00

Amp2: 0,00

Type of edge: D



---

50 mm

---

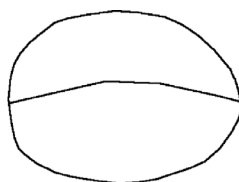

---

50 mm

---

Reference: EU-39-151

Characteristics of the polished axe:

Length: 76,4

Edge width: 41,5

Archaeological site: Embalse de Urrunaga

Characteristics of the edge:

Amp1: 0,00

Amp2: 0,00

Type of edge: D



50 mm

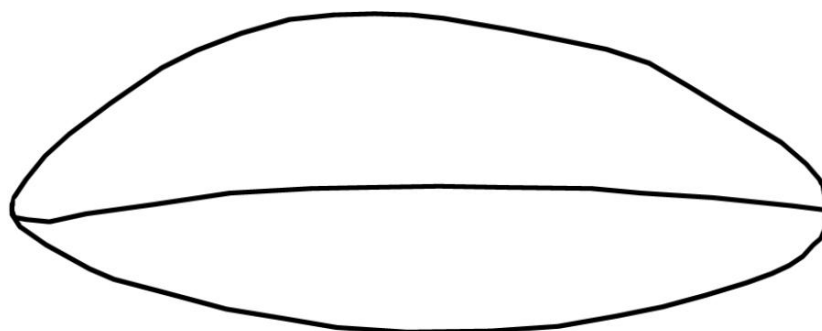

50 mm

Reference: EU-A1-146

Characteristics of the polished axe:

Length:

Edge width: 65

Archaeological site: Embalse de Urrunaga

Characteristics of the edge:

Amp1: -1,34                  Amp2: 0,86

Type of edge: L

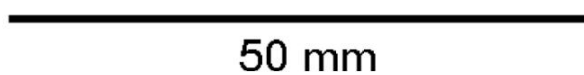
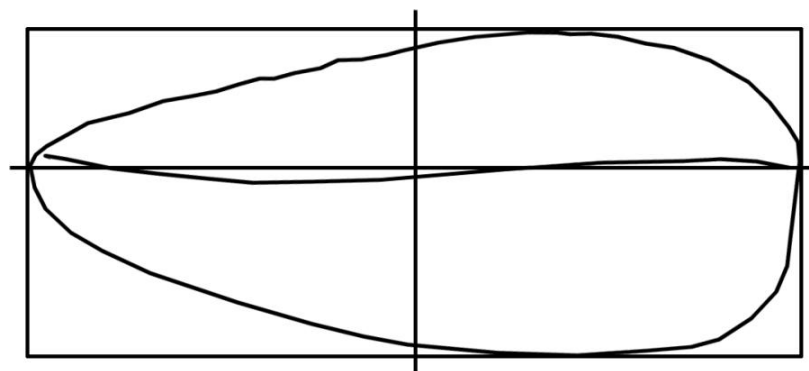
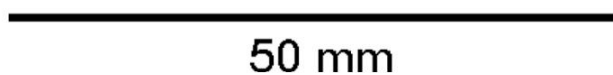
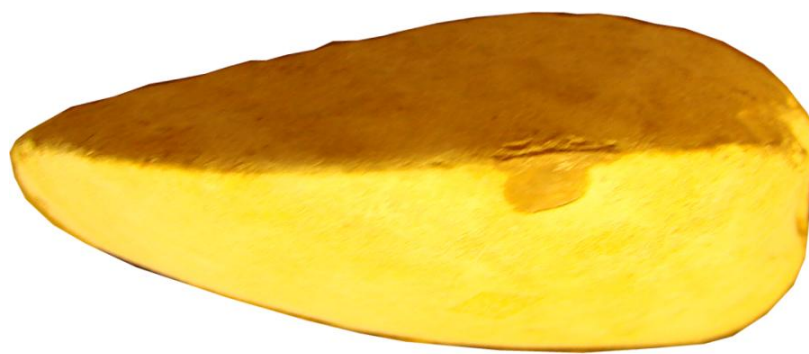

Reference: DSB-2004

Characteristics of the polished axe:

Length: 77,7

Edge width: 43

Archaeological site: Dehesa de San Bartolomé

Characteristics of the edge:

Amp1: 0,00

Amp2: 0,00

Type of edge: D

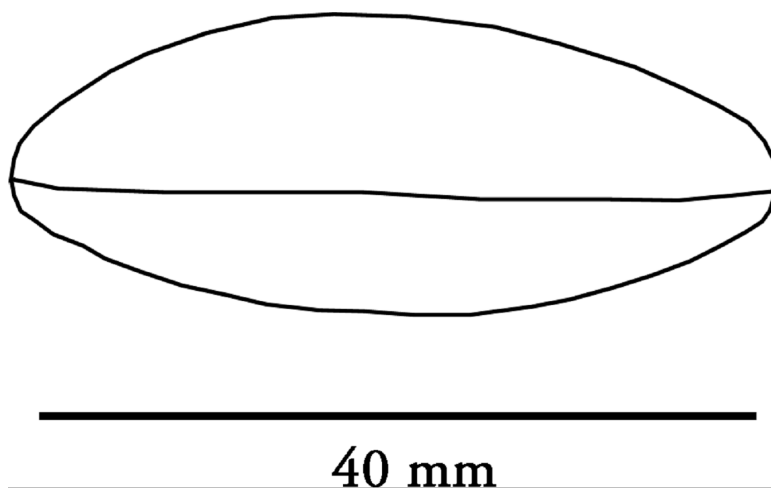

Reference: DSB-2016

Characteristics of the polished axe:

Length: 119,5

Edge width: 47

Archaeological site: Dehesa de San Bartolomé

Characteristics of the edge:

Amp1: 0,00

Amp2: 0,00

Type of edge: D

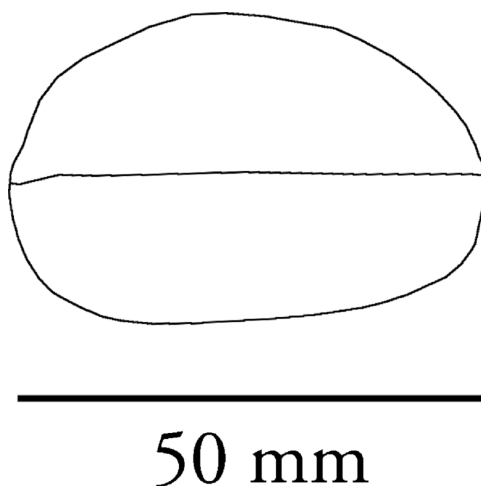

Reference: DSB-2010

Characteristics of the polished axe:

Length: 107,8

Edge width: 26,5

Archaeological site: Dehesa de San Bartolomé

Characteristics of the edge:

Amp1: 0,76

Amp2: 0,00

Type of edge: R

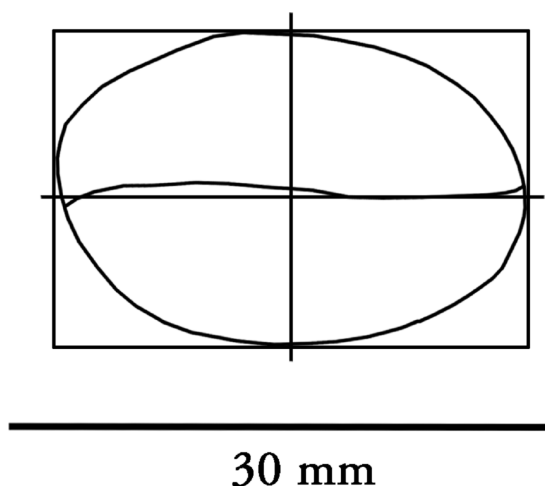



Reference: DSB-2011

Characteristics of the polished axe:

Length: 131,3

Edge width: 39,2

Archaeological site: Dehesa de San Bartolomé

Characteristics of the edge:

Amp1: 0,00

Amp2: 0,00

Type of edge: D

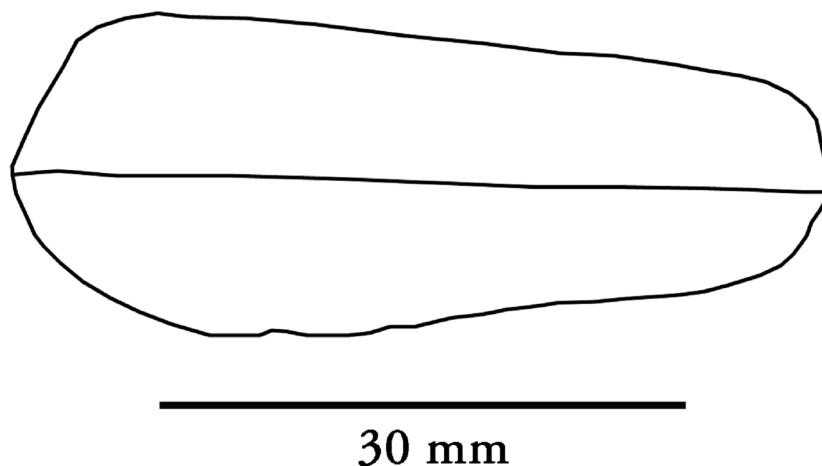

Reference: DSB-2031

Characteristics of the polished axe:

Length:

Edge width: 50,7

Archaeological site: Dehesa de San Bartolomé

Characteristics of the edge:

Amp1: 0,00

Amp2: 0,00

Type of edge: D

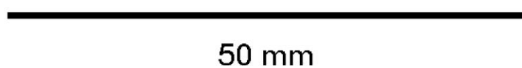

50 mm

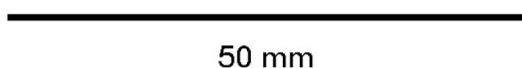
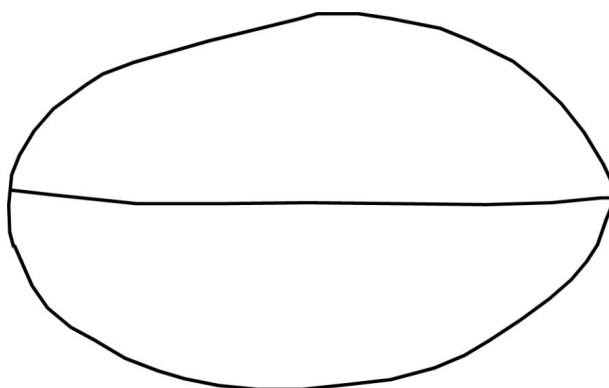

50 mm

Reference: DSB-2014

Characteristics of the polished axe:

Length:

Edge width: 59,9

Archaeological site: Dehesa de San Bartolomé

Characteristics of the edge:

Amp1: 0,00

Amp2: 0,00

Type of edge: D

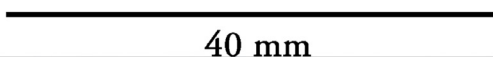

40 mm

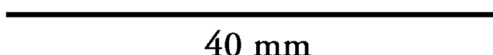
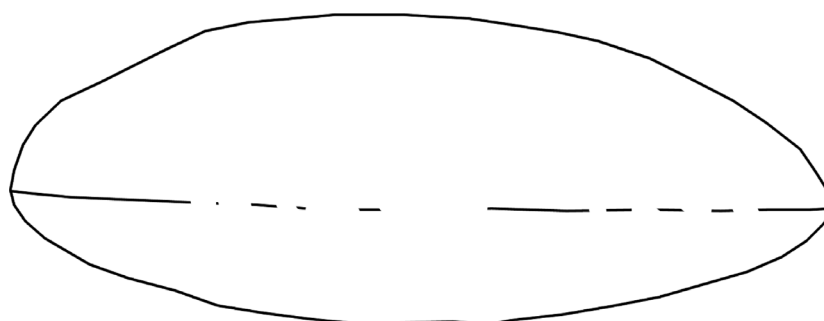

40 mm

Reference: DSB-2003

Characteristics of the polished axe:

Length: 137,7

Edge width: 56,28

Archaeological site: Dehesa de San Bartolomé

Characteristics of the edge:

Amp1: 0,00

Amp2: 0,00

Type of edge: D

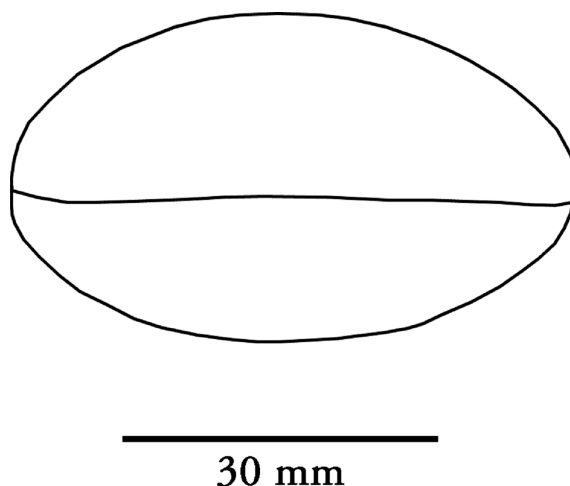

Reference: 1066 Fdz Medrano

Characteristics of the polished axe:

Length: 51,20

Edge width: 31,67

Archaeological site:

Characteristics of the edge:

Amp1: 0,54

Amp2: -0,54

Type of edge: R

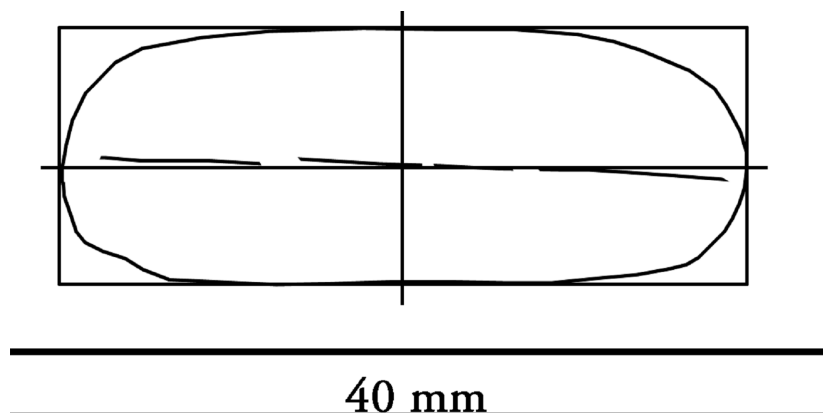
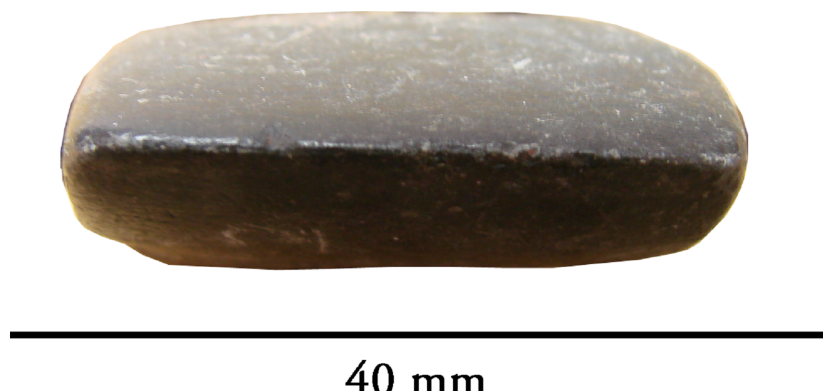

Reference: 1065 Fdz Medrano

Characteristics of the polished axe:

Length: 52,78

Edge width: 40,05

Archaeological site:

Characteristics of the edge:

Amp1: 0,00                  Amp2: 0,00

Type of edge: D



---

50 mm

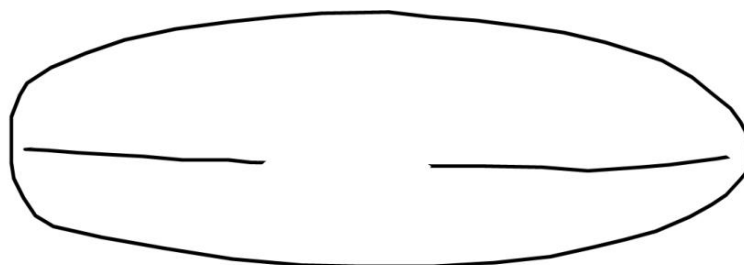

---

50 mm

Reference: 1360 Fdz Medrano

Characteristics of the polished axe:

Length:

Edge width: 45,22

Archaeological site:

Characteristics of the edge:

Amp1: 0,00

Amp2: 0,00

Type of edge: D



40 mm

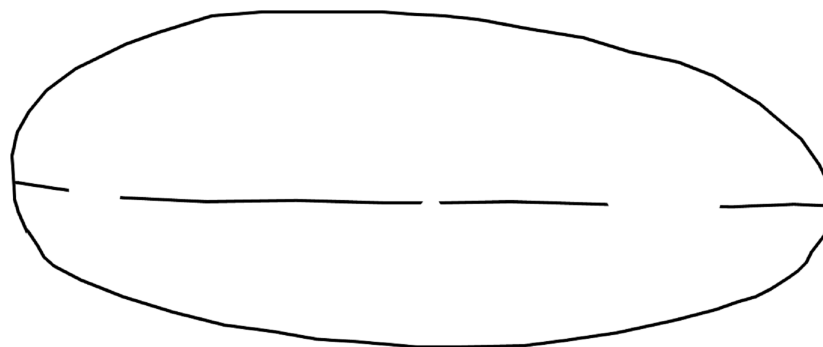

40 mm

Reference: 1077 Fdz Medrano

Characteristics of the polished axe:

Length: 68,49

Edge width: 31,12

Archaeological site:

Characteristics of the edge:

Amp1: 2,10

Amp2: -1,19

Type of edge: R

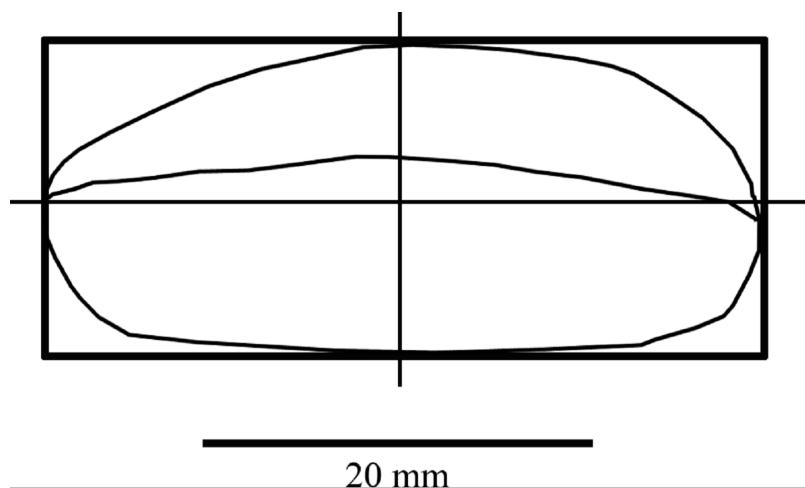



## Reference: N°104 CAA

### Characteristics of the polished axe:

Length: 85,5

Edge width: 48,6

Archaeological site: Pipaón

### Characteristics of the edge:

Amp1: 0,00

Amp2: 0,00

Type of edge: D

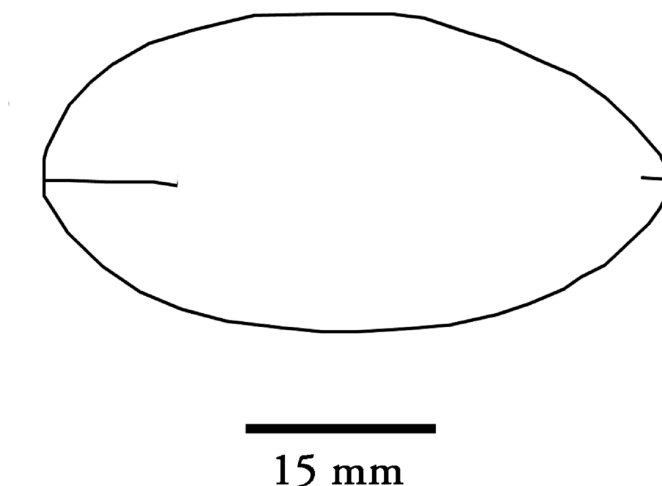

Reference: SMAR Fondos de caja

Characteristics of the polished axe:

Length: 62,6

Edge width: 51,2

Archaeological site: San Martín

Characteristics of the edge:

Amp1: 0,00

Amp2: 0,00

Type of edge: D



20 mm

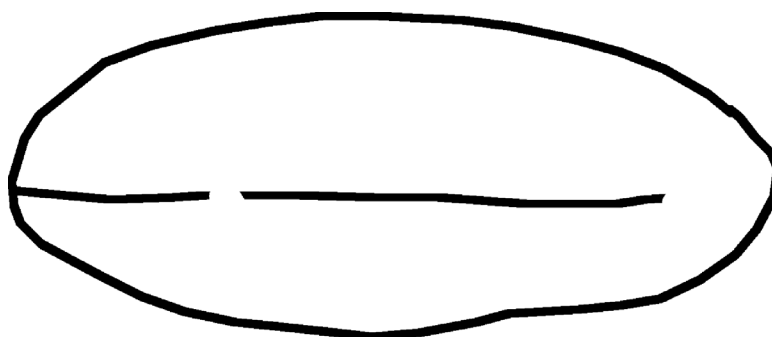

20 mm

Reference: N° 11 CAA

Characteristics of the polished axe:

Length: 118,3

Edge width: 50,5

Archaeological site: Ladera La Majada

Characteristics of the edge:

Amp1: 0,00

Amp2: 0,00

Type of edge: D



15 mm

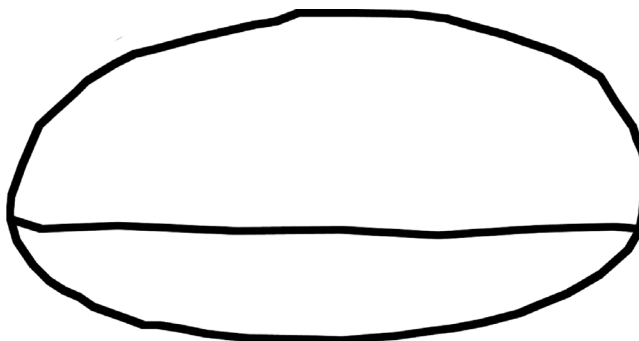

15 mm

Reference: N° 105 CAA

Characteristics of the polished axe:

Length: 100,7

Edge width: 50,2

Archaeological site: El Huerto

Characteristics of the edge:

Amp1: 0,00

Amp2: 0,00

Type of edge: D



15 mm

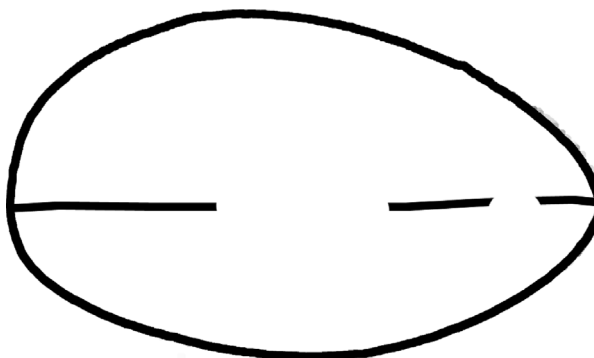

15 mm

## Reference: Exposición BIBAT

### Characteristics of the polished axe:

Length: 106,5

Edge width: 58,3

Archaeological site: Los Cascajos

### Characteristics of the edge:

Amp1: 2,78

Amp2: -1,11

Type of edge: R

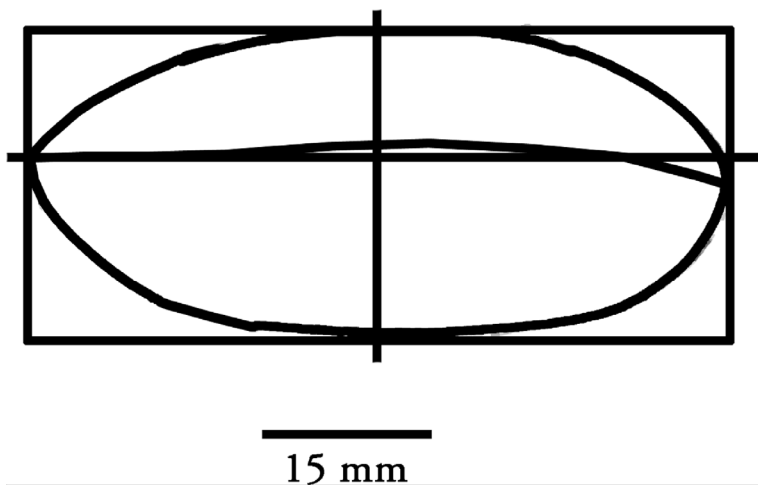
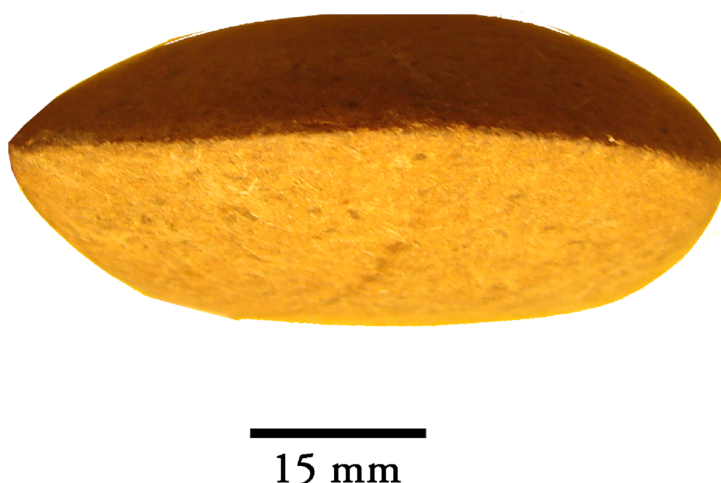

## Reference: Exposición BIBAT

### Characteristics of the polished axe:

Length: 74,2

Edge width: 48,6

Archaeological site: Los Cascajos

### Characteristics of the edge:

Amp1: 0,00

Amp2: 0,00

Type of edge: D



15 mm

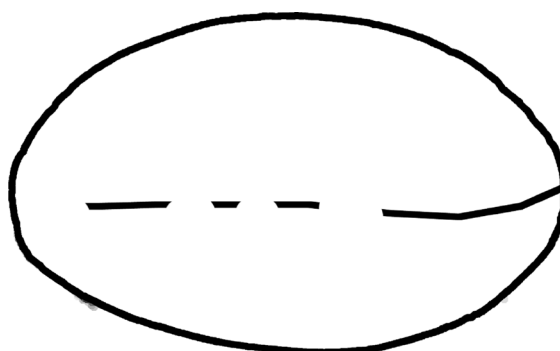

15 mm

Reference: LCS

Characteristics of the polished axe:

Length: (34,4)

Edge width: 40,8

Archaeological site: Las Canteras

Characteristics of the edge:

Amp1: 0,00

Amp2: 0,00

Type of edge: D



20 mm

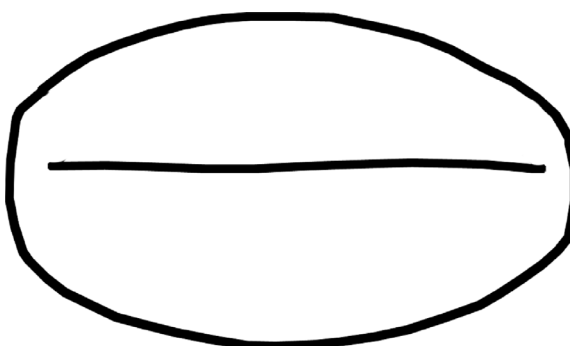

20 mm

Reference: LCS

Characteristics of the polished axe:

Length: (48,1)

Edge width: 39,0

Archaeological site: Las Canteras

Characteristics of the edge:

Amp1: 0,00

Amp2: 0,00

Type of edge: D

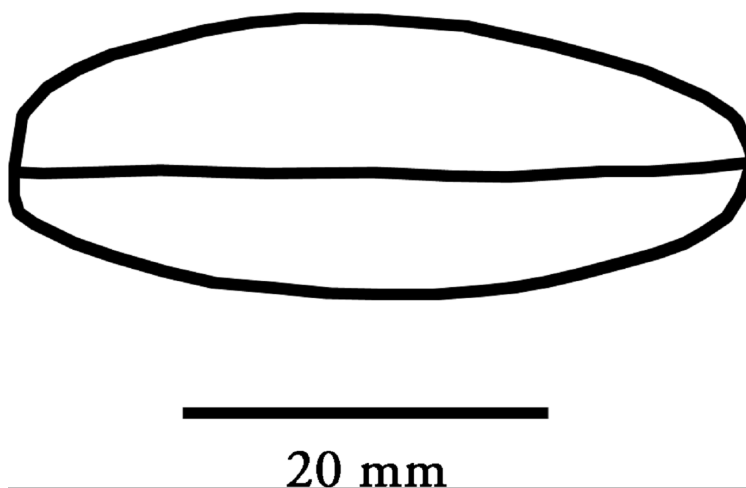
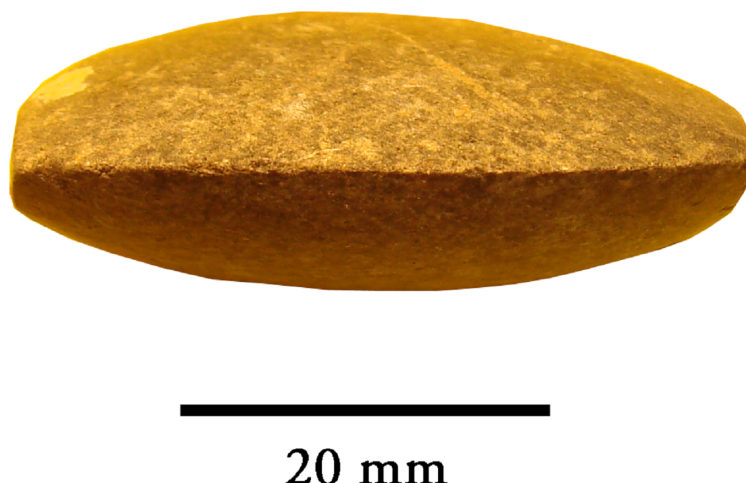



Reference: 095.1.4

Characteristics of the polished axe:

Length: 170,8

Edge width: 30,5

Archaeological site:

Characteristics of the edge:

Amp1: 0,00

Amp2: 0,00

Type of edge: D



30 mm

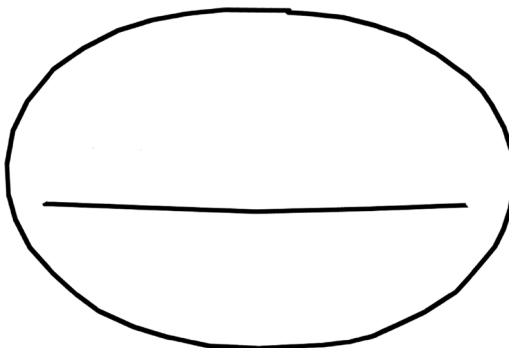

30 mm

Reference: 105.4.2 en deposito

Characteristics of the polished axe:

Length: 160,00

Edge width: 46,00

Archaeological site: Paso Maenillo

Characteristics of the edge:

Amp1:

Amp2:

Type of edge: D



20 mm

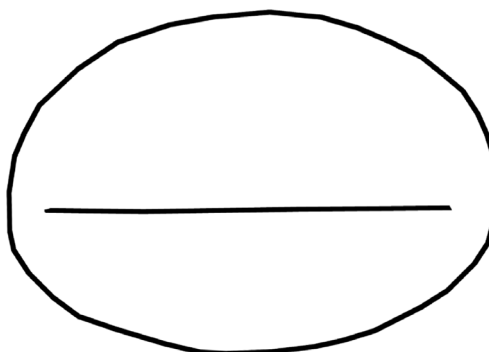

20 mm

Reference: XR 268.3.1

Characteristics of the polished axe:

Length: 225,00

Edge width: 42,00

Archaeological site:

Characteristics of the edge:

Amp1: 1,30

Amp2: -1,52

Type of edge: R



20 mm

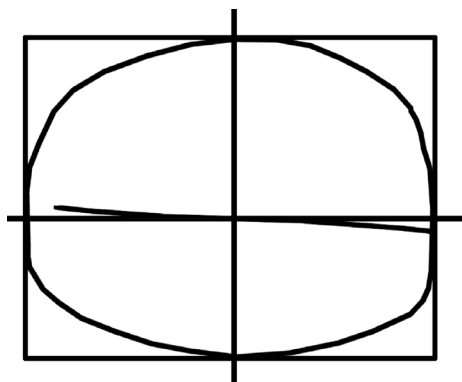

20 mm

Reference: 099.3.2

Characteristics of the polished axe:

Length: (81,00)

Edge width: 66,00

Archaeological site:

Characteristics of the edge:

Amp1: 0,00

Amp2: 0,00

Type of edge: D



25 mm

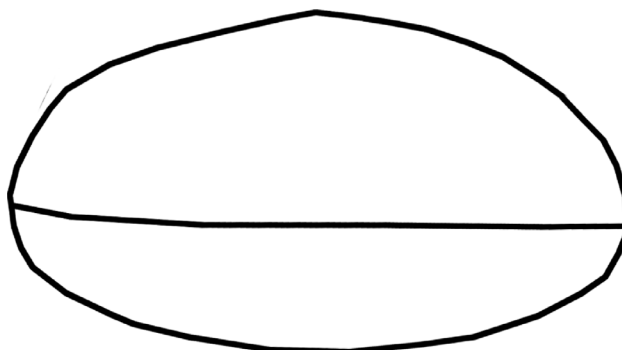

25 mm

Reference: 099.3.2

Characteristics of the polished axe:

Length: (46,00)

Edge width: 50,00

Archaeological site:

Characteristics of the edge:

Amp1: 0,00

Amp2: 0,00

Type of edge: D

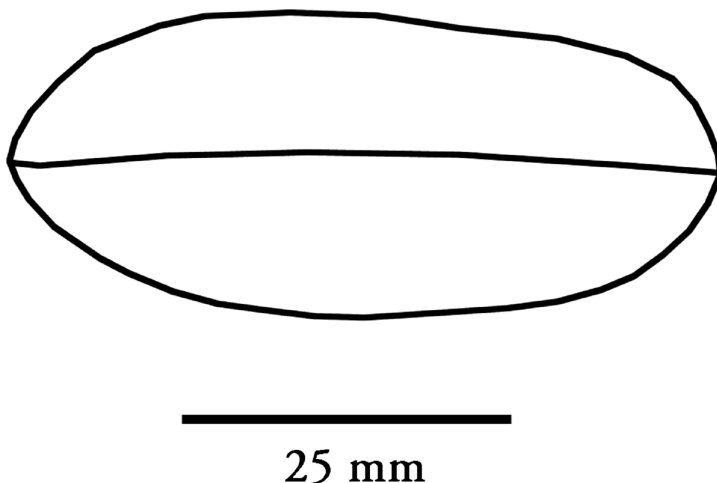
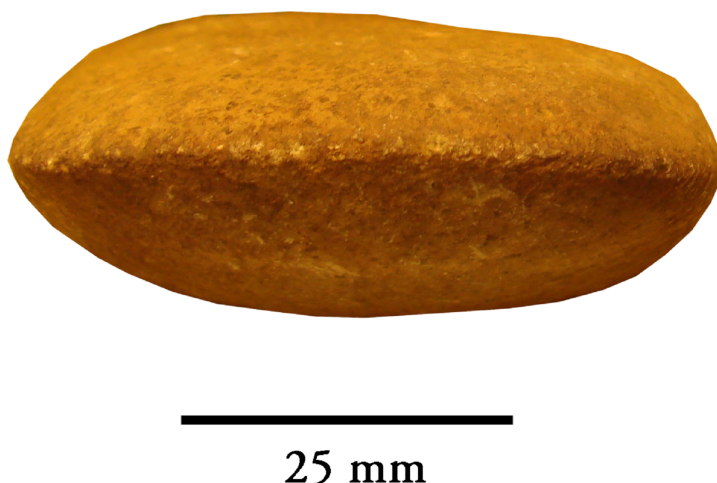

Reference: 099.3.2 (267)

Characteristics of the polished axe:

Length: 83,00

Edge width: 43,00

Archaeological site:

Characteristics of the edge:

Amp1: 0,00

Amp2: 0,00

Type of edge: D

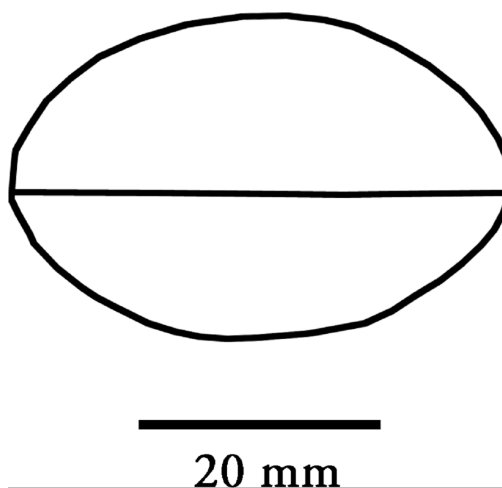
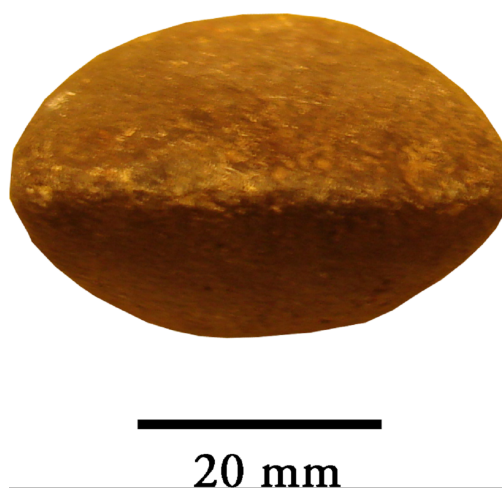

Reference: C.A.A. FM

Characteristics of the polished axe:

Length: 94,00

Edge width: 33,00

Archaeological site: Finca Maroto

Characteristics of the edge:

Amp1: 0,00

Amp2: -1,86

Type of edge: R

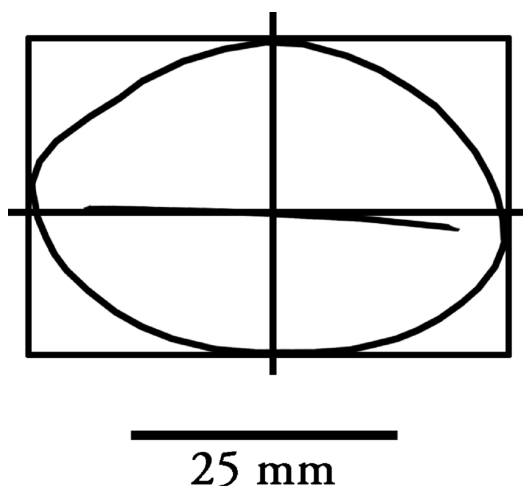
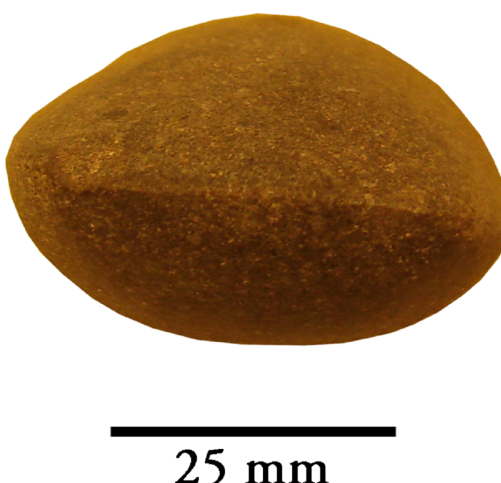

Reference: 099.3.6

Characteristics of the polished axe:

Length: (104,00)

Edge width: 50,00

Archaeological site: Laguardia

Characteristics of the edge:

Amp1: 0,00

Amp2: 0,00

Type of edge: D

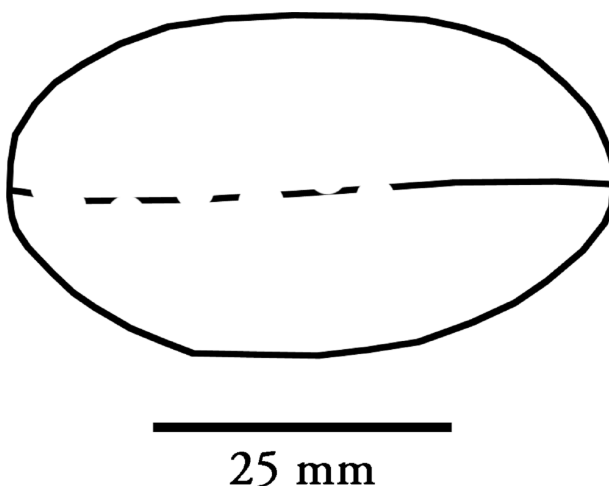



Reference: BER 099.3.6

Characteristics of the polished axe:

Length: 110,00

Edge width: 52,00

Archaeological site: Beraza

Characteristics of the edge:

Amp1: 0,00

Amp2: 0,00

Type of edge: D

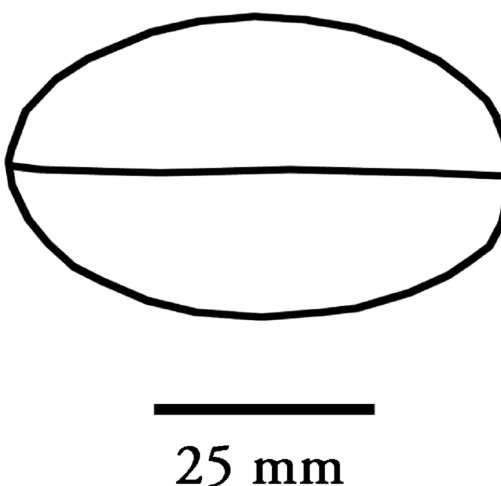
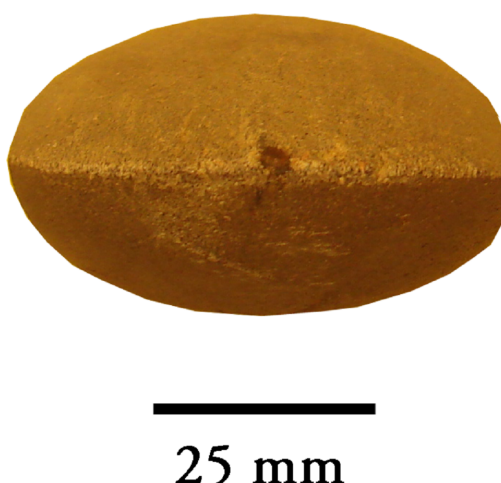

Reference: LLO 095.4.6

Characteristics of the polished axe:

Length: 122,000

Edge width: 50,00

Archaeological site: La Llosa

Characteristics of the edge:

Amp1: 0,00

Amp2: 0,00

Type of edge: D



25 mm

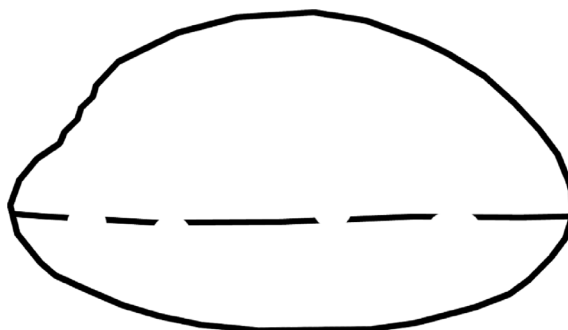

25 mm

Reference: n° 104 CAA (p.35)

Characteristics of the polished axe:

Length: 86,00

Edge width: 50,00

Archaeological site: Los huertos

Characteristics of the edge:

Amp1: 0,00

Amp2: 0,00

Type of edge: D

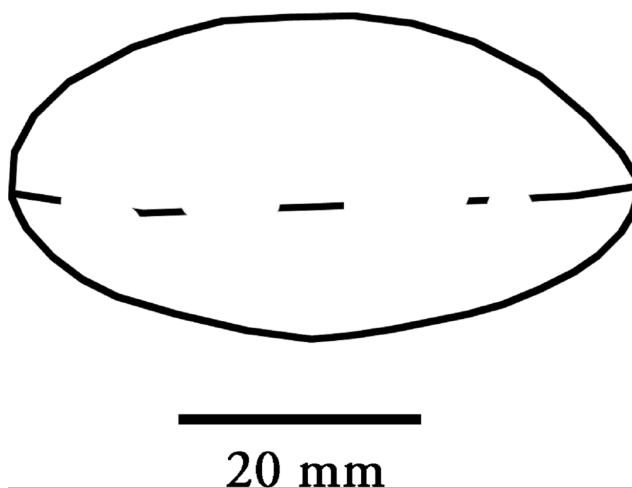
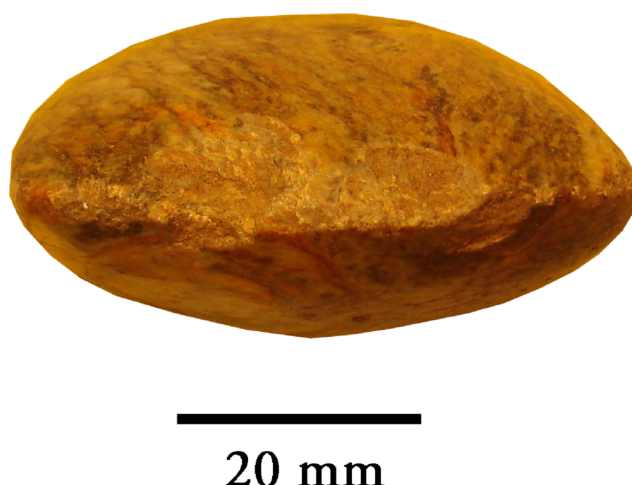

Reference: SMAR caja nº 46

Characteristics of the polished axe:

Length: 64,00

Edge width: 54,00

Archaeological site: San Martin

Characteristics of the edge:

Amp1: 0,00

Amp2: 0,00

Type of edge: D

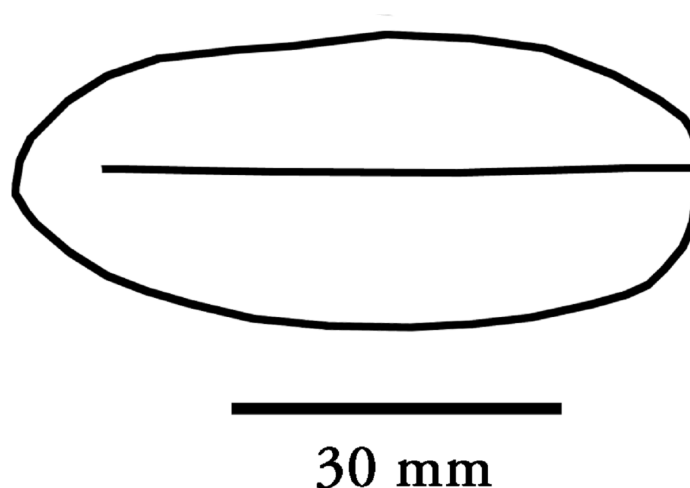

Reference: DSB 099.1.3

Characteristics of the polished axe:

Length: 123,00

Edge width: 44,00

Archaeological site: Dehesa de San Bartolomé

Characteristics of the edge:

Amp1: 0,00

Amp2: 0,00

Type of edge: D

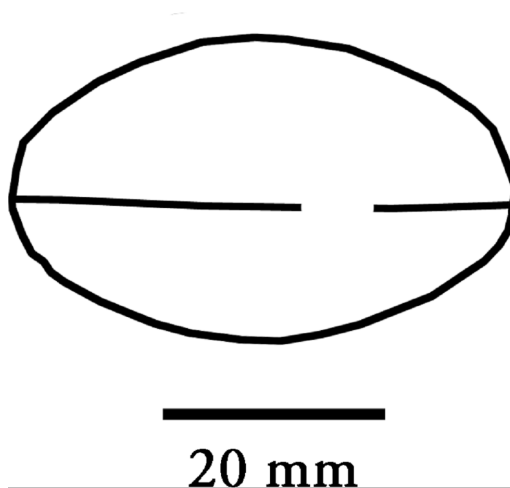
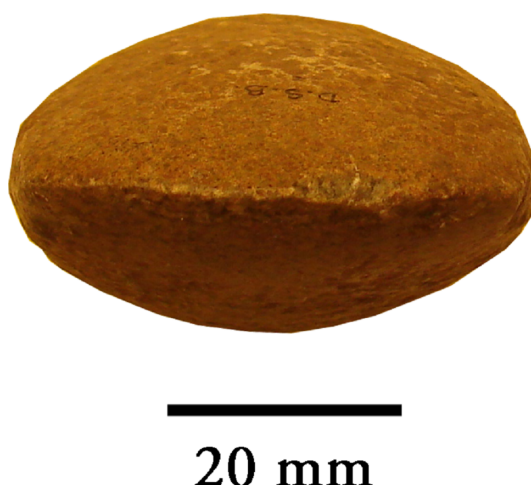

Reference: 94.2.6

Characteristics of the polished axe:

Length: 113,00

Edge width: 56,00

Archaeological site: El Llano

Characteristics of the edge:

Amp1: 0,00

Amp2: 0,00

Type of edge: D

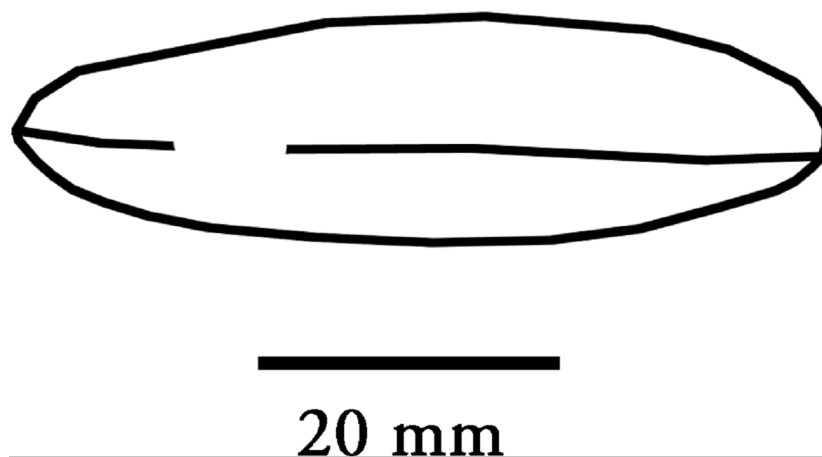
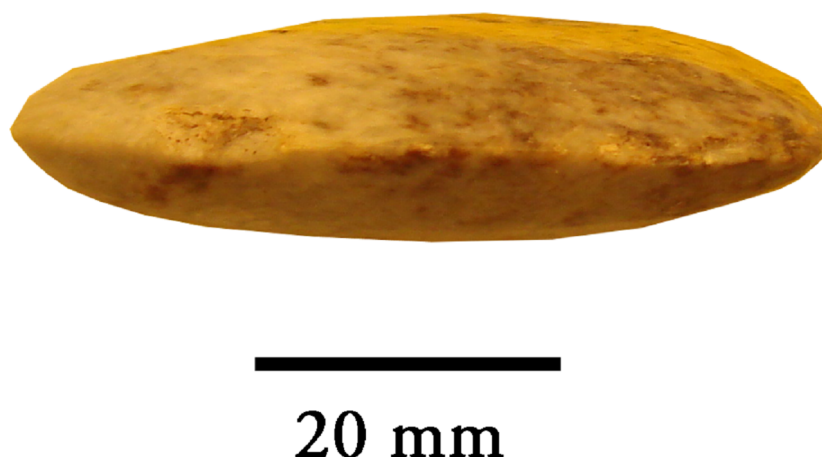

Reference: Sala 097.3.1

Characteristics of the polished axe:

Length: 101,00

Edge width: 53,00

Archaeological site: Salas

Characteristics of the edge:

Amp1: 0,00

Amp2: 0,00

Type of edge: D

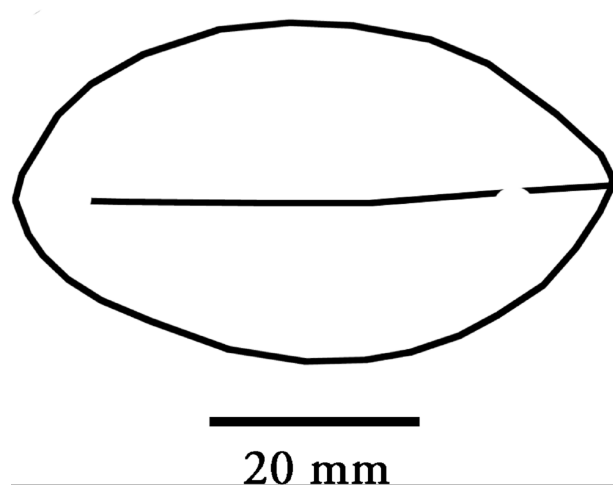

Reference: 1360 Fdz. Medrano

Characteristics of the polished axe:

Length: (69,00)

Edge width: 45,00

Archaeological site: Campo de los Palacios

Characteristics of the edge:

Amp1: 0,00

Amp2: 0,00

Type of edge: D

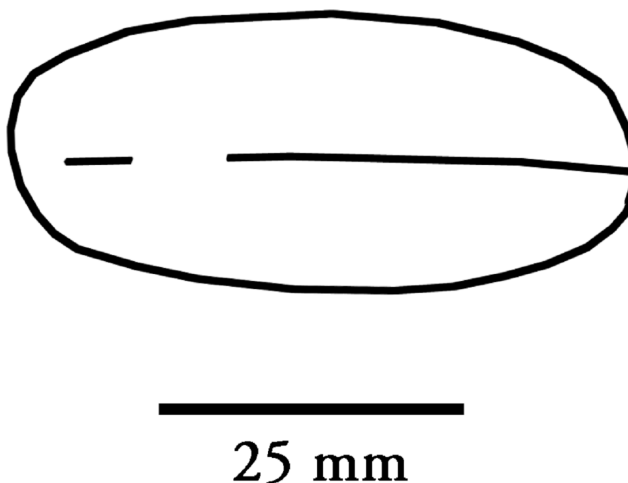
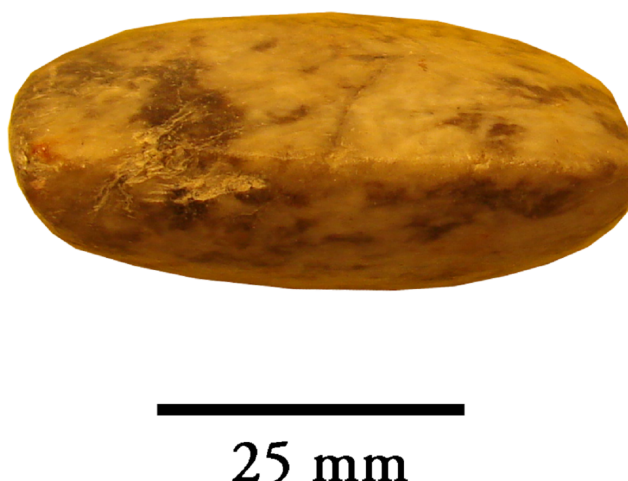



Reference: 1077 Fdz. Medrano

Characteristics of the polished axe:

Length: 70,00

Edge width: 32,00

Archaeological site: Gasteiz

Characteristics of the edge:

Amp1: 0,91

Amp2: -1,09

Type of edge: R

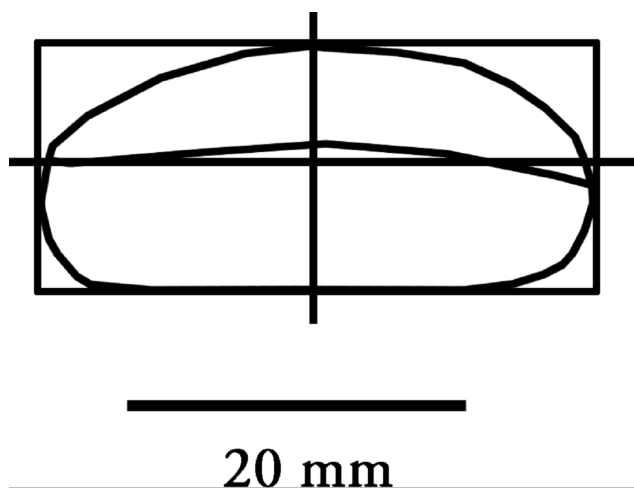
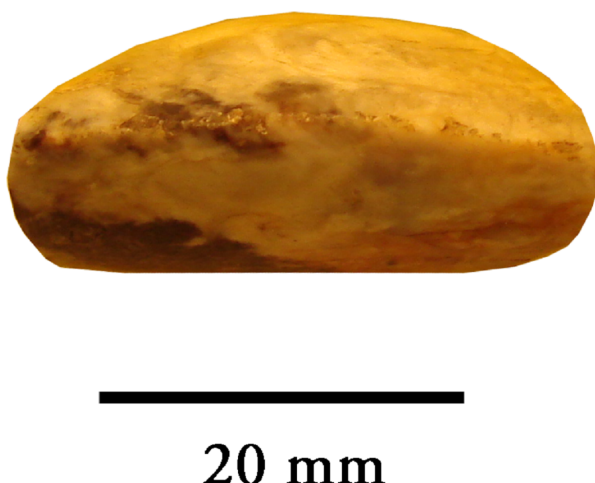

Reference: DSB 2003

Characteristics of the polished axe:

Length: 140,00

Edge width: 56,00

Archaeological site: Dehesa de San Bartolomé

Characteristics of the edge:

Amp1: 0,00

Amp2: 0,00

Type of edge: D

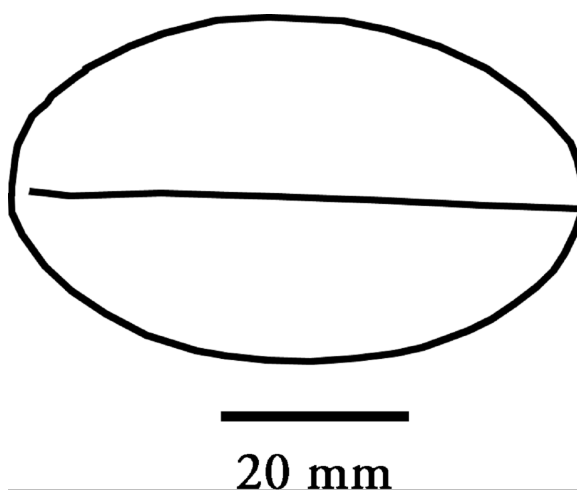
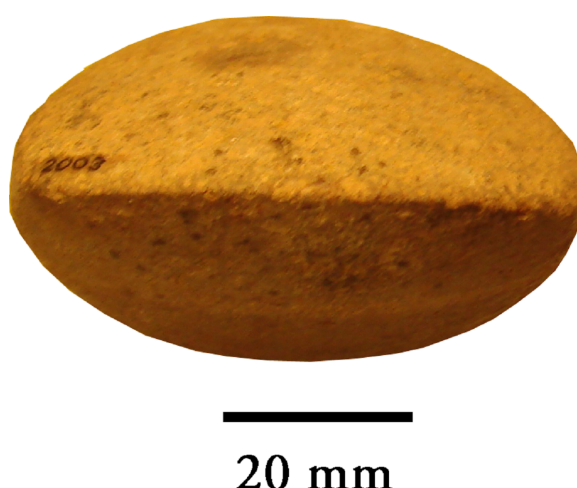

Reference: 2016 DSB (corte 1)

Characteristics of the polished axe:

Length: 121,00

Edge width: 30,00

Archaeological site: Dehesa de San Bartolomé

Characteristics of the edge:

Amp1: 1,37

Amp2: -1,38

Type of edge: R

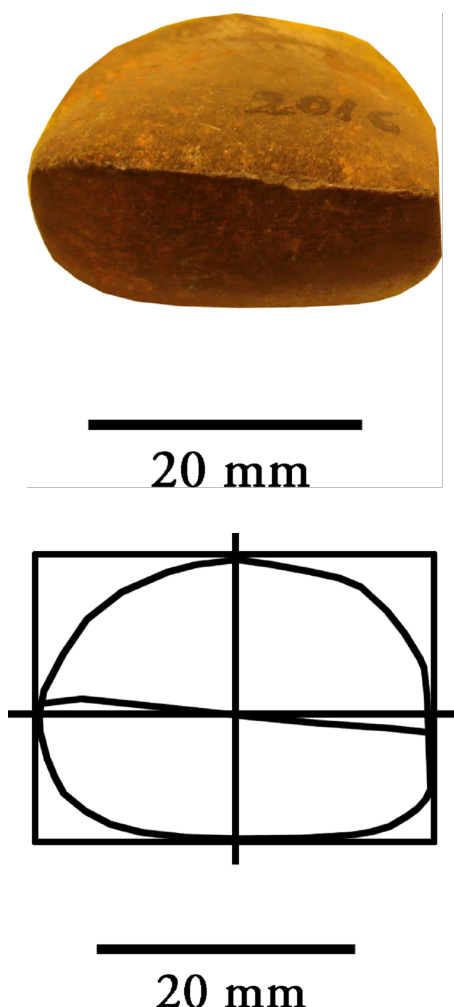

Reference: 2010 DSB

Characteristics of the polished axe:

Length: 110,00

Edge width: 25,00

Archaeological site: Dehesa de San Bartolomé

Characteristics of the edge:

Amp1: 1,07

Amp2: -1,52

Type of edge: R

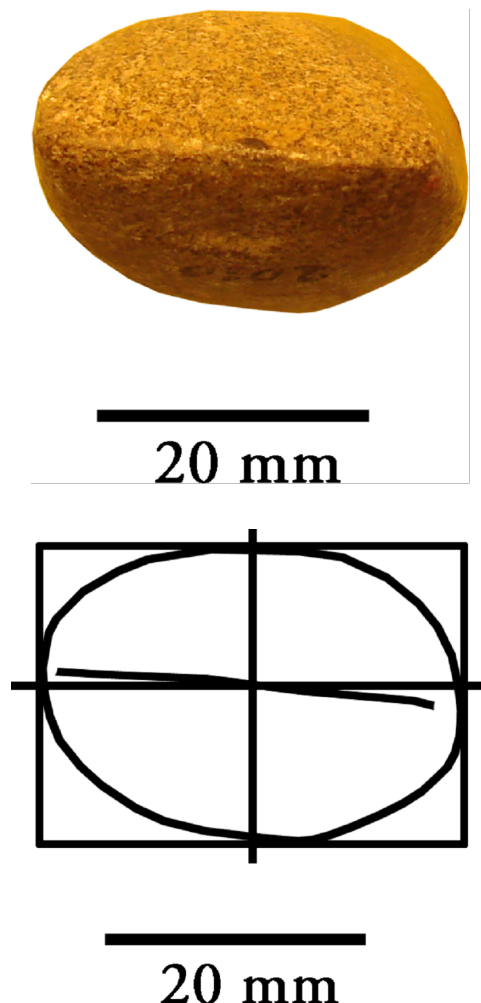

Reference: 2014 DSB

Characteristics of the polished axe:

Length: (74,00)

Edge width: 60,00

Archaeological site: Dehesa de San Bartolomé

Characteristics of the edge:

Amp1: 0,00

Amp2: 0,00

Type of edge: D

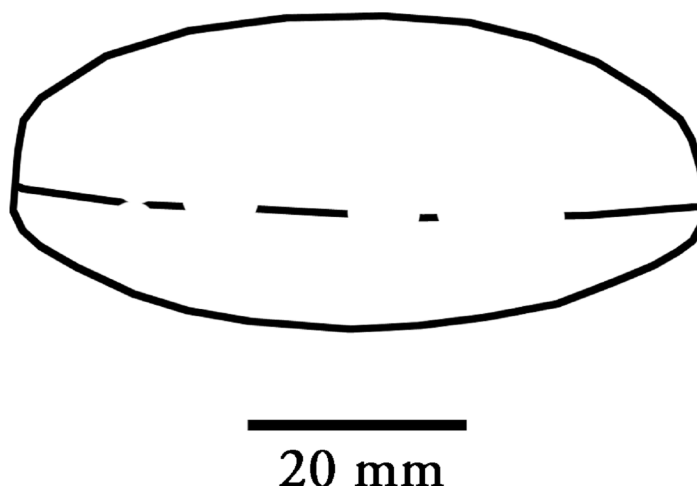

Reference: 2011 DSB

Characteristics of the polished axe:

Length: 132,00

Edge width: 40,00

Archaeological site: Dehesa de San Bartolomé

Characteristics of the edge:

Amp1: 0,00

Amp2: 0,00

Type of edge: D

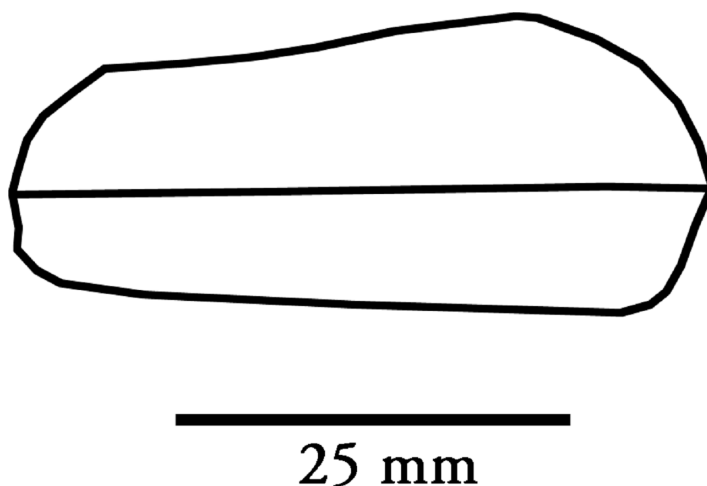
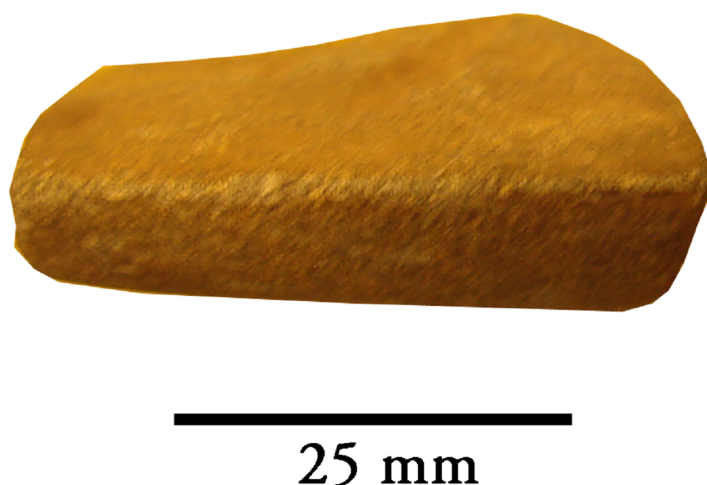

Reference: Zumelzu 9/11/87

Characteristics of the polished axe:

Length: 96,00

Edge width: 55,00

Archaeological site: Zumeltzu

Characteristics of the edge:

Amp1: 0,00

Amp2: 0,00

Type of edge: D

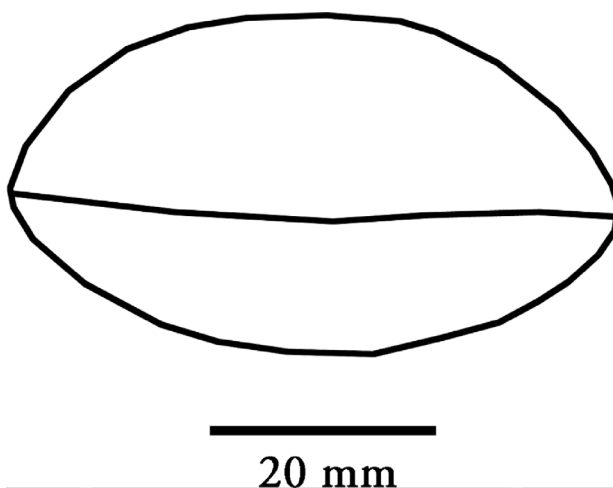

## Reference: El Espinal

### Characteristics of the polished axe:

Length: (83,00)

Edge width: 67,00

Archaeological site: El Espinal

### Characteristics of the edge:

Amp1: 0,00

Amp2: 0,00

Type of edge: D

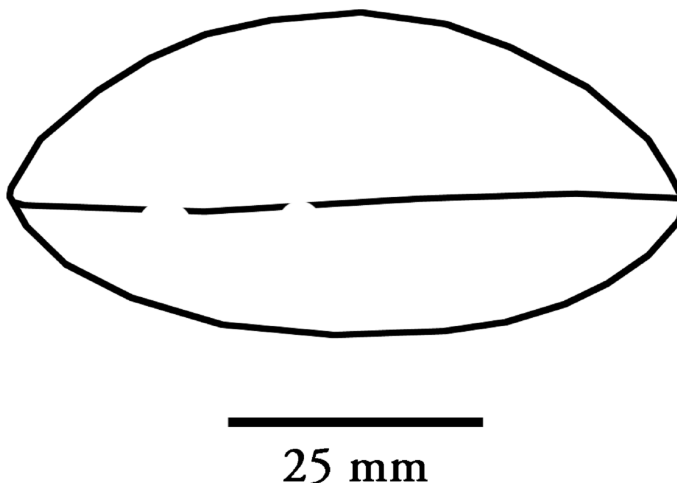
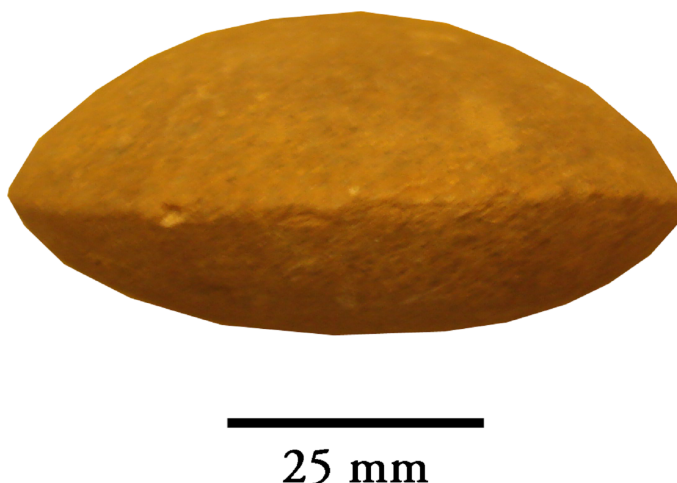



Reference: Miz 324

Characteristics of the polished axe:

Length: 68,00

Edge width: 43,00

Archaeological site: Mizkiartes

Characteristics of the edge:

Amp1: -3,08

Amp2: 1,95

Type of edge: L



20 mm

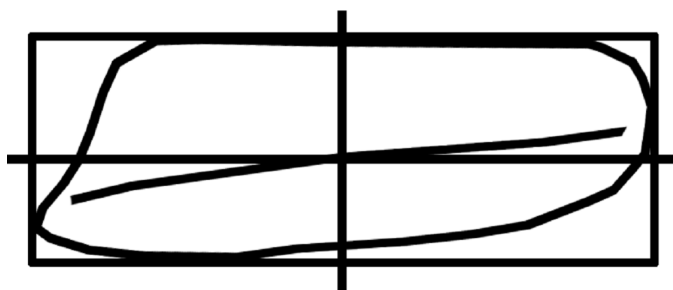

20 mm

Reference: 2016 DSB (corte 2)

Characteristics of the polished axe:

Length: 121,00

Edge width: 20,00

Archaeological site: Dehesa de San Bartolomé

Characteristics of the edge:

Amp1: 0,52

Amp2: -0,45

Type of edge: R

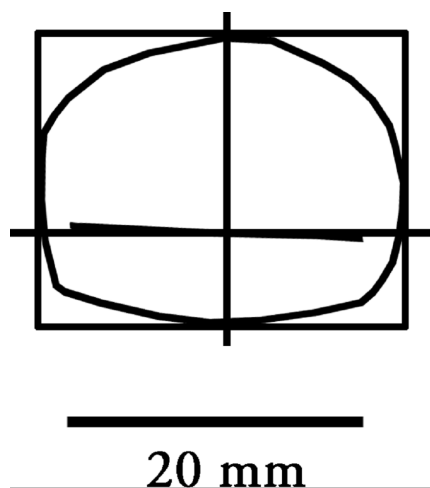

Reference: 81/2264

Characteristics of the polished axe:

Length: (77)

Edge width: 51

Archaeological site: Larraskitu

Characteristics of the edge:

Amp1: 3,77

Amp2: -1,02

Type of edge: R



20 mm

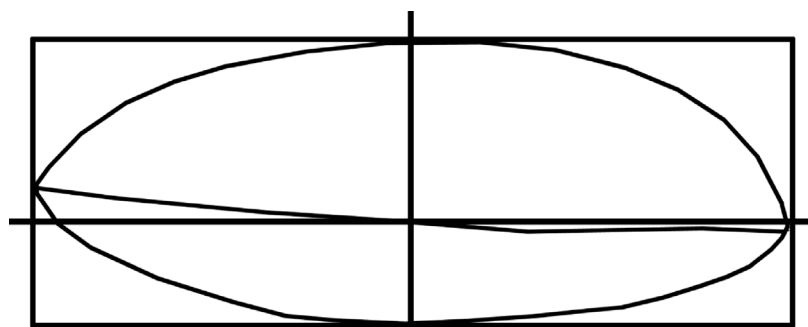

20 mm

Reference: LC II 88-II-8

Characteristics of the polished axe:

Length: 65

Edge width: 45

Archaeological site: Lacilla II

Characteristics of the edge:

Amp1: 0,00

Amp2: 0,00

Type of edge: D



15 mm

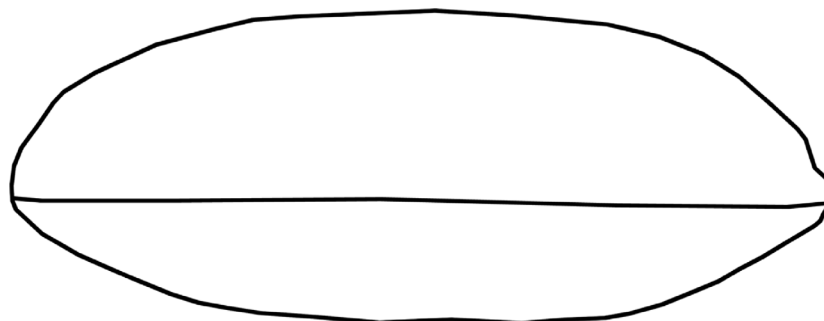

15 mm

Reference: 3062

Characteristics of the polished axe:

Length: 123

Edge width: 61

Archaeological site: Berreaga

Characteristics of the edge:

Amp1: 0,00

Amp2: 0,00

Type of edge: D

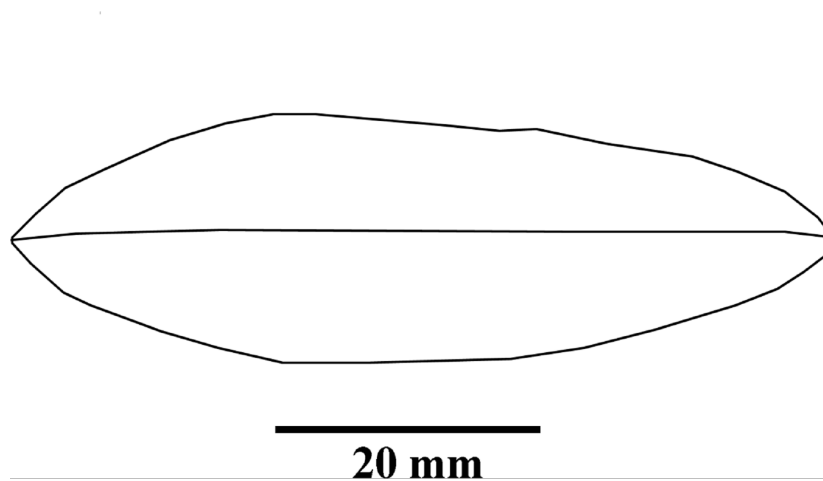
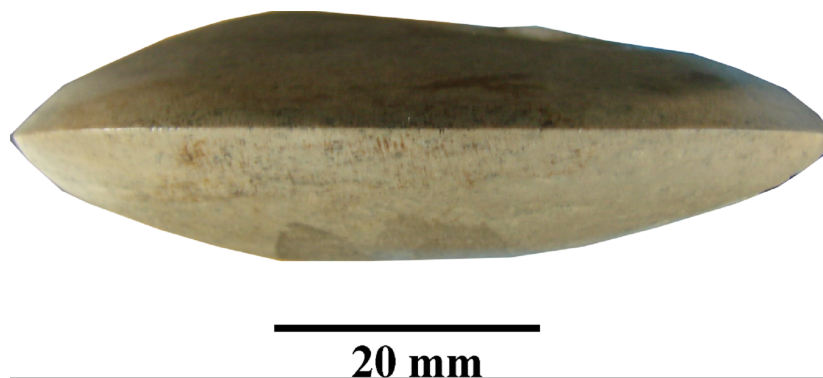

Reference: 1420

Characteristics of the polished axe:

Length: 260

Edge width: 61

Archaeological site: Dima

Characteristics of the edge:

Amp1: 0,00

Amp2: 0,00

Type of edge: D

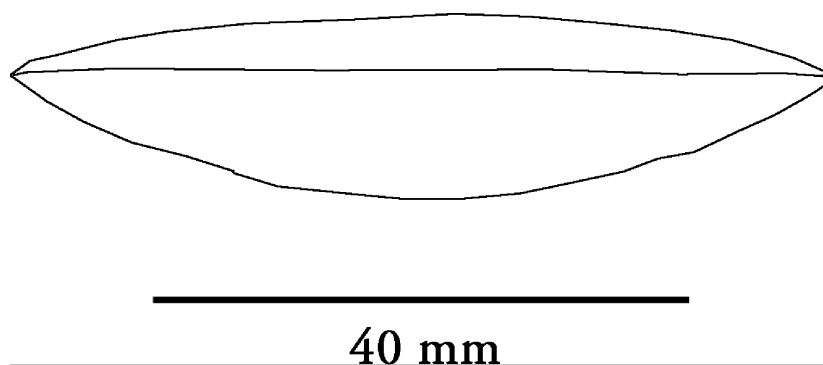
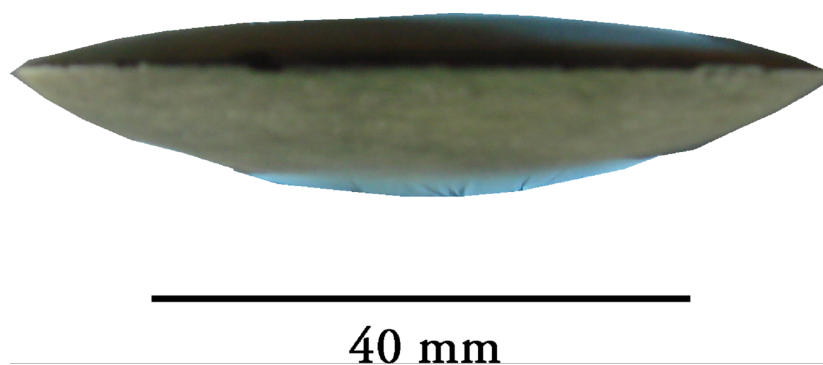

Reference: LCII.88.I.1

Characteristics of the polished axe:

Length: 71

Edge width: 41

Archaeological site: Lacilla II

Characteristics of the edge:

Amp1: 0,00

Amp2: 0,00

Type of edge: D

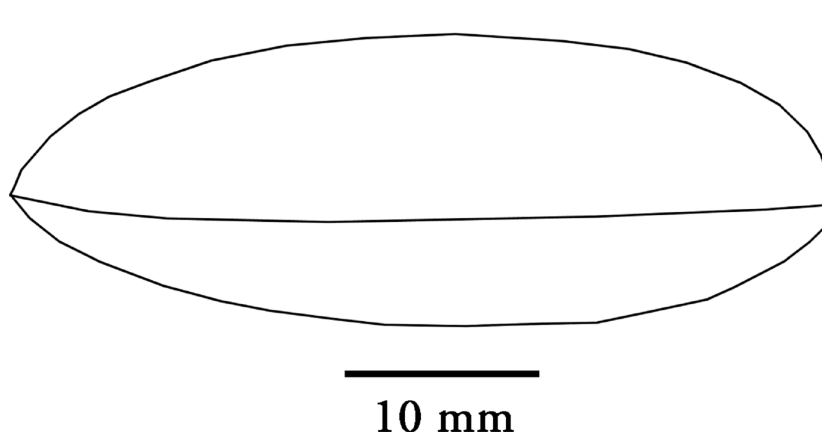

Reference: LCII.88.II.6

Characteristics of the polished axe:

Length: 77

Edge width: (36)

Archaeological site: Lacilla II

Characteristics of the edge:

Amp1: 2,30

Amp2: 0,00

Type of edge: R



15 mm

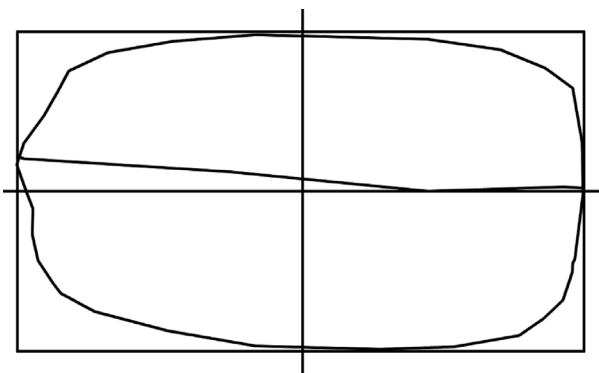

15 mm



Reference: LCII.88.II.3

Characteristics of the polished axe:

Length: 60

Edge width: (27)

Archaeological site: Lacilla II

Characteristics of the edge:

Amp1: -2,05

Amp2: 1,74

Type of edge: L



15 mm

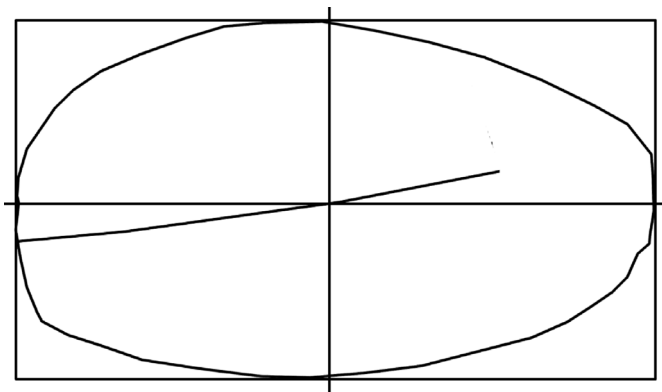

15 mm

Reference: LCII.88.I.4

Characteristics of the polished axe:

Length: 65

Edge width: 40

Archaeological site: Lacilla II

Characteristics of the edge:

Amp1: 0,76

Amp2: -1,25

Type of edge: R



20 mm

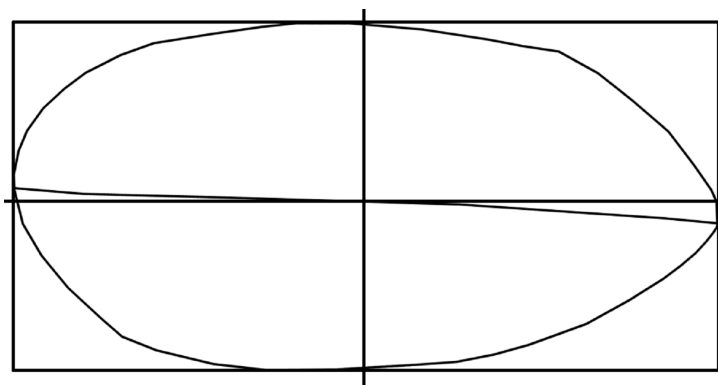

20 mm

Reference: LCII.88.II.9

Characteristics of the polished axe:

Length: 44

Edge width: 35

Archaeological site: Lacilla II

Characteristics of the edge:

Amp1: 0,82

Amp2: -0,54

Type of edge: R



15 mm

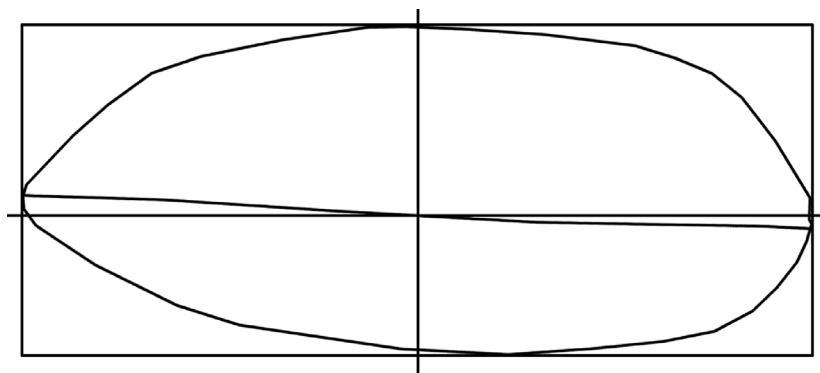

15 mm

Reference: PRA-B4-520

Characteristics of the polished axe:

Length: (81)

Edge width: 47

Archaeological site: Pico Ramos

Characteristics of the edge:

Amp1: 3,99                      Amp2: -0,78

Type of edge: R



20 mm

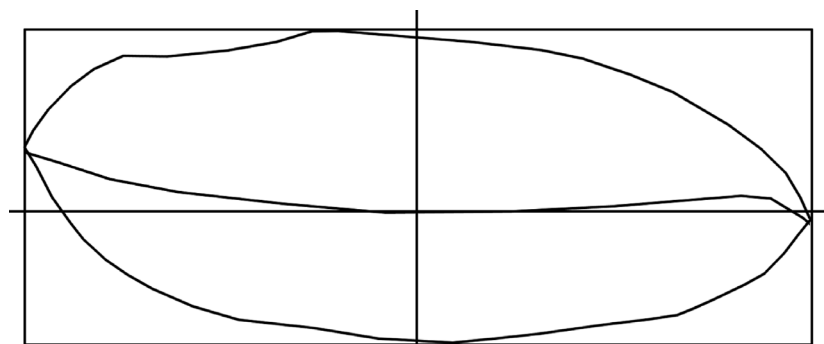

20 mm

Reference: PRA-B5-524

Characteristics of the polished axe:

Length: 46

Edge width: 39

Archaeological site: Pico Ramos

Characteristics of the edge:

Amp1: 0,95                  Amp2: -1,00

Type of edge: R



15 mm

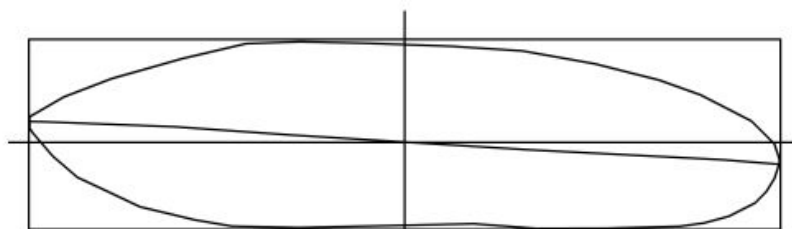

15 mm

Reference: PRA-B7-743

Characteristics of the polished axe:

Length: (27)

Edge width: 55

Archaeological site: Pico Ramos

Characteristics of the edge:

Amp1: 0,00                  Amp2: 0,00

Type of edge: D



20 mm

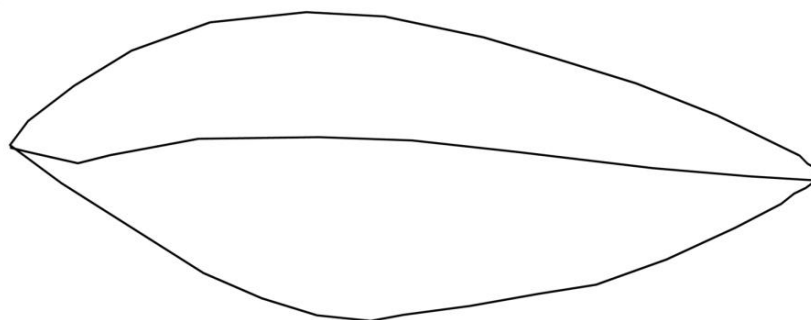

20 mm

Reference: PRA-B4-521

Characteristics of the polished axe:

Length: 74

Edge width: 19

Archaeological site: Pico Ramos

Characteristics of the edge:

Amp1: 0,00

Amp2: 0,00

Type of edge: D



20 mm

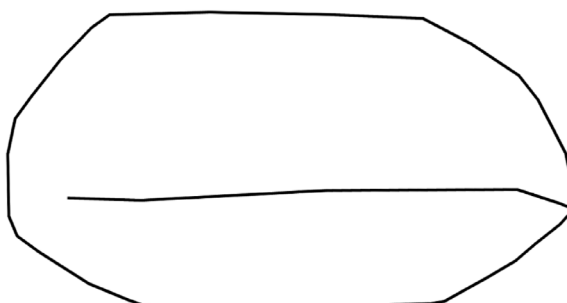

20 mm

Reference: PRA-C4-160

Characteristics of the polished axe:

Length: 61

Edge width: 46

Archaeological site: Pico Ramos

Characteristics of the edge:

Amp1: 0,00

Amp2: 0,00

Type of edge: D



15 mm

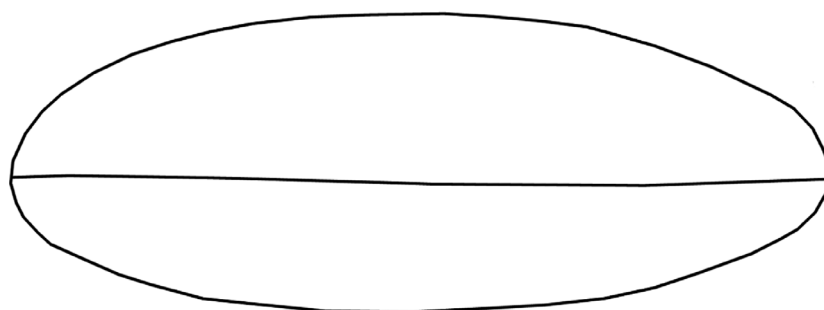

15 mm



Reference: PRA-B5.161

Characteristics of the polished axe:

Length: 74

Edge width: 25

Archaeological site: Pico Ramos

Characteristics of the edge:

Amp1: 0,45

Amp2: 0,37

Type of edge: R

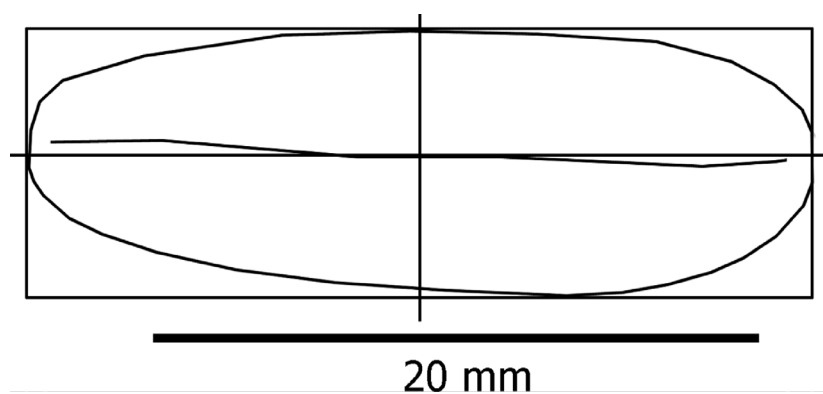
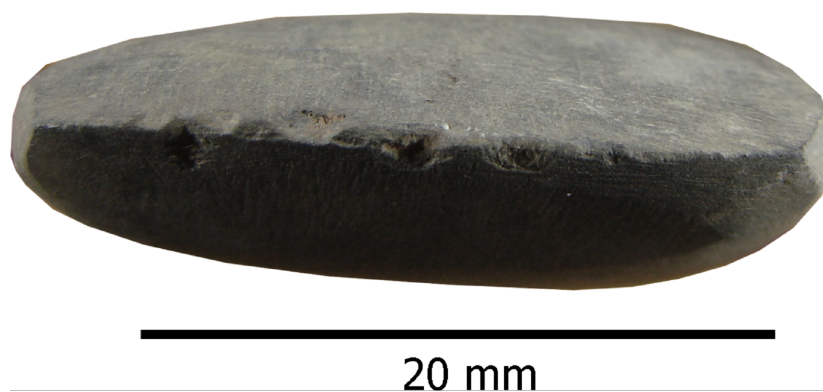

Reference: PRA-B6-522

Characteristics of the polished axe:

Length: (61)

Edge width: 38

Archaeological site: Pico Ramos

Characteristics of the edge:

Amp1: -1,36

Amp2: 1,17

Type of edge: L

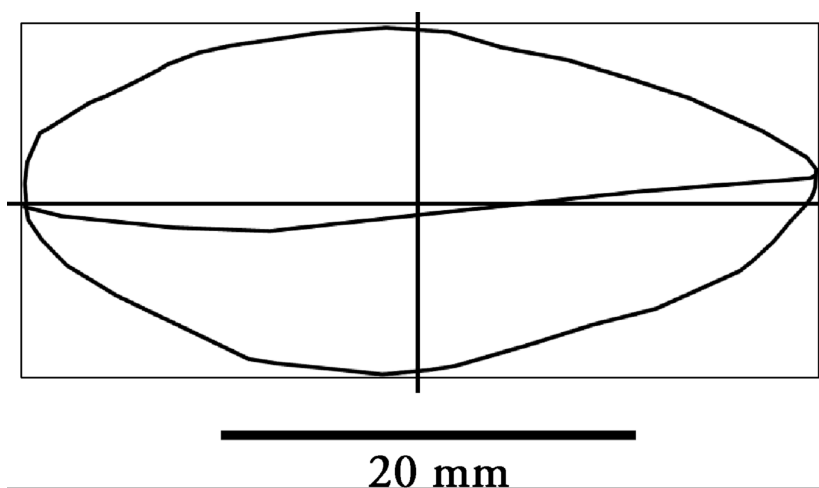
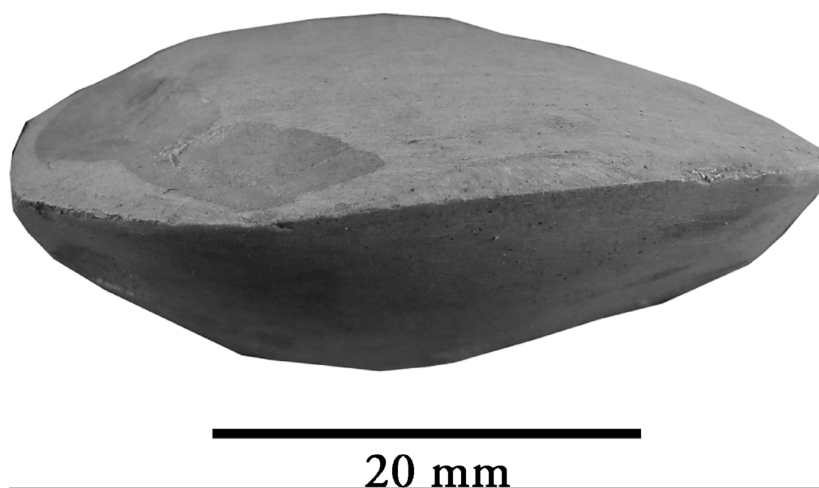

Reference: PRA-C5-159

Characteristics of the polished axe:

Length: 57

Edge width: 31

Archaeological site: Pico Ramos

Characteristics of the edge:

Amp1: 0,00

Amp2: 0,00

Type of edge: D

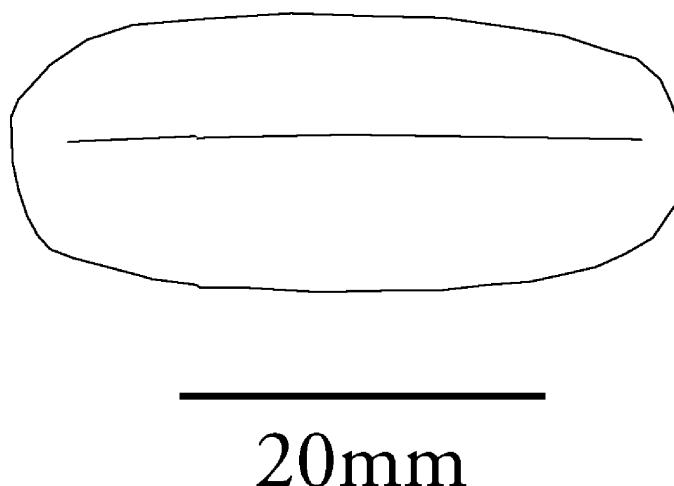

Reference: PRA-B5-523

Characteristics of the polished axe:

Length: 41

Edge width: 38

Archaeological site: Pico Ramos

Characteristics of the edge:

Amp1: 0,00

Amp2: 0,00

Type of edge: D

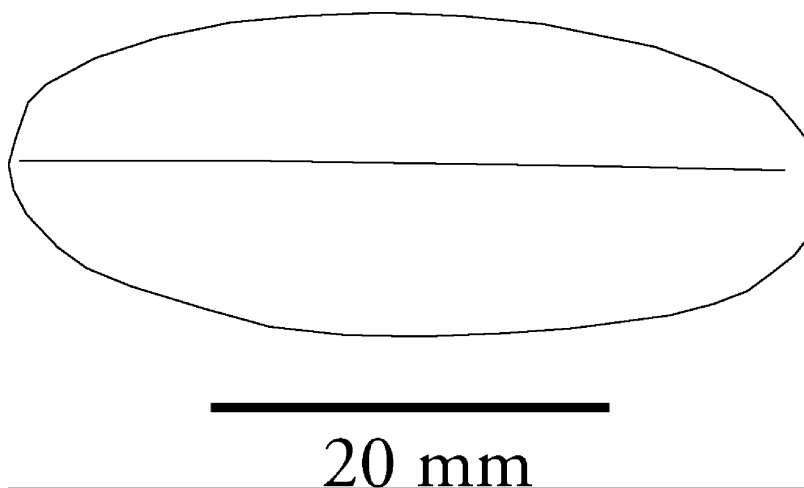
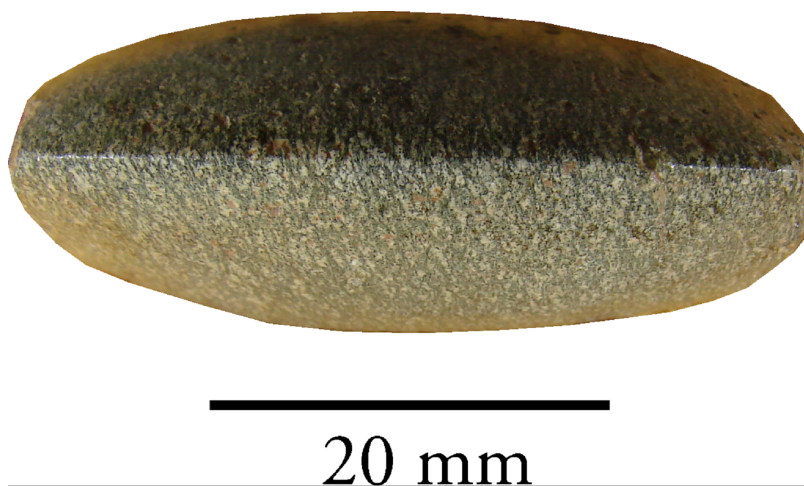

Reference: PRA-B5-162

Characteristics of the polished axe:

Length: 70

Edge width: 43

Archaeological site: Pico Ramos

Characteristics of the edge:

Amp1: 0,00

Amp2: 0,00

Type of edge: D



20 mm



20 mm

Reference: 90/4562

Characteristics of the polished axe:

Length: 110

Edge width: 39

Archaeological site: Ajangiz

Characteristics of the edge:

Amp1: 0,00

Amp2: 0,00

Type of edge: D



40 mm

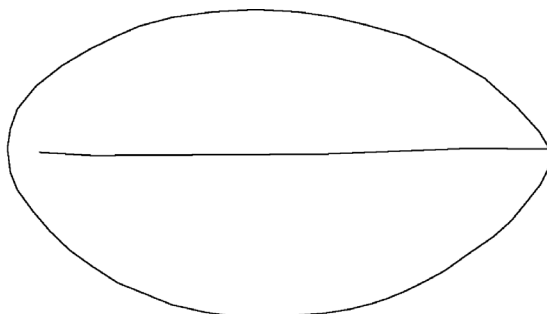

40 mm

## Reference: HR2-22

### Characteristics of the polished axe:

Length: 240

Edge width: 57

Archaeological site: Hirimugarrieta II

### Characteristics of the edge:

Amp1: 5,59

Amp2: -2,52

Type of edge: R



20 mm

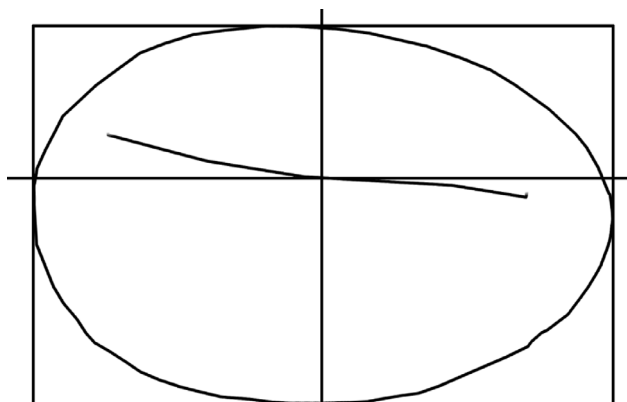

20 mm

Reference: 1-18.01.05/27

Characteristics of the polished axe:

Length: 57

Edge width: 45

Archaeological site: Los Zorros

Characteristics of the edge:

Amp1: 0,00

Amp2: 0,00

Type of edge: D



40 mm

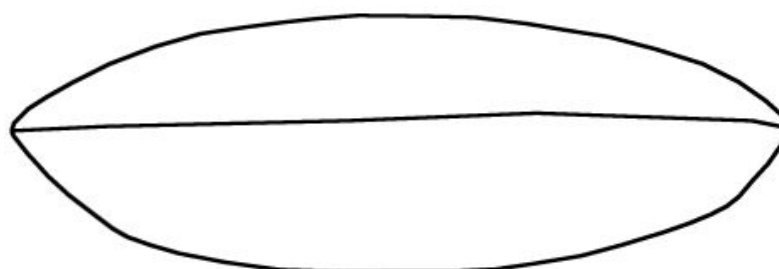

40 mm



Reference: 90/2241

Characteristics of the polished axe:

Length: 155

Edge width: 47

Archaeological site: Maieskune

Characteristics of the edge:

Amp1:

Amp2:

Type of edge: D



---

50 mm

---

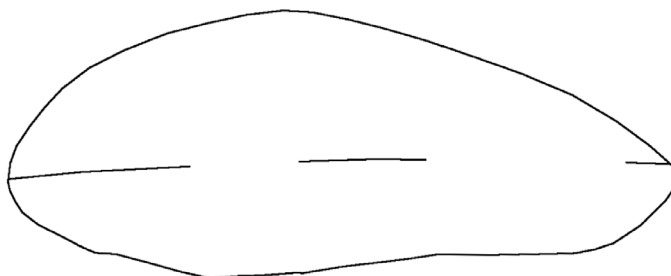

---

50 mm

---

Reference: 1-20.01.05/29

Characteristics of the polished axe:

Length: 97

Edge width: 33

Archaeological site: Ollagorta

Characteristics of the edge:

Amp1:

Amp2:

Type of edge: D

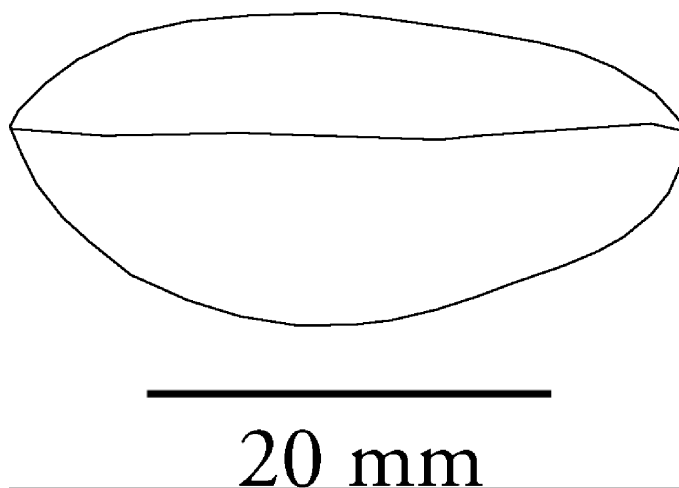

Reference: 1-20.02.03707

Characteristics of the polished axe:

Length: (175)

Edge width: 47

Archaeological site: Galupa I

Characteristics of the edge:

Amp1: 1,81

Amp2: -1,76

Type of edge: L

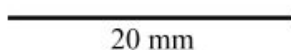
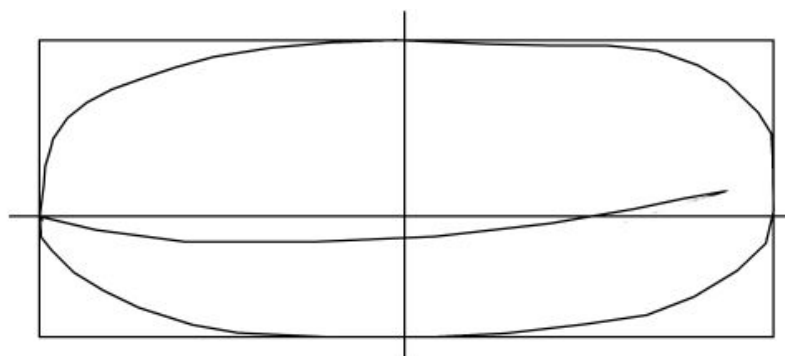
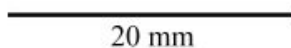

Reference: KB-9A.135.5

Characteristics of the polished axe:

Length: (85)

Edge width: 54

Archaeological site: Kobeaga I

Characteristics of the edge:

Amp1: 0,00

Amp2: 0,00

Type of edge: D



20 mm

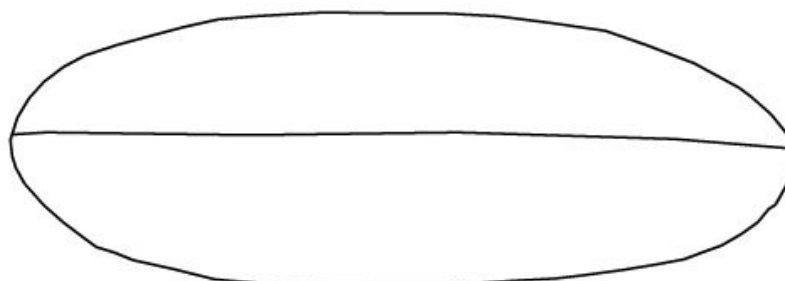

20 mm

## Reference: BER-superficial-36

### Characteristics of the polished axe:

Length: 170

Edge width: 39

Archaeological site: Berreaga

### Characteristics of the edge:

Amp1: -1,33

Amp2: 2,67

Type of edge: L

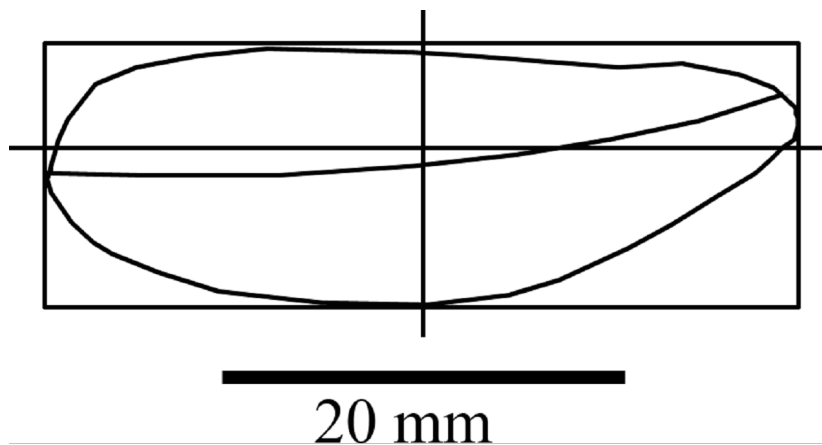

Reference: BZ-8346

Characteristics of the polished axe:

Length: 84

Edge width: 32

Archaeological site: Baltzola

Characteristics of the edge:

Amp1: 0,00

Amp2: 0,00

Type of edge: D

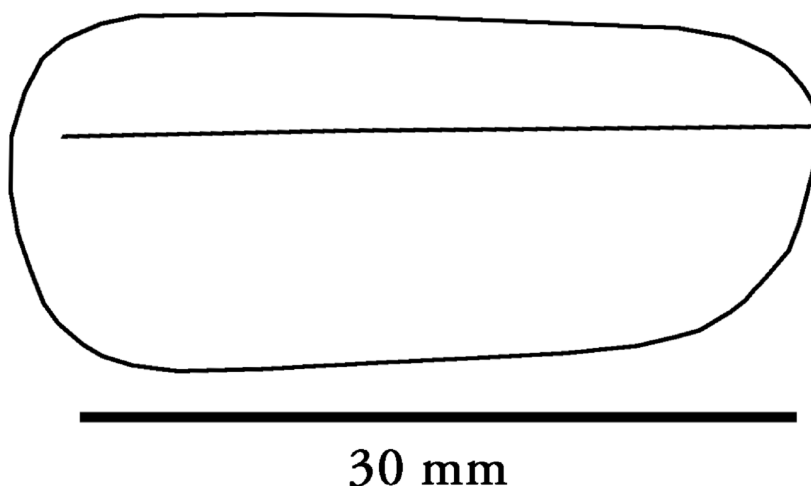
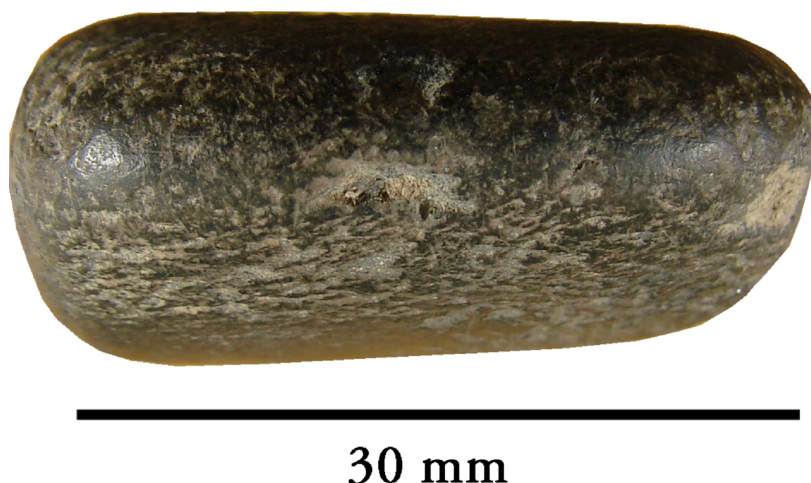

Reference: 1-13.02.08/03

Characteristics of the polished axe:

Length: (45)

Edge width: 24

Archaeological site: Ereñuko Arizti II

Characteristics of the edge:

Amp1: -0,94

Amp2: 0,76

Type of edge: L



20 mm

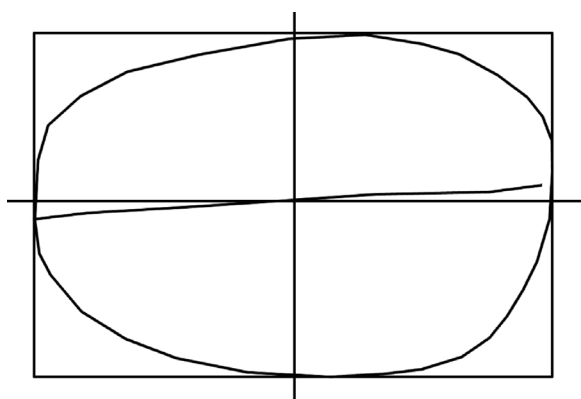

20 mm

Reference: 81/2914-2

Characteristics of the polished axe:

Length: (66)

Edge width: 57

Archaeological site: Baltzola

Characteristics of the edge:

Amp1: 0,00                  Amp2: 0,00

Type of edge: D



20 mm

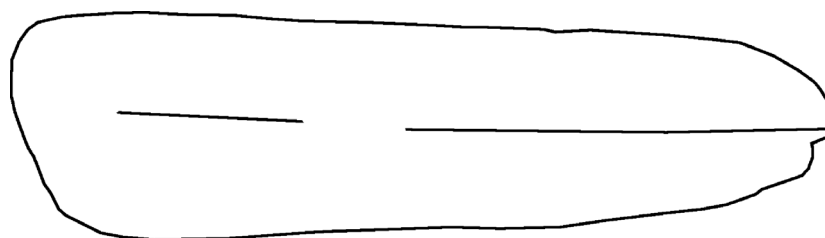

20 mm



Reference: 81/2914-1

Characteristics of the polished axe:

Length: 82

Edge width: 51

Archaeological site: Baltzola

Characteristics of the edge:

Amp1: -2,04                  Amp2: 1,91

Type of edge: L



20 mm

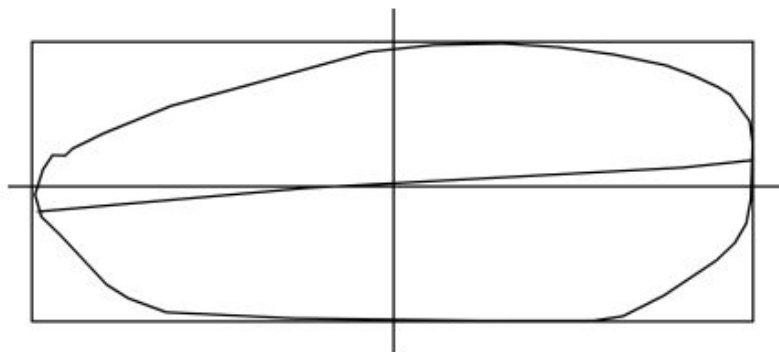

20 mm

Reference: EU-3

Characteristics of the polished axe:

Length: 132

Edge width: 60

Archaeological site: Embalse de Urrunaga

Characteristics of the edge:

Amp1: -0,95                  Amp2: 0,59

Type of edge: L



60 mm

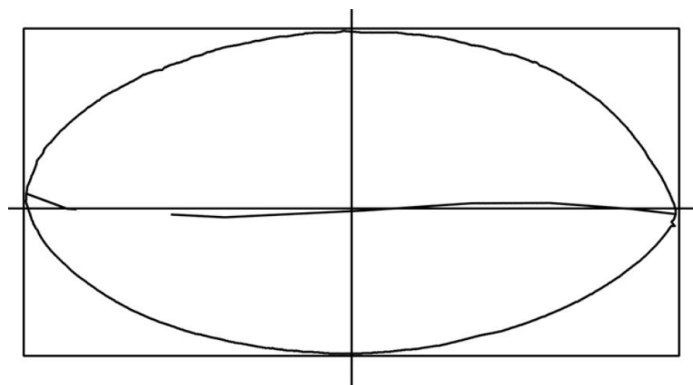

60 mm

## Reference: EU-14

### Characteristics of the polished axe:

Length: 85

Edge width: 49

Archaeological site: Embalse de Urrunaga

### Characteristics of the edge:

Amp1: 1,41

Amp2: -0,79

Type of edge: R



50 mm

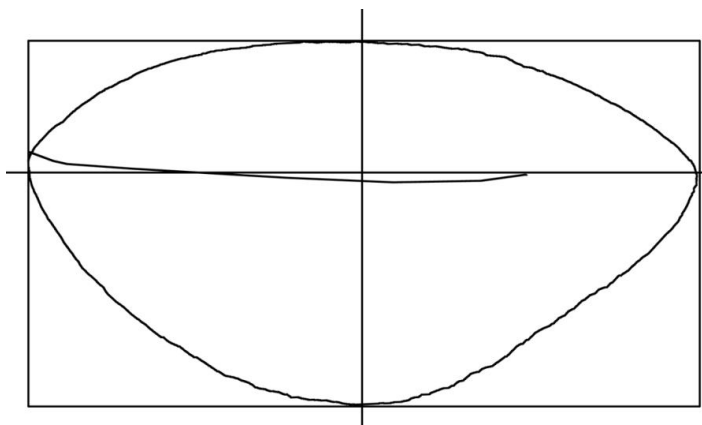

50 mm

Reference: EU-32

Characteristics of the polished axe:

Length: 97

Edge width: 51

Archaeological site: Embalse de Urrunaga

Characteristics of the edge:

Amp1: 1,68                  Amp2: -2,41

Type of edge: R



60 mm

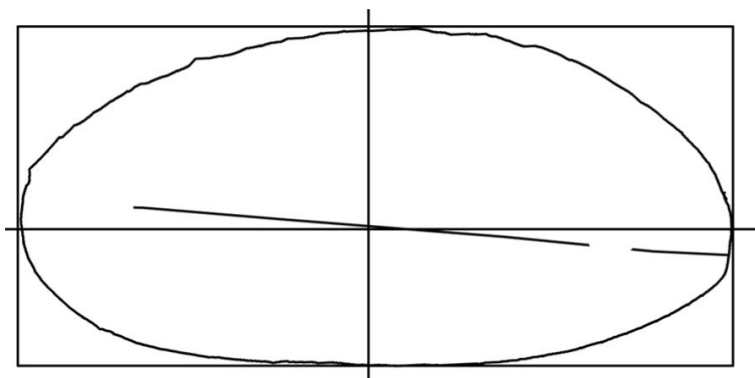

60 mm

# **Anexo II**



Annex II:

Annex II shows the details of each archaeological flake, as well as the photographs of some of the flakes with the orientations of the axes of symmetry of each of the parabolic crack.

Each archaeological flake has been listed in a table where its reference is detailed. All measurements of length, width and thickness are taken in millimeters and the orientation of the different parabolic cracks that appear in each flake (PC1, PC2, PC3, PC4 and PC5) are measured in sexagesimal degrees.

In the photographs the platform of each flake have been represented and the axes of symmetry of the parabolic cracks present in each case have been drawn.

Reference	Site	Level	Length	Width	Maximum thickness	Platform width	Platform type	PC1	PC2	PC3	PC4	PC5	PC type
AX.9B.245.4	Axlor	III	18	27	5	27	Dihedral	16					R
AX.11B.310.18	Axlor	III	16	39	9	23	Plain	-14					L
AX.7B.245.25. AL 29	Axlor	III	11	17	4	11	Plain	28	16				R
AX.9B.250.2	Axlor	III	24	30	7	16	Plain	-14	-7				L
AX.5B.250.45 AL 93	Axlor	III	26	13	5	9	Plain	13					R
AX.5B.250	Axlor	III	14	19	5	9	Plain	39					R
AX.13C.245.1	Axlor	III	30	27	8	18	Plain	44					R
AX.9C.250.19 AL 34	Axlor	III	12	15	3	10	Plain	13	11				R
AX.5C.250.1	Axlor	III	19	17	7	14	Plain	59	12				R
AX.5C.250	Axlor	III	20	14	5	8	Plain	-43					L
AX.5C.250	Axlor	III	10	17	5	15	Plain	12					R
AX.9D.240.6 AL10	Axlor	III	11	17	3	12	Plain	72	15				R
AX.15D.250.8	Axlor	III	30	42	17	27	Plain	19					R
AX.15D.250.14	Axlor	III	27	17	6	16	Faceted	-51					L
AX.15D.250.20 AL32	Axlor	III	18	19	9	9	Plain	62					R
AX.5D.250.106	Axlor	III	22	22	7	7	Plain	17					R
AX.5D.250.105	Axlor	III	31	17	6	15	Plain	-56					L
AX.5D.250.110	Axlor	III	23	27	10	24	Plain	-50					L
AX.5D.250.265	Axlor	III	13	13	5	9	Plain	29					R
AX.5D.250.134 AL 262	Axlor	III	19	22	4	9	Plain	26					R
AX.5D.250.134 AL 262	Axlor	III	16	20	6	17	Plain	10	-2				R
AX.5D.250.134 AL 262	Axlor	III	23	17	7	7	Plain	-59	-46	-16			L
AX.5D.250.134 AL 262	Axlor	III	23	22	8	17	Plain	33					R
AX.5D.250.6	Axlor	III	27	36	11	33	Plain	45	20				R
AX.5D.250.18	Axlor	III	36	21	6	19	Faceted	67					R
AX.5D.250.19	Axlor	III	26	19	7	14	Plain	35					R
AX.5D.250.31	Axlor	III	29	29	13	29	Faceted	43					R
AX.9E.250.20	Axlor	III	21	36	9	21	Faceted	50	15	14	-1		R
AX.9E.250.4	Axlor	III	28	25	7	17	Plain	29					R
AX.9E.250.18	Axlor	III	24	27	8	16	Plain	15	-5				R
AX.5E.250.148 AL 233	Axlor	III	27	21	28	15	Plain	54	29	20	8		R
AX.5E.250.45	Axlor	III	32	41	12	30	Plain	42	13				R
AX.5E.250.85	Axlor	III	38	27	12	11	Plain	16					R
AX.5E.250.23	Axlor	III	16	35	10	21	Plain	-34	-14	2			L
AX.5E.250.55	Axlor	III	24	25	7	21	Faceted	-89	-30				L
AX.5E.250.9	Axlor	III	19	35	8	21	Plain	-26					L
AX.5E.250.8	Axlor	III	13	36	10	36	Plain	19					R
AX.5E.250.27	Axlor	III	17	32	9	32	Dihedral	41					R
AX.5E.250.82	Axlor	III	27	26	15	12	Plain	20	18	16	11		R



Anexo II

AX.5E.250.52	Axlor	III	24	22	13	12	Plain	73					R
AX.7E.250.23 AL45	Axlor	III	17	24	5	13	Plain	63					R
AX.5E.250.3	Axlor	III	25	33	7	23	Plain	50	18	16			R
AX.5E.250.13	Axlor	III	32	31	12	31	Faceted	69	56				R
AX.5E.250.32	Axlor	III	27	40	8	23	Plain	61					R
AX.IV.268.1	Axlor	IV	26	26	12	19	Dihedral	-10					L
AX.IV.271.3	Axlor	IV	31	21	9	9	Plain	55					R
AX.5B.273.8	Axlor	IV	34	44	17	31	Faceted	27	26				R
AX.5B.285.13 AL68	Axlor	IV	14	28	10	11	Plain	25					R
AX.5B.255.8	Axlor	IV	15	34	7	21	Faceted	10					R
AX.5B.265.7	Axlor	IV	50	34	16	30	Plain	-47	-36	-31	-23		L
AX.5B.265.8	Axlor	IV	37	27	11	19	Plain	-54					L
AX.5B.272.43	Axlor	IV	30	21	12	19	Faceted	27					R
AX.5B.265.4	Axlor	IV	24	25	8	17	Plain	-21					L
AX.5B.265-275.46	Axlor	IV	19	27	6	18	Plain	-16					L
AX.5B.278.7	Axlor	IV	29	25	9	17	Plain	68					R
AX.5B.278.0	Axlor	IV	33	22	12	22	Plain	38	9	6			R
AX.7B.285.3	Axlor	IV	16	36	11	23	Plain	22					R
AX.7B.294.24	Axlor	IV	21	20	14	15	Plain	17					R
AX.7B.294.82 AL 132	Axlor	IV	23	20	7	14	Plain	-25					L
AX.7B.260.4	Axlor	IV	23	27	10	25	Plain	20					R
AX.7B.275.26	Axlor	IV	41	34	11	26	Plain	51					R
AX.7B.275.2	Axlor	IV	29	27	15	25	Plain	36					R
AX.7B.275.107 AL 169	Axlor	IV	10	27	6	17	Plain	11					R
AX.7B.275.60 AL 77	Axlor	IV	19	13	6	12	Plain	37					R
AX.7B.281.168.168 AL232	Axlor	IV	21	28	9	28	Plain	45					R
AX.7B.270.10	Axlor	IV	34	55	13	30	Plain	64	61	57			R
AX.7B.270.22	Axlor	IV	22	28	10	10	Plain	-30					L
AX.7B.270.29	Axlor	IV	20	25	8	22	Plain	66					R
AX.9B.297.8	Axlor	IV	25	30	12	30	Plain	57					R
AX.9B.260.2	Axlor	IV	31	19	9	13	Plain	-27					L
AX.9B.265.2	Axlor	IV	20	42	13	24	Plain	59					R
AX.9B.297-300.2	Axlor	IV	26	19	14	19	Plain	-30					L
AX.9B.280.6	Axlor	IV	23	21	11	16	Plain	28					R
AX.9B.293.18	Axlor	IV	15	21	8	18	Plain	-10					L
AX.9B.293.5	Axlor	IV	21	28	9	18	Plain	76	52				R
AX.5C.669.13	Axlor	IV	29	31	11	31	Plain	64	61	15	9		R
AX.5C.279.4	Axlor	IV	25	39	17	21	Plain	11	2				R
AX.5C.297.1	Axlor	IV	18	37	13	22	Plain	-52	-32				L
AX.5C.271.22	Axlor	IV	26	39	9	34	Plain	65					R
AX.5C.265-275.22	Axlor	IV	20	30	18	14	Plain	12					R
AX.5C.265-275.160 AL 237	Axlor	IV	21	24	18	14	Plain	81					R
AX.5C.265-275.160 AL 237	Axlor	IV	21	20	5	18	Plain	-14					L
AX.5C.289.17	Axlor	IV	58	31	9	17	Plain	73					R
AX.5C.289.18 AL 48	Axlor	IV	22	19	5	11	Plain	70	56	12	-1		R

*Evaluación arqueológica del proceso de lateralización*

AX.5C.289.18 AL 48	Axlor	IV	26	22	7	14	Plain	-15					L
AX.5C.275.15	Axlor	IV	13	35	11	23	Plain	14	11				R
AX.5C.275.55 AL 178	Axlor	IV	21	16	6	14	Plain	32					R
AX.5C.275.55 AL 178	Axlor	IV	17	23	5	10	Plain	61					R
AX.7C.293.18	Axlor	IV	43	32	15	32	Plain	16					R
AX.7C.260.71 AL 89	Axlor	IV	15	26	9	19	Plain	81	48	44			R
AX.7C.260.6	Axlor	IV	38	28	14	15	Faceted	-39					L
AX.7C.260.1	Axlor	IV	29	25	7	22	Faceted	13					R
AX.7C.265.38 AL 95	Axlor	IV	17	19	9	16	Plain	-33					L
AX.7C.265.19	Axlor	IV	27	36	12	20	Plain	63	34				R
AX.7C.290.260 AL 351	Axlor	IV	20	32	10	27	Faceted	-64	-30				L
AX.7C.296.38 AL 92	Axlor	IV	22	19	7	11	Plain	46					R
AX.7C.270.41	Axlor	IV	26	23	10	13	Plain	59					R
AX.7C.270.15	Axlor	IV	23	30	13	9	Plain	48					R
AX.7C.275.59 AL 139	Axlor	IV	21	19	17	16	Plain	10					R
AX.7C.275.3	Axlor	IV	26	33	16	29	Plain	45					R
AX.7C.280.50	Axlor	IV	24	28	9	22	Plain	62	22				R
AX.9C.289.2	Axlor	IV	25	30	10	30	Faceted	27					R
Ax.9C.285.25	Axlor	IV	23	26	9	25	Plain	77					R
AX.9C.290.26	Axlor	IV	16	32	14	23	Plain	55	54				R
AX.9C.280.26 AL42	Axlor	IV	12	23	6	14	Faceted	54					R
AX.9C.296.23	Axlor	IV	26	28	8	28	Faceted	16					R
AX.9C.296.3	Axlor	IV	27	21	13	21	Plain	15	-8				R
AX.9C.288.13	Axlor	IV	15	19	6	12	Plain	57					R
AX.11C.280.398 AL 426	Axlor	IV	21	19	8	19	Plain	-10					L
AX.11C.290.6 AL 35	Axlor	IV	16	27	5	17	Plain	20					R
AX.11C.290.3	Axlor	IV	27	27	7	23	Dihedral	-34	-32				L
AX.5D.276.19	Axlor	IV	31	31	13	13	Plain	-15					L
AX.5D.265-275.39	Axlor	IV	14	18	9	11	Plain	-28					L
AX.5D.273.8	Axlor	IV	27	26	10	26	Faceted	-15					L
AX.5D.270.10	Axlor	IV	47	34	15	34	Dihedral	-23	-15				L
AX.7E.278.9	Axlor	IV	29	30	18	27	Faceted	38					R
AX.7D.291.13	Axlor	IV	20	48	15	38	Faceted	42					R
AX.7D.281.26	Axlor	IV	24	37	10	26	Plain	23					R
AX.7D.285.2	Axlor	IV	42	28	13	10	Plain	71					R
AX.7D.288.2	Axlor	IV	29	44	11	16	Faceted	-25					L
AX.7D.270.47	Axlor	IV	48	49	9	16	Faceted	49	9				R
AX.7D.265.58 AL 108	Axlor	IV	15	24	16	15	Plain	-30					L
AX.7D.278.36	Axlor	IV	18	29	5	25	Faceted	52					R
AX.7D.275.46	Axlor	IV	31	24	8	23	Plain	-27					L
AX.9D.288.16	Axlor	IV	19	37	11	30	Plain	61					R
AX.9D.299.3	Axlor	IV	32	53	13	53	Faceted	76					R
AX.9D.260.5	Axlor	IV	19	24	13	21	Plain	-15					L
AX.9D.260.3	Axlor	IV	15	38	11	34	Plain	71					R
AX.9D.284.17	Axlor	IV	11	37	12	37	Plain	62					R

Anexo II

AX.9D.284.19	Axlor	IV	27	21	12	14	Plain	64					R
AX.9D.284.25	Axlor	IV	24	40	11	40	Dihedral	78	66	35			R
AX.9D.265.18 AL 47	Axlor	IV	22	13	5	12	Plain	38					R
AX.9D.265.7	Axlor	IV	33	35	25	24	Plain	63					R
AX.9D.280.18 AL 48	Axlor	IV	20	23	11	19	Plain	54					R
AX.9D.293.9	Axlor	IV	21	34	12	30	Dihedral	-42					L
AX.9D.293.11	Axlor	IV	18	39	9	32	Dihedral	50					R
AX.9D.293.27 AL67	Axlor	IV	21	16	7	11	Plain	25	16				R
AX.9D.293.27 AL67	Axlor	IV	26	32	8	17	Faceted	-17	-11				L
AX.9D.293.27 AL67	Axlor	IV	21	27	6	16	Plain	-11					L
AX.11D.280.60	Axlor	IV	15	26	7	25	Faceted	47					R
AX.5E.271.1	Axlor	IV	46	46	20	43	Faceted	39					R
AX.5E.268.4	Axlor	IV	26	41	11	27	Plain	16	11				R
AX.5E.255.44BIS	Axlor	IV	23	28	8	25	Faceted	-13					L
AX.5E.255.54	Axlor	IV	20	33	12	27	Plain	33					R
AX.7E.265.35	Axlor	IV	15	30	8	21	Plain	-42					L
AX.7E.255.25	Axlor	IV	29	23	10	22	Faceted	-32					L
AX.7E.255.61 AL 106	Axlor	IV	19	33	17	30	Plain	40	23	21	-4	-2	R
AX.7E.270.52	Axlor	IV	27	32	19	32	Faceted	-59					L
AX.7E.280.3	Axlor	IV	36	26	15	19	Plain	-44	-34				L
AX.7E.275.4	Axlor	IV	33	28	13	19	Plain	-14	-3				L
AX.7E.271.34	Axlor	IV	35	25	9	20	Dihedral	13					R
AX.7E.273.2	Axlor	IV	15	22	7	20	Plain	24					R
AX.7E.273.22	Axlor	IV	19	41	6	41	Faceted	44	19				R
AX.7E.273.3	Axlor	IV	19	37	10	28	Plain	82					R
AX.9E.282.1	Axlor	IV	21	53	24	38	Faceted	70	26	21	8		R
AX.9E.270.6	Axlor	IV	17	29	6	21	Faceted	57					R
AX.9E.283.4	Axlor	IV	22	40	13	40	Dihedral	26					R
AX.9E.265.13	Axlor	IV	23	34	10	34	Dihedral	61	39				R
AX.9E.287.10	Axlor	IV	26	41	8	19	Plain	71	22	15			R
AX.9E.287.26 AL 66	Axlor	IV	21	32	11	26	Plain	69	38				R
AX.11E.295.39	Axlor	IV	25	27	7	13	Plain	27					R
AX.11E.280.64 AL 120	Axlor	IV	18	27	14	27	Plain	61	9				R
AX.5E.265.1	Axlor	IV	21	36	8	29	Plain	40	25				R
AX.5E.273.3	Axlor	IV	34	28	10	24	Plain	39					R
AX.5E.255.37	Axlor	IV	23	44	6	22	Plain	-34					L
AX.5E.255.34	Axlor	IV	30	29	11	23	Plain	-28	-25	-21			L
AX.7E.280.2	Axlor	IV	29	23	6	23	Faceted	30					R
AX.7E.265.23	Axlor	IV	19	22	7	20	Faceted	18					R
AX.7E.265.8	Axlor	IV	18	30	9	19	Faceted	51					R
AX.7E.265.9	Axlor	IV	27	39	15	39	Dihedral	47	10	7	-6	-6	R
AX.7E.265.4	Axlor	IV	21	22	9	22	Plain	35					R
AX.7B.306.10	Axlor	V	20	30	9	21	Plain	12					R
AX.9B.313.7	Axlor	V	31	23	11	6	Plain	60					R
AX.9B.330.18	Axlor	V	18	18	6	12	Faceted	31					R

*Evaluación arqueológica del proceso de lateralización*

AX.7C.310.22	Axlor	V	35	27	14	10	Plain	60					R
AX.11C.350.1BIS	Axlor	V	51	31	11	17	Plain	39					R
AX.11C.335.30	Axlor	V	31	23	9	19	Faceted	26					R
AX.11C.335.3	Axlor	V	18	19	7	19	Plain	-26					L
AX.11C.335.21	Axlor	V	27	25	9	10	Plain	39					R
AX.11C.335.8	Axlor	V	23	30	13	17	Plain	60					R
AX.11C.335.11	Axlor	V	35	33	12	17	Plain	-11					L
AX.11C.335.6	Axlor	V	31	24	11	18	Plain	57	39				R
AX.11C.340.10	Axlor	V	16	39	18	31	Plain	25					R
AX.11C.340.7	Axlor	V	26	38	11	30	Plain	28	26				R
AX.11C.320.17	Axlor	V	31	40	15	18	Plain	77					R
AX.11C.330.14	Axlor	V	34	27	12	27	Plain	44					R
AX.11C.330.12	Axlor	V	26	39	15	34	Plain	-44	-42	-42			L
AX.11D.330.14	Axlor	V	32	39	10	28	Plain	23					R
AX.11D.310.13	Axlor	V	26	28	8	15	Faceted	70					R
AX-11D.315.34	Axlor	V	22	29	12	24	Plain	60	-7				R
AX.11D.340.41	Axlor	V	17	27	7	21	Plain	50	25	1			R
AX.11E.330.9	Axlor	V	26	38	15	36	Plain	10					R
AX.11E	Axlor	V	23	32	12	31	Plain	21	15				R
AX.V.1974.107 AL 164	Axlor	V	20	31	9	28	Plain	75	48				R
AX.11F.320.5	Axlor	V	48	42	14	31	Plain	37	37				R
AX.11F.340.28	Axlor	V	36	21	13	17	Plain	20					R
AX.11F.340.12	Axlor	V	28	25	7	25	Dihedral	-28					L
AX.11F.310.17	Axlor	V	23	42	11	38	Faceted	69	24				R
AX.11F.310.8	Axlor	V	19	31	9	31	Plain	29					R
Ax.11F.310.23	Axlor	V	35	23	13	13	Plain	-14					L
AX.11F.330.25	Axlor	V	25	22	9	21	Plain	-38					L
AX.11F.330.35	Axlor	V	27	33	23	33	Plain	-18					L
AX.11F.330.41	Axlor	V	33	27	11	27	Plain	36	33	25			R
AX.11B.360.33	Axlor	VI	17	26	9	26	Faceted	-17					L
AX.11B.350.1BIS	Axlor	VI	25	27	16	27	Plain	-49					L
AX.11B.350.76-114	Axlor	VI	18	21	5	11	Plain	16					R
AX.11B.350.12	Axlor	VI	24	41	10	41	Faceted	-35					L
Ax.11B.350.10	Axlor	VI	29	46	13	30	Faceted	12					R
AX.11B.350.2BIS	Axlor	VI	31	25	11	24	Plain	14					R
AX.11B.350.59	Axlor	VI	14	27	9	17	Plain	-32					L
AX.11B.350.65	Axlor	VI	19	25	9	14	Plain	48					R
AX.11C.360.1	Axlor	VI	42	44	11	43	Faceted	23					R
AX.11C.360.7	Axlor	VI	39	21	6	10	Faceted	11					R
AX.11C.360.40	Axlor	VI	15	25	9	21	Plain	25	17				R
AX.11C.360.70	Axlor	VI	15	33	8	25	Faceted	34	28				R
AX.11B.345.4	Axlor	VI	24	34	9	19	Plain	63	-7				R
AX.11B.375.20	Axlor	VI	27	44	10	35	Faceted	79					R
AX.11B.375.11	Axlor	VI	20	31	7	31	Dihedral	31					R
AX.11B.375.55	Axlor	VI	16	16	6	11	Faceted	-83					L

Anexo II

AX.11G.365.3	Axlor	VI	43	26	14	15	Plain	-22	-18				L
AX.11C.355.25	Axlor	VI	36	20	7	20	Faceted	16					R
AX.11C.355.1	Axlor	VI	29	20	9	15	Faceted	-32					L
AX.11C.375.58	Axlor	VI	23	17	4	9	Faceted	-53					L
AX.11C.345.5	Axlor	VI	25	35	9	21	Faceted	16					R
AX.11C.370.41	Axlor	VI	20	29	8	29	Faceted	20					R
AX.11C.370.46	Axlor	VI	21	12	5	9	Faceted	24					R
AX.11C.370.37	Axlor	VI	29	14	9	11	Faceted	41	32				R
AX.11C.350.8	Axlor	VI	34	25	14	26	Faceted	72	60				R
Ax.11C.350.15	Axlor	VI	29	25	11	24	Faceted	-10					L
AX.11C.350.7	Axlor	VI	25	36	10	14	Plain	-84					L
AX.11D.375.1	Axlor	VI	26	24	9	24	Faceted	35					R
AX.11D.350.29	Axlor	VI	19	30	18	26	Plain	51					R
AX.11B.390.15	Axlor	VII	33	37	9	14	Faceted	11	8				R
AX.11B.400.16	Axlor	VII	24	19	6	15	Faceted	-14					L
AX.11B.400.3	Axlor	VII	40	23	6	14	Faceted	-18					L
AX.11B.385.12	Axlor	VII	30	32	8	32	Dihedral	24					R
AX.11C.390.36	Axlor	VII	23	30	8	9	Faceted	-36					L
AX.11C.390.1	Axlor	VII	34	27	9	21	Faceted	-31					L
AX.11C.390.9	Axlor	VII	44	44	15	44	Faceted	20	17				R
AX.11C.385.9	Axlor	VII	17	23	8	23	Dihedral	-34					L
AX.11C.385.52	Axlor	VII	23	20	9	17	Faceted	39	39				R
AX.11C.385.4	Axlor	VII	19	50	13	20	Plain	-10					L
AX.11C.385.5	Axlor	VII	58	31	14	30	Faceted	35	29	11			R
AX.11D.385.3	Axlor	VII	28	23	4	15	Faceted	-30					L
AX.11E.385.3	Axlor	VII	21	16	5	9	Plain	73	31				R
AX.11B.415.11	Axlor	VIII	24	33	9	33	Faceted	54					R
AX.11B.410.6	Axlor	VIII	26	16	6	14	Faceted	72					R
AX.11B.405.30-31	Axlor	VIII	37	39	8	16	Faceted	53					R
AX.11B.405.56	Axlor	VIII	16	17	4	15	Faceted	38					R
AX.11G.410.2	Axlor	VIII	26	24	9	13	Plain	73					R
1	Le Moustier	I	55	40	14	44	Faceted	-32	-25				L
2	Le Moustier	I	44	40	14	31	Faceted	44	15				R
2	Le Moustier	I	40	32	15	32	Plain	22					R
3	Le Moustier	I	43	37	16	15	Faceted	47					R
3	Le Moustier	I	65	39	20	15	Faceted	-20					L
4	Le Moustier	I	45	35	17	20	Faceted	40	30				R
4	Le Moustier	I	30	33	14	15	Faceted	45	29				R
5	Le Moustier	I	33	32	17	30	Faceted	23					R
5	Le Moustier	I	50	30	20	25	Faceted	50	7				R
6	Le Moustier	I	51	57	23	57	Faceted	40	17	13			R
6	Le Moustier	I	56	65	25	65	Faceted	34					R
7	Le Moustier	I	43	40	17	36	Faceted	46					R
7	Le Moustier	I	40	46	25	30	Faceted	-39	-14	-11			L
8	Le Moustier	I	47	41	22	33	Plain	26	9				R

*Evaluación arqueológica del proceso de lateralización*

8	Le Moustier	I	55	45	30	30	Faceted	82					R
9	Le Moustier	I	64	41	14	23	Faceted	54					R
9	Le Moustier	I	47	70	24	65	Dihedral	18					R
10	Le Moustier	I	36	52	17	33	Plain	-39	-37	-31	-9		L
10	Le Moustier	I	31	45	17	40	Faceted	10	0				R
11	Le Moustier	I	31	34	12	34	Faceted	45					R
11	Le Moustier	I	49	34	16	30	Faceted	49					R
12	Le Moustier	I	72	47	17	47	Faceted	-19	-5				L
12	Le Moustier	I	36	46	24	46	Faceted	53	30	26	-2		R
13	Le Moustier	I	60	44	16	30	Faceted	35	27				R
13	Le Moustier	I	31	40	20	38	Faceted	41	11				R
14	Le Moustier	I	44	38	19	25	Faceted	24	15				R
14	Le Moustier	I	61	44	23	44	Faceted	-34					L
15	Le Moustier	I	26	36	20	36	Faceted	-53	-49				L
15	Le Moustier	I	51	50	30	27	Faceted	44	26				R
16	Le Moustier	I	57	55	21	53	Faceted	-43					L
16	Le Moustier	I	50	42	16	31	Faceted	-34					L
17	Le Moustier	I	45	46	20	26	Faceted	28	23	8			R
17	Le Moustier	I	39	40	16	37	Faceted	48	42				R
18	Le Moustier	I	72	52	24	24	Plain	23					R
18	Le Moustier	I	61	35	16	26	Plain	45	43	3			R
19	Le Moustier	I	62	65	31	29	Faceted	45	38	33			R
19	Le Moustier	I	47	33	15	20	Faceted	44	38	37			R
20	Le Moustier	I	49	60	20	60	Faceted	74	30	28			R
20	Le Moustier	I	61	33	16	20	Faceted	41					R
21	Le Moustier	I	37	30	13	16	Faceted	-13	-12				L
21	Le Moustier	I	46	50	20	50	Plain	45	30	3			R
22	Le Moustier	I	60	46	21	47	Faceted	58	29				R
22	Le Moustier	I	60	51	30	44	Faceted	-53					L
23	Le Moustier	I	39	34	20	34	Faceted	60	36	18	15		R
23	Le Moustier	I	30	35	10	12	Plain	-84					L
24	Le Moustier	I	51	45	15	20	Faceted	22					R
24	Le Moustier	I	55	56	14	16	Plain	21					R
25	Le Moustier	I	30	30	16	19	Plain	16					R
25	Le Moustier	I	73	45	20	32	Faceted	57					R
26	Le Moustier	I	36	41	13	30	Plain	51	35	11			R
26	Le Moustier	I	60	36	14	21	Plain	48	41	36			R
27	Le Moustier	I	67	60	14	40	Plain	-58					L
27	Le Moustier	I	40	46	19	33	Plain	-75					L
28	Le Moustier	I	46	43	31	31	Faceted	-64	-59	-53	-31		L
28	Le Moustier	I	50	50	15	40	Dihedral	41	26				R
29	Le Moustier	I	50	31	9	21	Faceted	55	40				R
29	Le Moustier	I	36	23	6	23	Faceted	-51					L
30	Le Moustier	I	39	31	11	27	Faceted	38					R
30	Le Moustier	I	34	41	16	40	Faceted	33					R

Anexo II

31	Le Moustier	I	50	32	13	29	Faceted	-27	-6				L
31	Le Moustier	I	29	24	11	19	Plain	-31					L
32	Le Moustier	I	54	41	13	34	Faceted	82	65	41			R
32	Le Moustier	I	34	33	15	15	Faceted	41					R
33	Le Moustier	I	34	25	26	23	Faceted	-58	-24				L
33	Le Moustier	I	59	46	25	43	Faceted	68	52	45	29		R
34	Le Moustier	I	49	29	24	20	Faceted	10	4				R
34	Le Moustier	I	65	63	16	40	Faceted	-38	-36				L
35	Le Moustier	I	51	36	15	27	Plain	-40	-22				L
35	Le Moustier	I	50	30	19	26	Plain	-50	-49				L
36	Le Moustier	I	27	35	11	35	Faceted	-59					L
36	Le Moustier	I	52	46	14	20	Plain	30	13				R
37	Le Moustier	I	81	44	22	40	Faceted	24					R
37	Le Moustier	I	46	34	13	25	Faceted	35					R
38	Le Moustier	I	23	25	9	20	Plain	47	6	7			R
38	Le Moustier	I	52	53	50	35	Faceted	26					R
39	Le Moustier	I	57	59	23	43	Faceted	-29	-27	-13	-7		L
39	Le Moustier	I	47	53	23	30	Faceted	-42					L
40	Le Moustier	I	50	32	24	35	Faceted	-38	-30				L
40	Le Moustier	I	54	42	16	39	Faceted	-67					L
41	Le Moustier	I	44	55	20	43	Faceted	19	19				R
41	Le Moustier	I	45	62	29	39	Faceted	21					R
42	Le Moustier	I	57	40	21	34	Faceted	63					R
42	Le Moustier	I	34	44	14	44	Faceted	-55					L
43	Le Moustier	I	51	55	16	55	Faceted	71					R
43	Le Moustier	I	35	48	20	48	Faceted	24					R
44	Le Moustier	I	33	60	15	40	Faceted	44	37				R
44	Le Moustier	I	46	61	32	49	Faceted	10					R
45	Le Moustier	I	39	48	23	20	Plain	-83	-51				L
45	Le Moustier	I	55	43	24	26	Faceted	-32					L
46	Le Moustier	I	46	45	14	34	Faceted	-39					L
46	Le Moustier	I	69	47	20	35	Faceted	30					R
47	Le Moustier	I	80	57	22	17	Faceted	27					R
47	Le Moustier	I	33	39	17	23	Faceted	55					R
48	Le Moustier	I	45	35	14	31	Faceted	22					R
48	Le Moustier	I	43	43	16	29	Faceted	18					R
49	Le Moustier	I	36	37	15	31	Faceted	-52					L
49	Le Moustier	I	68	36	24	28	Faceted	82	33				R
50	Le Moustier	I	47	45	15	39	Faceted	49	33				R
50	Le Moustier	I	39	40	14	33	Faceted	14					R
51	Le Moustier	I	65	44	25	33	Plain	50	31				R
51	Le Moustier	I	52	41	18	41	Faceted	38	27				R
52	Le Moustier	I	63	48	18	23	Faceted	67	47				R
52	Le Moustier	I	58	60	27	32	Faceted	66	51	46			R
53	Le Moustier	I	32	39	14	39	Faceted	-43	-40				L

*Evaluación arqueológica del proceso de lateralización*

53	Le Moustier	I	63	43	14	25	Plain	-37					L
54	Le Moustier	I	75	57	14	24	Plain	-30					L
54	Le Moustier	I	40	33	17	23	Faceted	-46					L
55	Le Moustier	I	33	39	19	20	Faceted	61	55	48	47		R
55	Le Moustier	I	35	34	21	9	Plain	47					R
56	Le Moustier	I	55	39	17	25	Plain	49					R
56	Le Moustier	I	53	34	23	25	Faceted	55	50				R
57	Le Moustier	I	64	46	19	46	Faceted	49	39	36	32	4	R
57	Le Moustier	I	59	51	23	24	Plain	-75	-57	-26			L
58	Le Moustier	I	53	43	17	33	Faceted	-39					L
58	Le Moustier	I	44	53	24	49	Faceted	29					R
59	Le Moustier	I	56	39	16	32	Faceted	24					R
59	Le Moustier	I	44	39	16	32	Faceted	25					R
60	Le Moustier	I	51	54	20	14	Plain	-43					L
60	Le Moustier	I	39	47	14	27	Faceted	63					R
61	Le Moustier	I	59	56	23	26	Faceted	-30					L
61	Le Moustier	I	49	40	22	31	Faceted	92	13				R
62	Le Moustier	I	41	42	19	35	Faceted	81					R
62	Le Moustier	I	39	51	19	36	Plain	-50					L
63	Le Moustier	I	66	63	18	60	Faceted	-44					L
63	Le Moustier	I	41	40	19	20	Plain	40	39				R
64	Le Moustier	I	49	53	23	24	Plain	21					R
64	Le Moustier	I	44	36	13	36	Faceted	81	21				R
65	Le Moustier	I	65	59	22	43	Faceted	56					R
65	Le Moustier	I	56	34	15	34	Faceted	44	32	10			R
66	Le Moustier	I	45	34	15	23	Faceted	80	32				R
66	Le Moustier	I	55	45	15	40	Faceted	32					R
67	Le Moustier	I	44	43	11	19	Faceted	37					R
67	Le Moustier	I	47	49	16	49	Faceted	33					R
68	Le Moustier	I	46	62	21	56	Faceted	-52	-43				L
68	Le Moustier	I	47	34	20	19	Faceted	-42	-34				L
69	Le Moustier	I	47	54	26	37	Faceted	61	33				R
69	Le Moustier	I	40	36	16	34	Faceted	39	31				R
70	Le Moustier	I	79	46	17	10	Faceted	69					R
70	Le Moustier	I	60	53	17	39	Faceted	37					R
71	Le Moustier	I	73	49	13	33	Faceted	44					R
71	Le Moustier	I	44	34	19	30	Faceted	42	21				R
72	Le Moustier	I	54	29	15	15	Faceted	25					R
72	Le Moustier	I	45	43	20	25	Faceted	-52					L
73	Le Moustier	I	44	39	16	26	Faceted	51	35				R
73	Le Moustier	I	40	40	25	40	Faceted	18	12				R
74	Le Moustier	I	36	37	18	21	Faceted	54	42	23	9	8	R
74	Le Moustier	I	55	35	16	25	Faceted	53					R
75	Le Moustier	I	50	30	14	27	Faceted	-40	-40				L
75	Le Moustier	I	56	49	23	19	Faceted	-44	-39				L



Anexo II

76	Le Moustier	I	35	23	24	54	Faceted	-46					L
76	Le Moustier	I	39	36	15	30	Dihedral	-56	-29	-28			L
77	Le Moustier	I	49	53	21	53	Faceted	-71	-23				L
77	Le Moustier	I	51	43	20	25	Faceted	-48					L
78	Le Moustier	I	49	45	19	25	Plain	-75					L
78	Le Moustier	I	56	34	19	27	Plain	-76	-41	-37			L
79	Le Moustier	I	47	52	24	52	Faceted	-49					L
79	Le Moustier	I	43	36	16	36	Faceted	-76	-18				L
80	Le Moustier	I	46	46	17	20	Faceted	-39					L
80	Le Moustier	I	39	43	18	24	Faceted	77	27				R
81	Le Moustier	I	30	30	24	46	Faceted	31					R
81	Le Moustier	I	53	57	16	57	Faceted	30					R
82	Le Moustier	I	39	45	25	15	Faceted	30					R
82	Le Moustier	I	49	47	20	13	Faceted	55					R
83	Le Moustier	I	59	40	14	16	Faceted	62					R
83	Le Moustier	I	52	40	22	21	Faceted	23	12				R
84	Le Moustier	I	40	45	18	45	Faceted	43	42				R
84	Le Moustier	I	46	40	15	20	Faceted	18					R
85	Le Moustier	I	37	60	24	60	Faceted	71	60	43	31	26	R
85	Le Moustier	I	64	40	20	29	Faceted	59	34	32			R
86	Le Moustier	I	45	40	15	25	Faceted	52	45				R
86	Le Moustier	I	23	57	15	57	Faceted	40	35				R
87	Le Moustier	I	51	60	20	55	Faceted	19					R
87	Le Moustier	I	33	35	9	35	Faceted	74	41				R
88	Le Moustier	I	60	40	24	24	Faceted	61					R
88	Le Moustier	I	45	50	14	25	Faceted	57					R
89	Le Moustier	I	30	32	14	32	Faceted	39					R
89	Le Moustier	I	61	54	14	17	Plain	37	24	9			R
90	Le Moustier	I	44	39	17	24	Faceted	33					R
90	Le Moustier	I	56	34	17	34	Faceted	53					R
91	Le Moustier	I	55	63	19	27	Plain	33	7	1			R
91	Le Moustier	I	45	51	16	27	Plain	-40	-28	-18			L
92	Le Moustier	I	50	60	21	60	Faceted	38	27				R
92	Le Moustier	I	44	34	17	20	Faceted	-51					L
93	Le Moustier	I	54	33	19	20	Plain	-49	-44				L
93	Le Moustier	I	59	44	31	44	Plain	-38	-29				L
94	Le Moustier	I	32	25	16	23	Plain	36	27	15			R
94	Le Moustier	I	40	36	30	24	Plain	57					R
95	Le Moustier	I	53	53	14	27	Faceted	39					R
95	Le Moustier	I	37	36	17	34	Faceted	52					R
96	Le Moustier	I	45	49	28	21	Faceted	39	10				R
96	Le Moustier	I	43	44	21	32	Faceted	81	43	29	25		R
97	Le Moustier	I	41	36	13	21	Faceted	30					R
97	Le Moustier	I	60	43	14	20	Plain	45					R
98	Le Moustier	I	31	40	23	16	Faceted	60	10				R

*Evaluación arqueológica del proceso de lateralización*

98	Le Moustier	I	37	60	20	60	Faceted	36					R
99	Le Moustier	I	54	39	12	30	Faceted	-53					L
99	Le Moustier	I	60	44	14	16	Faceted	41					R
100	Le Moustier	I	52	64	20	25	Plain	39	20				R
100	Le Moustier	I	55	30	16	24	Faceted	35	27				R
101	Le Moustier	I	43	31	20	15	Faceted	48					R
101	Le Moustier	I	55	50	14	14	Plain	36	30				R
102	Le Moustier	I	55	41	21	15	Faceted	22					R
102	Le Moustier	I	46	34	19	19	Plain	17					R
103	Le Moustier	I	45	42	20	31	Faceted	49	28				R
103	Le Moustier	I	63	55	25	21	Plain	-31					L
104	Le Moustier	I	46	45	19	25	Faceted	-59	-59				L
104	Le Moustier	I	64	46	21	43	Faceted	40	49				R
105	Le Moustier	I	39	32	13	32	Faceted	41					R
105	Le Moustier	I	56	31	23	31	Faceted	52					R
106	Le Moustier	I	39	26	17	17	Plain	50					R
106	Le Moustier	I	34	63	19	63	Faceted	57					R
107	Le Moustier	I	62	57	20	57	Faceted	82	45	19			R
107	Le Moustier	I	44	47	17	39	Faceted	69					R
108	Le Moustier	I	50	35	21	26	Plain	-25					L
108	Le Moustier	I	37	35	24	26	Faceted	40					R
109	Le Moustier	I	47	27	17	16	Plain	27					R
109	Le Moustier	I	50	26	14	24	Plain	61					R
110	Le Moustier	I	31	30	20	27	Faceted	57	2				R
110	Le Moustier	I	31	44	14	14	Plain	46	26				R
111	Le Moustier	I	36	26	14	20	Plain	63	39				R
111	Le Moustier	I	37	43	14	21	Plain	59					R
112	Le Moustier	I	55	26	21	15	Faceted	-42					L
112	Le Moustier	I	46	43	24	34	Faceted	-39					L
113	Le Moustier	I	50	27	20	20	Faceted	30					R
113	Le Moustier	I	21	43	26	43	Faceted	43					R
114	Le Moustier	I	44	37	23	37	Faceted	69					R
114	Le Moustier	I	40	40	14	29	Faceted	25					R
115	Le Moustier	I	-	-	-	-	Faceted	-20					L
115	Le Moustier	J	56	57	22	15	Plain	-39					L
116	Le Moustier	J	48	43	12	25	Plain	-56					L
116	Le Moustier	J	34	36	14	36	Faceted	12					R
117	Le Moustier	J	65	46	14	43	Faceted	30	15	14	14		R
117	Le Moustier	J	56	45	21	45	Faceted	76	73	73	40		R
118	Le Moustier	J	65	34	13	25	Faceted	-75					L
118	Le Moustier	J	35	30	7	20	Faceted	12	9				R
119	Le Moustier	J	40	38	11	25	Plain	-44	-33				L
119	Le Moustier	J	30	39	9	26	Faceted	57					R
120	Le Moustier	J	34	46	11	19	Plain	74					R
120	Le Moustier	J	37	23	15	5	Plain	-36					L

Anexo II

121	Le Moustier	J	40	40	13	39	Faceted	-92					L
121	Le Moustier	J	33	45	14	35	Faceted	74					R
122	Le Moustier	J	53	33	22	24	Plain	48	24				R
122	Le Moustier	J	44	30	20	15	Plain	23					R
123	Le Moustier	J	29	37	13	30	Plain	54	17				R
123	Le Moustier	J	47	30	10	26	Faceted	90	68				R
124	Le Moustier	J	44	34	12	24	Faceted	-46	-36				L
124	Le Moustier	J	60	42	25	32	Faceted	-83	-60	-38	-34		L
125	Le Moustier	J	43	27	20	19	Faceted	33	18				R
125	Le Moustier	J	50	26	12	15	Faceted	-66	-52	-47			L
126	Le Moustier	J	65	52	15	25	Plain	36					R
126	Le Moustier	J	55	45	10	35	Faceted	67	26				R
127	Le Moustier	J	60	41	15	11	Plain	57	36				R
127	Le Moustier	J	45	30	10	23	Faceted	-50					L
128	Le Moustier	J	44	56	12	25	Faceted	36	21				R
128	Le Moustier	J	65	52	13	43	Faceted	-85					L
129	Le Moustier	J	60	52	16	52	Faceted	-41					L
129	Le Moustier	J	47	58	10	20	Faceted	48					R
130	Le Moustier	J	43	42	13	30	Dihedral	34	15				R
130	Le Moustier	J	51	24	9	21	Faceted	43					R
131	Le Moustier	J	48	44	9	13	Faceted	33					R
131	Le Moustier	J	43	35	8	35	Faceted	57	12				R
132	Le Moustier	J	52	60	14	36	Plain	30					R
132	Le Moustier	J	57	32	11	17	Faceted	87					R
133	Le Moustier	J	43	30	13	21	Faceted	49	49	17			R
133	Le Moustier	J	75	46	15	46	Faceted	-67	-18				L
134	Le Moustier	J	73	43	20	34	Faceted	51					R
134	Le Moustier	J	70	50	14	24	Plain	-70	-62	-21	-11	3	L
135	Le Moustier	J	70	45	13	16	Dihedral	66					R
135	Le Moustier	J	75	40	15	21	Plain	71					R
136	Le Moustier	J	51	33	13	20	Faceted	87	37				R
136	Le Moustier	J	43	27	19	25	Plain	40	38	25	22		R
137	Le Moustier	J	61	41	13	14	Plain	29					R
137	Le Moustier	J	63	32	13	17	Plain	-54					L
138	Le Moustier	J	50	27	10	12	Faceted	69	41				R
138	Le Moustier	J	75	54	16	26	Plain	57					R
139	Le Moustier	J	62	44	14	36	Faceted	23	20	18	17		R
139	Le Moustier	J	70	40	13	14	Plain	69	62				R
140	Le Moustier	J	36	53	20	25	Plain	-63					L
140	Le Moustier	J	33	34	9	27	Faceted	-42	-32				L
141	Le Moustier	J	43	26	10	29	Faceted	-82	-36				L
141	Le Moustier	J	47	63	20	30	Plain	53	42				R
142	Le Moustier	J	32	43	11	26	Faceted	-17					L
142	Le Moustier	J	55	60	24	20	Faceted	27	10				R
143	Le Moustier	J	37	46	16	34	Faceted	-20	-67				L

*Evaluación arqueológica del proceso de lateralización*

143	Le Moustier	J	48	43	20	23	Plain	30					R
144	Le Moustier	J	67	46	8	25	Plain	-29	-19				L
144	Le Moustier	J	49	50	14	11	Plain	46					R
145	Le Moustier	J	60	52	17	27	Plain	-10					L
145	Le Moustier	J	46	44	16	21	Faceted	55					R
146	Le Moustier	J	55	55	21	23	Faceted	-17	-37				L
146	Le Moustier	J	40	23	10	23	Faceted	85	17				R
147	Le Moustier	J	50	45	14	12	Plain	35					R
147	Le Moustier	J	63	60	20	17	Plain	-63					L
148	Le Moustier	J	55	63	11	32	Faceted	-59					L
148	Le Moustier	J	46	40	13	30	Plain	-37	-27				L
149	Le Moustier	J	25	40	10	40	Faceted	-28					L
149	Le Moustier	J	49	37	13	27	Faceted	64	17				R
150	Le Moustier	J	45	56	20	51	Faceted	61					R
150	Le Moustier	J	24	36	12	34	Faceted	80					R
151	Le Moustier	J	42	21	12	20	Faceted	61					R
151	Le Moustier	J	55	46	16	53	Faceted	-31					L
152	Le Moustier	J	53	25	12	25	Faceted	-78	-41				L
152	Le Moustier	J	50	50	10	30	Faceted	-48					L
153	Le Moustier	J	46	43	15	29	Faceted	-32					L
153	Le Moustier	J	44	27	10	17	Faceted	-46					L
154	Le Moustier	J	45	36	23	26	Faceted	-71	-52				L
154	Le Moustier	J	60	63	13	33	Faceted	71					R
155	Le Moustier	J	63	56	16	40	Faceted	21	8	7			R
155	Le Moustier	J	55	47	15	34	Faceted	51	51	51			R
156	Le Moustier	J	54	45	13	33	Faceted	33	22				R
156	Le Moustier	J	39	44	10	47	Faceted	84					R
157	Le Moustier	J	46	43	13	24	Faceted	75	20				R
157	Le Moustier	J	40	43	13	43	Faceted	55					R
158	Le Moustier	J	44	40	15	23	Plain	17	9	5	5		R
158	Le Moustier	J	31	42	9	43	Faceted	-62					L
159	Le Moustier	J	41	41	14	40	Faceted	-14					L
159	Le Moustier	J	47	53	13	50	Faceted	45	7				R
160	Le Moustier	J	50	52	24	34	Plain	-38					L
160	Le Moustier	J	34	40	14	24	Faceted	-40					L
161	Le Moustier	J	54	36	10	21	Faceted	53					R
161	Le Moustier	J	40	36	12	27	Faceted	14					R
162	Le Moustier	J	43	36	14	35	Faceted	21					R
162	Le Moustier	J	53	34	17	34	Faceted	45	42	24			R
163	Le Moustier	J	39	43	10	26	Plain	21	14	6			R
163	Le Moustier	J	57	36	21	35	Faceted	47	13				R
164	Le Moustier	J	71	40	20	27	Faceted	13	11				R
164	Le Moustier	J	61	39	26	41	Faceted	-24	-22				L
165	Le Moustier	J	63	34	20	24	Faceted	40					L
165	Le Moustier	J	53	57	22	50	Faceted	26	12	5	9		R

Anexo II

166	Le Moustier	J	34	43	11	32	Faceted	15					R
166	Le Moustier	J	66	79	19	25	Plain	46	43	21			R
167	Le Moustier	J	49	30	16	15	Faceted	37					R
167	Le Moustier	J	32	74	21	37	Plain	38	27				R
168	Le Moustier	J	-	-	-	-	Faceted	21					R
168	Le Moustier	J	64	50	14	40	Faceted	10					R
169	Le Moustier	J	31	40	15	40	Faceted	58					R
169	Le Moustier	J	34	38	14	33	Plain	29					R
170	Le Moustier	J	67	39	20	24	Plain	60					R
170	Le Moustier	J	57	31	12	20	Faceted	41					R
171	Le Moustier	J	46	42	13	21	Faceted	80	10				R
171	Le Moustier	J	54	33	18	30	Faceted	-62					L
172	Le Moustier	J	34	40	14	30	Plain	-37	-24				L
172	Le Moustier	J	82	29	15	21	Faceted	10					R
173	Le Moustier	J	46	33	19	17	Plain	12	5				R
173	Le Moustier	J	70	37	10	20	Faceted	10					R
174	Le Moustier	J	60	34	11	30	Faceted	65	55	12			R
174	Le Moustier	J	50	52	15	34	Faceted	50	36				R
175	Le Moustier	J	54	45	15	34	Faceted	57	33				R
175	Le Moustier	J	35	45	15	30	Faceted	-56					L
176	Le Moustier	J	57	49	15	48	Faceted	-44					L
176	Le Moustier	J	50	46	16	44	Faceted	-25					L
177	Le Moustier	J	44	41	13	37	Faceted	-38					L
177	Le Moustier	J	44	60	13	16	Plain	14	9				R
178	Le Moustier	J	54	50	23	50	Faceted	23					R
178	Le Moustier	J	32	46	13	43	Faceted	53	40				R
179	Le Moustier	J	39	53	16	40	Faceted	12	6				R
179	Le Moustier	J	33	35	14	35	Faceted	23	7				R
180	Le Moustier	J	41	52	17	52	Faceted	27	21	19			R
180	Le Moustier	J	45	65	15	50	Faceted	40					R
181	Le Moustier	J	36	48	9	11	Plain	-76	-25				L
181	Le Moustier	J	38	58	15	55	Faceted	44					R
182	Le Moustier	J	45	60	15	55	Faceted	13	19				R
182	Le Moustier	J	45	43	16	43	Faceted	58					R
183	Le Moustier	J	47	43	15	35	Faceted	-46					L
183	Le Moustier	J	40	39	12	23	Faceted	47					R
184	Le Moustier	J	45	50	12	50	Faceted	56	-1				R
184	Le Moustier	J	44	46	14	30	Faceted	49					R
185	Le Moustier	J	37	40	13	35	Faceted	14					R
185	Le Moustier	J	60	50	12	40	Faceted	21					R
186	Le Moustier	J	40	34	10	27	Faceted	62					R
186	Le Moustier	J	56	40	15	33	Faceted	76	25	22			R
187	Le Moustier	J	50	47	17	43	Faceted	50	0	-9			R
187	Le Moustier	J	50	47	13	30	Faceted	-77	-42	-7			L
188	Le Moustier	J	60	55	17	40	Plain	-65					L

*Evaluación arqueológica del proceso de lateralización*

188	Le Moustier	J	50	55	15	45	Faceted	-32	-2				L
189	Le Moustier	J	87	60	16	37	Faceted	-37					L
189	Le Moustier	J	54	34	14	19	Faceted	-42					L
190	Le Moustier	J	62	37	11	26	Faceted	71					R
190	Le Moustier	J	71	46	9	16	Faceted	-40					L
191	Le Moustier	J	60	40	9	25	Faceted	54					R
191	Le Moustier	J	45	40	15	20	Faceted	-29					L
192	Le Moustier	J	35	31	10	20	Dihedral	56	12				R
192	Le Moustier	J	51	47	11	45	Faceted	81					R
193	Le Moustier	J	45	35	13	25	Faceted	10	8	8			R
193	Le Moustier	J	46	45	10	36	Faceted	26	18	-9			R
194	Le Moustier	J	43	40	14	38	Faceted	-30	-21				L
194	Le Moustier	J	45	61	11	33	Faceted	-33					L
195	Le Moustier	J	71	68	20	20	Faceted	46	11				R
195	Le Moustier	J	40	48	14	44	Faceted	-51					L
196	Le Moustier	J	65	46	13	15	Plain	28	16				R
196	Le Moustier	J	60	34	10	12	Plain	52	9				R
197	Le Moustier	J	53	37	10	16	Plain	43					R
197	Le Moustier	J	63	36	10	25	Faceted	-19					L
198	Le Moustier	J	50	45	10	30	Faceted	47					R
198	Le Moustier	J	29	44	16	20	Plain	-36					L
199	Le Moustier	J	50	43	15	40	Faceted	60					R
199	Le Moustier	J	45	45	16	40	Faceted	54					R
200	Le Moustier	J	42	56	19	31	Faceted	62	35	18			R
200	Le Moustier	J	45	51	15	51	Faceted	48	44	12			R
201	Le Moustier	J	42	45	16	45	Faceted	-65	-54				L
201	Le Moustier	J	30	45	14	40	Faceted	-55					L
202	Le Moustier	J	56	63	20	53	Faceted	-51	-33	-22			L
202	Le Moustier	J	34	41	16	41	Faceted	34					R
203	Le Moustier	J	32	42	15	42	Faceted	59	9				R
203	Le Moustier	J	52	55	20	61	Faceted	46	30				R
204	Le Moustier	J	46	33	14	33	Faceted	28					R
204	Le Moustier	J	50	43	20	45	Faceted	70					R
205	Le Moustier	J	23	30	10	25	Plain	27					R
205	Le Moustier	J	55	35	12	20	Faceted	38					R
206	Le Moustier	J	25	46	12	40	Plain	-80					L
206	Le Moustier	J	33	41	13	41	Faceted	74	52				R
207	Le Moustier	J	-	-	-	-	Faceted	-11					L
VAUF J12 C VII 151	Vaufrey	VII	70	43	10	17	Plain	56					R
VAUF K15 C VII 211	Vaufrey	VII	71	25	10	16	Faceted	48	2				R
VAUF K15 C VII 140	Vaufrey	VII	54	43	12	41	Faceted	44					R
VAUF K15 C VII 148	Vaufrey	VII	40	40	10	21	Faceted	-74					L
VAUF H11-25 C VII	Vaufrey	VII	91	36	16	23	Plain	10					R
VAUF I10 37 C VII	Vaufrey	VII	50	39	9	25	Faceted	11	7				R
VAUF H11-13 C VII	Vaufrey	VII	65	57	20	32	Faceted	43					R

*Anexo II*

VAUF H12 27	Vaufrey	VII	70	46	11	30	Faceted	31	25	2			R
VAUF H10-36 C VII	Vaufrey	VII	52	34	14	25	Plain	-64					L
VAUF K15 156 C VII	Vaufrey	VII	40	32	10	30	Dihedral	26					R
VAUF I12 110	Vaufrey	VII	97	64	24	64	Faceted	67	33				R
VAUF I10 35 C VII	Vaufrey	VII	64	37	17	32	Faceted	-48					L
VAUF H12 29	Vaufrey	VII	87	51	20	51	Faceted	-13					L
VAUF K15 C VII 191	Vaufrey	VII	65	50	17	35	Faceted	-36					L
VAUF K15 C VII 197	Vaufrey	VII	64	50	10	27	Faceted	35					R
VAUF J15 C VII 38	Vaufrey	VII	62	57	14	20	Plain	52					R
VAUF J15 C VII 16	Vaufrey	VII	70	40	14	31	Faceted	59					R
VAUF I11 68 C VII	Vaufrey	VII	26	26	10	20	Plain	-21	-16	-4			L
VAUF K14 C VII 218	Vaufrey	VII	55	29	14	20	Faceted	18					R
VAUF K16 C VII 234	Vaufrey	VII	55	35	13	20	Faceted	64					R
VAUF J15 C VII 29	Vaufrey	VII	65	43	11	16	Faceted	14					R
VAUF K13 C VII 136	Vaufrey	VII	27	37	13	25	Faceted	36					R
VAUF K13 C VII 201	Vaufrey	VII	64	36	7	20	Faceted	41					R
VAUF K12 C VII 225	Vaufrey	VII	70	36	14	21	Plain	-55					L
VAUF K13 C VII 180	Vaufrey	VII	40	41	13	22	Plain	77					R
VAUF H10 57 C VII	Vaufrey	VII	24	34	10	30	Dihedral	58					R
VAUF G6 41 C VII	Vaufrey	VII	22	45	14	34	Plain	-61					L
VAUF K15 C VII 299	Vaufrey	VII	56	37	11	36	Faceted	31					R



