

# Iterative Learning Control and Gaussian Process Regression for Hydraulic Cushion Control <sup>★</sup>

Ignacio Trojaola <sup>\*</sup> Iker Elorza <sup>\*</sup> Eloy Irigoyen <sup>\*\*</sup>  
Aron Pujana-Arrese <sup>\*</sup> Carlos Calleja <sup>\*</sup>

<sup>\*</sup> Ikerlan Technology Research Centre, Control and Monitoring Area,  
Arrasate-Mondragon, Spain (e-mail: [itrojaola@ikerlan.es](mailto:itrojaola@ikerlan.es)).

<sup>\*\*</sup> UPV/EHU, Plaza Ingeniero Torres Quevedo, 1, Bizkaia, Spain

**Abstract:** In this paper, we investigate on extending a feed-forward control scheme for the force control circuit of a hydraulic cushion with Gaussian Process nonlinear regression and Iterative Learning Control. Gaussian Processes allow the possibility of estimating the unknown proportional valve nonlinearities and provide uncertainty measurements of the predictions. However, the system must realize a high precision tracking control which is not achievable if any uncertainty remains in the estimation. Therefore, an extra feed-forward signal based on Iterative Learning Control is used to obtain a precise and fast force reference tracking performance. The design of the Iterative Learning Control is based on an inverted linearized model in which a fourth-order low-pass filter is included to attenuate the unknown valve dynamics. The low-pass filter is split up into two second-order low-pass filters, one of which is applied in the positive, the other in the negative, direction of time, resulting in zero-phase filtering. Simulation results show that Gaussian Process regression allows the possibility of using feed-forward control and that the force tracking performance is improved by introducing Iterative Learning Control.

Copyright © 2020 The Authors. This is an open access article under the CC BY-NC-ND license (<http://creativecommons.org/licenses/by-nc-nd/4.0>)

**Keywords:** Iterative Learning Control, Gaussian Processes, Force Control, Iterative Improvement, Hydraulic systems.

## 1. INTRODUCTION

During the drawing process of a hydraulic press, it is necessary to control the blank-holder force to achieve the correct forming of the workpiece. The force controller acts to maintain the blank-holder target force regardless of the impact velocity of the slide over the cushion.

The blank-holder force control is carried out by regulating a proportional valve's opening ratio so that the desired pressure in the cushion's cylinder chamber is achieved H. Gharib, A.S. Wifi, M. Younan (2006). It is fundamental to obtain an accurate pressure tracking as there usually exist workpiece design specifications regarding the maximum peak pressure allowed in the cylinder chamber and the settling time of the pressure signal.

PI control is commonly used to compute the feedback control signal for the valve and control the pressure in the cylinder. Nonetheless, the hydraulic cushion circuit is highly nonlinear due to the effects of nonlinear flow through the valve and the pressure-induced changes in the oil compressibility. Furthermore, apart from the valve's nonlinear behavior, its dynamics are complex and not precisely known. The PI controller could be tuned for a linearized operating point, however, if the system deviates

from said operating point it would result in poorer result Nakamura and Matsuyama (1998). Several theoretical studies have been carried out in order to improve the performance of the PI controller in circuits where valves are used to control the operation of hydraulic cylinders. These approaches have their foundation on model-based control designs which allow the possibility of using techniques such as feed-forward (FF), feedback or feedback-linearization (FL).

The tracking performance of a sinusoidal position reference of a linear hydraulic actuator is improved in Manring et al. (2017). Introducing FL and using the pressure sensor signals of the pump and the actuator, the load dependence of the tracking response was reduced considerably.

FF to improve the tracking performance of a PID controller was used in Visioli (2004), for a first-order and a fourth-order system with dead time. As the authors pointed out, this technique will not achieve satisfactory results if the model suffers from significant uncertainties, resulting in a highly model-dependent approach.

A comparison between different model-based control approaches for the force control system of a hydraulic actuator was carried out in Conrad and Jensen (2017). They concluded that the best results were given by combining state estimate feedback, output unity feedback, and a velocity FF loop.

<sup>★</sup> This work has been partially funded by the Department of Development and Infrastructures of the Government of the Basque Country, via Industrial Doctoral Program BIKAINTEK (Official Bulletin of the Basque Country n°67 on 09/04/18.)

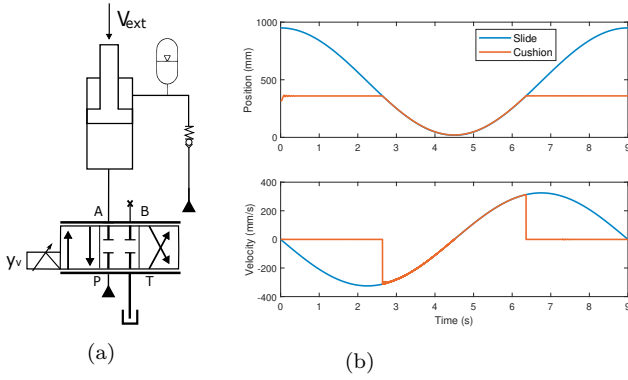

Fig. 1. Hydraulic cushion force circuit and the cylinder  $V_{ext}$  given by the slide position.

The improvement of press behavior via the application of model-based techniques, such as FF and FL, is significant as long as there is detailed information about the dynamics of each particular press Bai et al. (2013). Nevertheless, the dynamics and some nonlinearities of the valve are not available. We, therefore, propose a PI+FF+FL scheme combined with Gaussian Process (GP) nonlinear regression and Iterative Learning Control (ILC) algorithms.

## 2. FORCE CONTROLLER DESIGN

Figure 1a shows the force control circuit of a hydraulic cushion. The circuit consists of an active cylinder with an external velocity disturbance  $V_{ext}$  from the slide, a proportional valve that controls the pressure inside the cylinder chamber and a pump line with a non-return valve that allows flow in only one direction. An accumulator is included in order to maintain a constant pressure level in the top cylinder chamber during the press cycle.

The force control system is activated during the drawing process when the slide makes contact with the cushion (see Fig. 1b). During this process, a negative input signal,  $y_v$ , between -1 and 0 is sent to the valve, which moves the spool position to the left, in order to connect port A with port T and port P with port B. At this valve position, oil is channeled through the valve from the cylinder to the tank, retracting the cylinder.

Once the drawing process is finished, the cylinder needs to be extended to its initial position to start the press cycle again. By sending a positive input signal between 0 and 1 to the valve, the spool position is moved to the right, to connect port B with port T and port P with port A. The slide returns to its initial position and the fluid from the pump line extends the cylinder in order to follow the slide.

### 2.1 Hydraulic Component Modeling

The relationship between the volumetric flow out of the valve and the pressure inside the cylinder is given as:

$$q = -K_v(y_v)\sqrt{P}, \quad (1)$$

where  $q$  is the flow out of the valve,  $P$  is the cylinder pressure and  $K_v(y_v)$  is the hydraulic conductance, referred to as valve coefficient in Merritt (1967), which is a function of

the valve's spool position  $y_v$ <sup>1</sup>. The hydraulic conductance function is nonlinear and it is often obtained via empirical tests as it is specific for each valve.

As pointed out in Sec. 1, due to the highly dynamic behavior and the unknown nonlinearities of the valve it is hard to obtain an accurate physical model of the valve dynamics. However, they are usually modeled as a second-order transfer function, see Zhang et al. (2002), or even neglected as in Rahmat et al. (2011). In this study, the dynamics of the valve will not be modeled, which makes Eq. 1 a static function.

The relationship between the volumetric flow into the cylinder, the pressure inside the cylinder chamber and the piston motion is given as:

$$q = A\dot{x} + (V_d + Ax)\beta\dot{P}. \quad (2)$$

where  $A$ ,  $V_d$  and  $\beta$  are the piston area, the dead volume of the cylinder chamber and the hydraulic compressibility respectively, see Rahmat et al. (2011). Variable  $x$  is the piston position.

### 2.2 Control Design

The disturbances and the unknown nonlinearities existing in the system are big obstacles when it comes to designing a controller to regulate the valve spool position. It is, therefore, proposed to perform feedback linearization (FL) and feed-forward (FF), to cancel the system nonlinearities and eliminate the velocity disturbance respectively.

Based on Eqs. 1 and 2 we can perform FL and FF to obtain an estimation of the valve position  $\hat{y}_v$ , resulting in:

$$\hat{y}_v = -\hat{K}_v^{-1} \left( \underbrace{\frac{\dot{P}(V_d + Ax)\beta}{\sqrt{P}}}_{FL} + \underbrace{\frac{A\dot{x}}{\sqrt{P}}}_{FF} \right), \quad (3)$$

the velocity disturbance will be eliminated by the FF term as it will anticipate the sudden velocity increase in the cylinder and the pressure error that will result due to the slowing slide. By canceling the nonlinearities with the FL term, an equivalent linear system will be obtained so that the PI controller performance will be satisfactory for any operating point. The resulting block diagram after combining PI+FL+FF controllers is shown in Fig. 2:

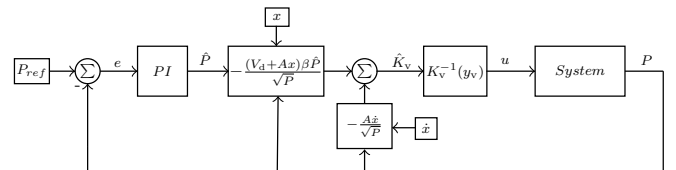

Fig. 2. Force controller block diagram.

The output of the PI controller is,  $\hat{P}$ , which generally differs from  $\dot{P}$  in the FL+FF Eq. 3. If no uncertainty is

<sup>1</sup> The force control can be done either by pressure or a force reference signal. In this study, the force signal will be used for hydraulic cushion control. The force relates to the pressure by  $F = P \cdot A$ .

present in the system, i.e. system parameters and valve hydraulic conductance are known, most of the terms will cancel out except for the valve dynamics,  $G_v$ , which are not included in the FL+FF design. Therefore, the final block diagram shown in Fig. 3 will remain.

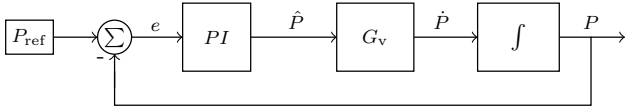

Fig. 3. Force controller block diagram.

The resulting block diagram is obtained under the assumption that our estimation of  $K_v(y_v)$ , denoted as  $\hat{K}_v(y_v)$  in Eq. 3, is exact.

Provided these conditions are met, an accurate force reference tracking is obtained, as shown in Fig. 4. The  $K_v(y_v)$  value shown in y-axis has been normalized with respect to the nominal pressure and the nominal flow of the valve.

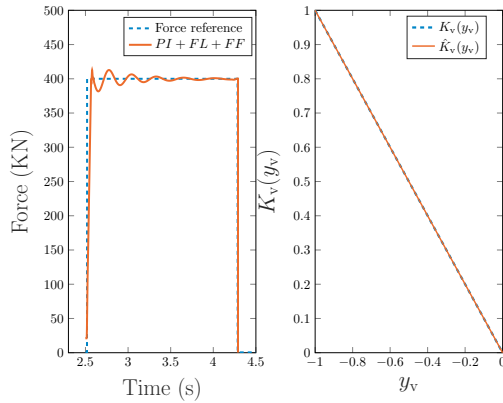

Fig. 4. PI+FF+FL 600 kN force reference tracking with exact  $K_v(y_v)$  estimation.

If the estimation  $\hat{K}_v(y_v)$  differs from the real one, the controller response will be penalized, as shown in Fig. 5:

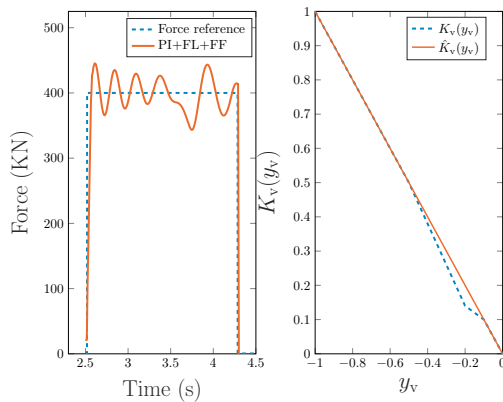

Fig. 5. PI+FF+FL 600 kN force reference tracking with imprecise  $K_v(y_v)$  estimation.

As already concluded by Honegger and Corke (2001); Manning et al. (2017); Visioli (2004), for the PI+FF+FL

to work, it is necessary to know every system parameter so that they can be canceled out to obtain accurate reference tracking. From the FF+FL Eq. 3, every parameter but  $K_v(y_v)$  can be obtained either from sensors or from data-sheets provided by manufacturers. Therefore,  $K_v(y_v)$  has to be known beforehand to obtain a precise reference tracking.

There exist a great deal of techniques to estimate the value of  $K_v(y_v)$ , e.g. Neural Networks, Kalman filters or Support Vector Machine. In this paper, Gaussian Process nonlinear estimation will be used as they allow hyperparameter optimization and a good trade-off between fitting the data and smoothing.

### 3. GAUSSIAN PROCESSES

Gaussian Processes (GP) are a powerful non-parametric tool for nonlinear regression, which are fully described by a mean function  $m(\cdot)$  and a covariance function  $\Sigma$ . The covariance function is a measure of the closeness between inputs see Ko et al. (2007).

Let us consider a dynamical system with a one-dimensional input,  $y_v$ , and one single output  $z$ :

$$z = \hat{K}_v(y_v) + \epsilon, \quad (4)$$

where  $\epsilon \sim \mathcal{N}(0, \sigma_n^2)$  is an additive i.i.d. Gaussian system noise with variance  $\sigma_n^2$ .

Suppose that the training data set is  $\mathcal{D} = \{y_{v_i}, z_i\}_{i=1}^N$  where  $N$  is the number of training samples. We want to perform a prediction of the final value of an arbitrary input  $y'_v$  based on the training data available. In our case, the training samples will be noisy valve spool positions obtained by simulation from which a dynamic model,  $\hat{K}_v(y_v)$ , will be obtained.

In this paper, we consider a prior mean function  $m \equiv 0$  and a squared exponential covariance function:

$$C(y_{v_i}, y_{v_j}) = \sigma^2 \exp\left(\left(-\frac{1}{2}(y_{v_i} - y_{v_j})\right) \Lambda^{-1} \left(-\frac{1}{2}(y_{v_i} - y_{v_j})\right)^T\right), \quad (5)$$

where  $\sigma^2$  is the variance of the function  $\hat{K}_v(y_v)$  and the diagonal matrix  $\Lambda := \text{diag}(l^2)$  is dependent on the characteristic length scale.

The mean and the variance of the GP prediction are:

$$\begin{aligned} \mu(z) &= \mathbf{k}(y'_v)^T (\mathbf{K} + \sigma_w^2 I)^{-1} z \\ \sigma_{GP}^2(z) &= k(y'_v) - \mathbf{k}^T(y'_v) (\mathbf{K} + \sigma_w^2 I)^{-1} \mathbf{k}(y'_v) \end{aligned} \quad (6)$$

where  $\mathbf{k}(y'_v) = [C(y_{v_1}, y_{v'}), \dots, C(y_{v_N}, y_{v'})]$  is the  $N \times 1$  vector of covariances between training inputs and test input,  $T$  is the transpose operator,  $\mathbf{K}$  is the  $N \times N$  covariance matrix with entries  $K_{ij} = C(y_{v_i}, y_{v_j})$  and  $k(y_{v'}) = C(y_{v'}, y_{v'})$  is the autocovariance of the test input.

Let us introduce a new vector notation for the parameters of the GP,  $\theta = [l, \sigma_w, \sigma]$ . The learning of the hyperparameters is carried out by maximizing the log-likelihood of the training outputs given the inputs see, Williams, Christopher KI and Rasmussen (2006), that is:

$$\hat{\theta} = \arg \max_{\theta} \{\log(p(z|y_v, \theta))\}. \quad (7)$$

The log-likelihood term is as follows:

$$\begin{aligned} \log(p(z|y_v)) &= -\frac{1}{2}z^T (K + \sigma_w^2 I)^{-1} z \\ &\quad -\frac{1}{2}\log|K + \sigma_w^2 I| - \frac{N}{2}\log(2\pi). \end{aligned} \quad (8)$$

We train the GP model with squared exponential function on 50 samples where the true target has been set to be the  $K_v(y_v)$  function shown in Fig. 5. The training samples are obtained by decoupling the slide from the cushion, so that open-loop control can be applied to the latter. For the hydraulic circuit of the cushion, a specific  $y_v$  is applied to the valve, for which the cylinder's velocity and the cylinder's pressure settle at a constant value.

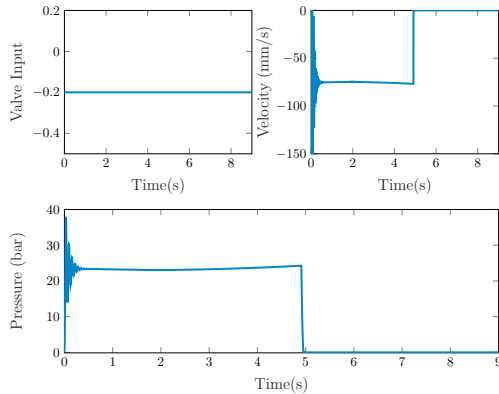

Fig. 6. Valve input, cylinder velocity and cylinder pressure in open-loop.

In Fig. 6, for  $y_v = -0.2$ , the cushion descends at 75 mm/s due to its weight and the constant pressure that is accumulated in the top cylinder chamber. The pressure at the bottom chamber stabilizes at 23 bar. From these data, and together with the valve nominal pressure  $\Delta P_{ref} = 10$  bar and nominal flow  $q_{ref} = 0.01$  m<sup>3</sup>/s we obtain a normalized  $K_v(y_v) = 0.1392$  from Eqs. 1 and 2. This process is repeated for different  $y_v$  until a data set of 50 samples is obtained.

Figure 7 represents the predictive mean, blue line, of the predictive distributions and the gray area represents the upper and lower bounds of the 95% confidence interval of the Gaussian predictive distributions after optimizing the hyperparameters.

After the GP estimation the force reference tracking is improved considerably, however, it still oscillates for valve values from [-0.2,-0.05]. It is, in fact, in this range where the estimation slightly differs from the real valve curve, see Fig. 7. Such a small deviation from the real curve causes a significant inaccuracy in the reference tracking.

An accurate reference tracking would only be possible if the estimation was highly precise. It would require a large amount of training samples in the area of interest and, taking into account the samples noise level, the estimation still would not be perfect. Instead, we add an extra FF signal in the system based on ILC so that at each iteration the valve input signal is adjusted in order to reduce the reference tracking error.

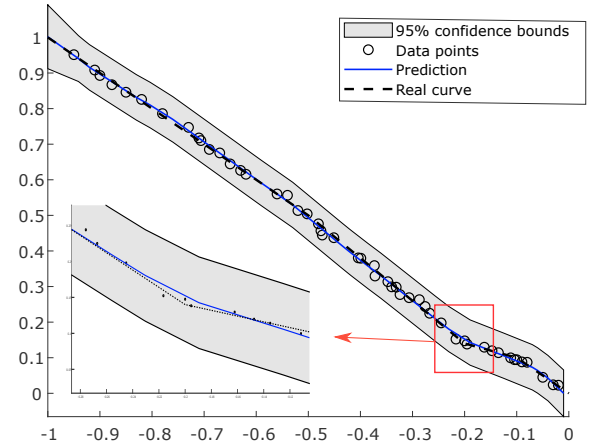

Fig. 7. Gaussian Process prediction after maximizing the negative log-likelihood.

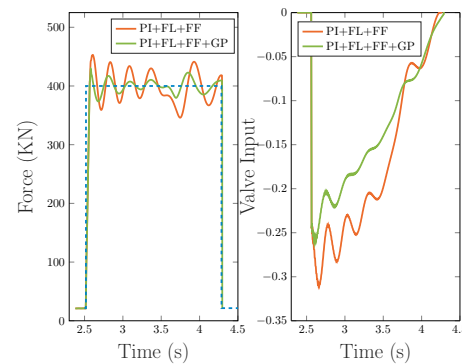

Fig. 8. Force reference tracking and valve input before and after GP prediction.

#### 4. ITERATIVE LEARNING CONTROL

ILC considers systems that perform the same operation repeatedly under the same operating conditions to sequentially improve their performance. Under this concept, hydraulic presses are ideal for this control as they are designed to perform repetitive tasks.

ILC was first introduced by Arimoto in Arimoto et al. (1984), for a mechanical robot operation. The learning control scheme proposed by Arimoto was:

$$U_{j+1}(s) = U_j(s) + L(s)E_j(s). \quad (9)$$

where  $E(s)$  is the Laplace transform of the iteration error,  $L(s)$  is the learning function and  $U(s)$  is the input vector.

As described in Bristow and Tharayil (2006), there exist two possible arrangement for combining ILC with an existing feedback control loop. In the serial arrangement, the control input is applied to the reference before the feedback loop. In the parallel arrangement, the control input is combined with the feedback control signal before it is applied to the system. In this study, the parallel arrangement will be used as the control input calculated by the controllers PI+FF+FL+GP will be updated by the FF signal from the ILC.

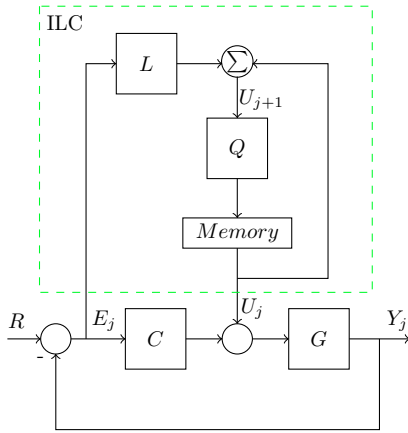

Fig. 9. ILC parallel arrangement added to PI+FL+FF+GP control scheme.

In Fig. 9, the controller  $C$  consists of the PI controller together with FL+FF+GP. The plant  $G$  is the hydraulic system depicted in Fig. 1a and  $Q$  and  $L$  are design filters.

From Fig. 9 the relation between the error at the current iteration with the error at one iteration ahead can be obtained.

$$E_{j+1}(s) = Q(s)(1 - G(s)S(s)L(s))E_j(s) \quad (10)$$

where  $S = \frac{1}{1+GC}$  is the sensitivity transfer function of the system.

A sufficient condition for the stability of the designed ILC was shown in Bristow and Tharayil (2006), which guarantees the system stability and monotonic convergence of the error if:

$$|1 - G(j\omega)S(j\omega)L(j\omega)| < \frac{1}{Q(j\omega)} \quad \forall \omega \in [-\infty, \infty]. \quad (11)$$

From Eq. 10 if the  $L$  filter is designed as  $L = G^{-1} + C$  the error at the second iteration will be zero. However, this design is completely model-dependent as it contains the inverse of the plant. Furthermore, an inverse dynamics model could turn the system unstable, due to unmodeled and non-minimum phase dynamics.

As explained in Sec. 2, there exist uncertainties regarding the dynamics and the hydraulic conductance function of the valve. Therefore, in the design of  $L$  there will be model mismatches penalizing the convergence rate of the ILC algorithm.

A linearized state space is derived combining Eqs. 1 and 2, with the pressure of the cylinder as state and the spool position as input. The resulting  $L$  filter design in the  $s$ -domain after inverting the linearized system dynamics is:

$$L = \frac{s - A}{B} + C \quad \text{where:} \quad \begin{cases} A = -\frac{K_v(\bar{y}_v)}{(V_d + Ax)\beta} \frac{1}{2\sqrt{\bar{P}}} \\ B = -\frac{\sqrt{\bar{P}}}{(V_d + Ax)\beta} \dot{K}_v(\bar{y}_v) \end{cases} \quad (12)$$

where  $\bar{y}_v$  and  $\bar{P}$  are the operating points obtained in steady-state conditions.

Note that the valve dynamics have not been included in the design as they are completely unknown. However, at high frequencies, they will be present and they will affect the controller performance if they are not attenuated.

In the design of  $L$ , two low-pass filters have been included to attenuate the unknown high-frequencies of the valve. Following Elci et al. (1994) non-causal zero phase filtering (ZPF) proposal, the iteration error vector is filtered twice, once in the positive direction of time and another once in the negative direction of time, resulting in ZPF. The new  $L$  filter design with this *back and forth* design results in:

$$L = \frac{s - A_{11}}{A_{12}} \frac{K}{(s - p_1)^2(s + p_2)^2} \quad (13)$$

The frequency response with the designed  $L$  is shown in Fig. 10, at low frequencies the response is close to the plant model, however, as frequency increases the response grows apart from the model.

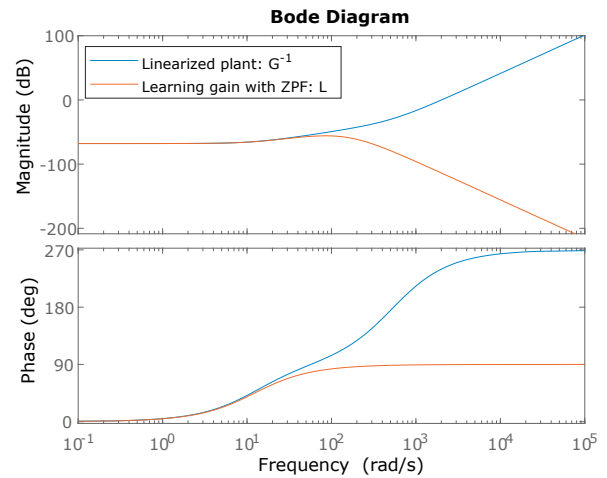

Fig. 10.  $G^{-1}$  and  $L$  Bode diagram.

The backward filtering of the error signal is possible as the ILC input vector is calculated between iterations when the entire iteration error vector is available for processing. The resulting ZPF of  $L$  is shown in Fig. 10, where the unknown high-frequencies are attenuated without losing phase. A  $Q$  gain equal to one is set, in order not to penalize the reference tracking Bristow and Tharayil (2006).

## 5. SIMULATION RESULTS

The designed ILC algorithm has been implemented together to the PI+FF+FL+GP controller. Figure 11 shows the two scenarios considered to validate the algorithm under two different operating points. At the first iteration, in which no ILC signal is added, the signal stabilizes at the start of the step but starts to oscillate as it approaches the end of the step. As explained in Sec. 3, this is due to the uncertainty in the GP estimation of  $K_v(y_v)$ .

As iterations go on, the ILC learns implicitly the exact spool position which stabilizes the force signal. In the region where there existed uncertainty, i.e. within  $[-0.2, -0.05]$ , the ILC has modified the inputs signal smoothing and correcting it, see Fig. 12.

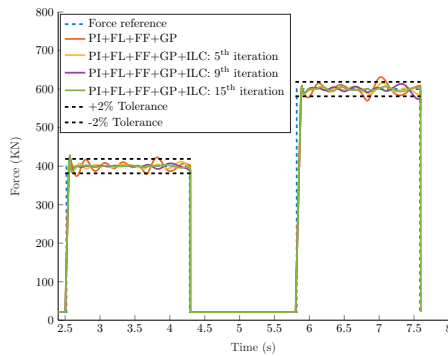

Fig. 11. Force reference for 400 KN and 600 KN step response.

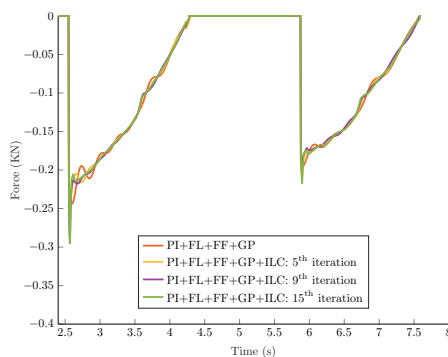

Fig. 12. Control input for 400 KN and 600 KN step response.

## 6. CONCLUSION

Feed-forward (FF) and feedback linearization (FL) controls have been widely used for hydraulic system control, however, when uncertainties are present in the system, these techniques lose efficacy. A Gaussian Process (GP) and Iterative Learning Control (ILC) scheme has been proposed to estimate the uncertainties in the system and improve the system performance respectively.

Regression techniques allow the possibility of estimating the nonlinearities present in the valve based on training samples. However, in a real press operation, it could be difficult to obtain a large amount of training data as it would require too much time to run through all training samples exhaustively, still not guaranteeing a perfect estimation. Therefore, it is deemed a good opportunity for future researches to estimate not only the valve nonlinearities but also the unknown valve dynamics during the normal operation of a press.

ILC design is based on the inverted linearized hydraulic cushion plant. This design has shown robustness as in the linearized model the cylinder position has been considered constant although the cylinder extends and retracts when the valve is opened and closed respectively. Furthermore, the fluid compressibility, considered constant as well, varies due to pressure and temperature changes taking place in the cylinder chamber. It remains for future work to carry out an investigation of the system response under these uncertainties.

Simulation results show that the combination of GP regression and ILC considerably reduces model instability and improves reference tracking performance.

## REFERENCES

- Arimoto, S., Kawamura, S., and Miyazaki, F. (1984). Bettering operation of Robots by learning. *Journal of Robotic Systems*, 1(2), 123–140. doi: 10.1002/rob.4620010203.
- Bai, S., Maguire, J., and Peng, H. (2013). Dynamic Analysis and Control System Design. *SAE international*.
- Bristow, D.A. and Tharayil, M. (2006). A learning-based method for high-performance tracking control. *IEEE Control systems magazine*, 26, 96–114.
- Conrad, F. and Jensen, C. (2017). Design of Hydraulic Force Control Systems with State Estimate Feedback. *IFAC Proceedings Volumes*, 20(5), 307–312. doi:10.1016/s1474-6670(17)55388-4.
- Elci, H., Longman, R.W., Juang, J.n., and Ugoletti, R. (1994). Discrete Frequency Based Learning Control for Precision Motion Control.
- H. Gharib, A.S. Wifi, M. Younan, A.N. (2006). Optimization of the blank holder force in cup drawing. *Journal of Achievements in Materials and Manufacturing Engineering*, 18(1-2), 291–294.
- Honegger, M. and Corke, P. (2001). Model-based control of hydraulically actuated manipulators. *Proceedings - IEEE International Conference on Robotics and Automation*, 3, 2553–2559. doi: 10.1109/ROBOT.2001.933007.
- Ko, J., Klein, D.J., Fox, D., and Haehnel, D. (2007). Gaussian processes and reinforcement learning for identification and control of an autonomous blimp. *Proceedings - IEEE International Conference on Robotics and Automation*, (April), 742–747. doi: 10.1109/ROBOT.2007.363075.
- Manring, N.D., Muhi, L., Fales, R.C., Mehta, V.S., Kuehn, J., and Peterson, J. (2017). Using Feedback Linearization to Improve the Tracking Performance of a Linear Hydraulic-Actuator. *Journal of Dynamic Systems, Measurement, and Control*, 140(1), 011009. doi: 10.1115/1.4037285.
- Merritt, H. (1967). *Hydraulic control systems*. John Wiley & Sons.
- Nakamura, H. and Matsuyama, M. (1998). Throttle valve positioning control apparatus.
- Rahmat, M.F., Zulfatman, Husain, A.R., Ishaque, K., Sam, Y.M., Ghazali, R., and Md Rozali, S. (2011). Modeling and controller design of an industrial hydraulic actuator system in the presence of friction and internal leakage. *International Journal of Physical Sciences*, 6(14), 3502–3517. doi:10.5897/IJPS11.546.
- Visioli, A. (2004). A new design for a PID plus feedforward controller. *Journal of Process Control*, 14(4), 457–463. doi:10.1016/j.jprocont.2003.09.003.
- Williams, Christopher KI and Rasmussen, C.E. (2006). *Gaussian processes for machine learning*. MIT press Cambridge, MA.
- Zhang, R., Alleyne, A.G., and Prasetyawan, E.A. (2002). Performance limitations of a class of two-stage electro-hydraulic flow valves. *International Journal of Fluid Power*, 3(1), 47–53. doi: 10.1080/14399776.2002.10781127.