

Deposición por plasma

DETALLE E
ESCALA 5 : 1

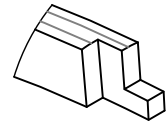

DETALLE A
ESCALA 3 : 1

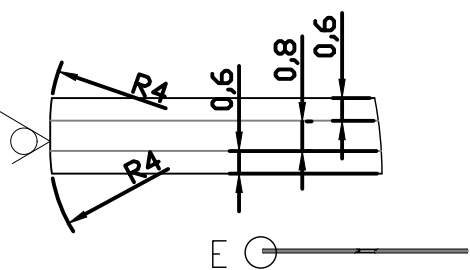
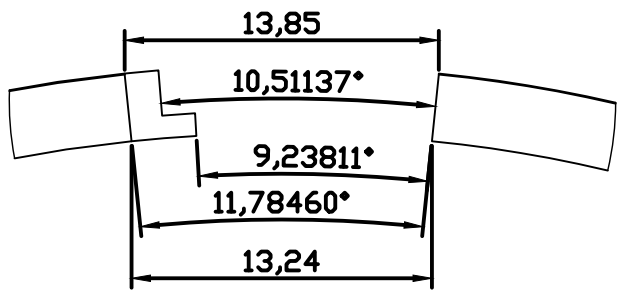
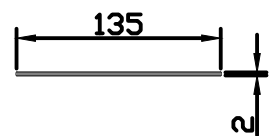
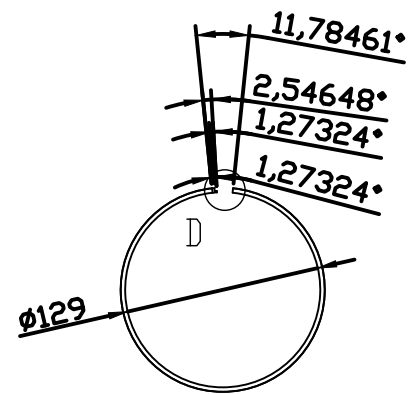
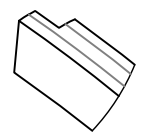

DETALLE D
ESCALA 3 : 1

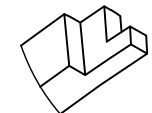
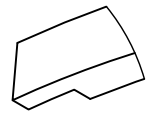
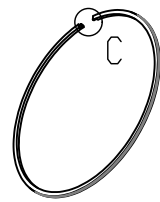

DETALLE C
ESCALA 3 : 1

Material Fundición	Acabado: N1, excepto cara de compresión	Dibujado	Aritz	Lazcano Berrueta	 Universidad del País Vasco / Euskal Herriko Unibertsitatea	BILBOKO INGENIARITZA ESCOLA ESCUELA DE INGENIERIA DE BILBAO
		Comprobado				
Escala 1:5	Segmento de compresión con doble escalonado para eje de 130mm				Nº de plano: 2 de 12	